

# The Basis for Fire Safety

Substantiating fire protection in buildings

Fire Safety Professorship

René Hagen and Louis Witloks



# **The Basis for Fire Safety**

## **Substantiating fire protection in buildings**



## Publication Details

### Authors

René Hagen and Louis Witloks, Fire Safety professorship of the Instituut Fysieke Veiligheid, in close cooperation with various research groups of Brandweer Nederland, the organisation of Dutch fire services.

### Photographs

Cover photo: Jan Beets

Inside photos: René Hagen, Martin de Jongh, Rob Jastrzebski, Jeroen Schokker, Wikimedia and Instituut Fysieke Veiligheid

### Translation

Esperanto WBT

### Support

This publication was also made possible by Underwriters Laboratories and European Fire Safety Alliance (EuroFSA).

The knowledge document entitled ‘**The Basis for Fire Safety**’ was originally written on the basis of the Dutch situation, but in practice, it was soon found to be applicable to situations outside the Netherlands as well. The approach to fire safety as described and elaborated in this document can be applied universally. It describes the backgrounds and provides a substantiation of fire protection measures and facilities. And they also apply internationally, since fire development and fire growth are not specific to just one country. When using this publication for situations outside the Netherlands, please remember that the statistical details stated only concern the Netherlands. Where regulations are referred to, as is specifically the case in chapter 6, this is Dutch legislation. However, the book is definitely suitable for international use as its main focus is on the backgrounds and substantiation of fire safety measures and facilities which are based on fire development, the spread of smoke, the behaviour of constructions and people’s behaviour when fleeing a building, instead of on statutory requirements.

First edition, second unchanged reprint, February 2018

© Instituut Fysieke Veiligheid

You may copy information from this publication, provided that you state its source.

Whilst every care has been taken in the compilation of the text, the editors cannot accept liability for any damage or loss arising from any inaccuracies or mistakes that might occur in this publication.

Instituut Fysieke Veiligheid

P.O. Box 7010

6801 HA Arnhem

The Netherlands

T +31 (0)26 355 24 00

[www.ifv.nl](http://www.ifv.nl)

ISBN/EAN 9789056434663

## Foreword





The Netherlands Institute for Safety in Arnhem, the Netherlands

## Foreword

This publication, *The Basis for Fire Safety*, is a knowledge document providing substantiation, argumentation and background information about fire prevention. It is intended as a reference book and a practical manual. The publication offers a conceptual framework for and an approach to the fire protection of buildings, based on Dutch statutory schemes such as the Housing Act (*Woningwet*), Working Conditions Act (*Arbowet*) and the Safety Regions Act (*Wet veiligheidsregio's*) and on scientific knowledge. This is a monodisciplinary document by the Organisation of Dutch Fire Services that connects the individual elements of fire prevention. The publication emphasises an integral approach that is necessary in order to improve the quality of fire prevention. As the series of fire protection concepts published by the former Dutch Ministry of the Interior in the 1990s became obsolete, there was no longer an up-to-date document that provided for this.

The current document deals with integral fire safety at the level of buildings. As it is not a summary of methods by which fire prevention is implemented in practice, no attention is given to important aspects of this, such as fire-safe living, supervision and enforcement.

Besides being a source of knowledge for the fire service, this knowledge document may also serve as:

- background information for the government in its capacity of legislator as regards building regulations
- a tool that will help market participants and the government, in its role of licensing authority, to decide on equivalent solutions, FSE solutions and risk approach
- a tool that will enable market participants to provide an insight into fire prevention, so that they can fulfil their own responsibilities for this.

This document has three parts. Part A is the core of the document. It first describes the systematic approach to fire prevention, the conceptual framework. The rule-based and risk-based approaches and their interrelationship are then discussed, where it should be noted that this order does not imply any preference for or priority of approaches and methods. Part A produces a summary of the fire protection measures and facilities per risk group and the associated building purposes and functions.

Part B sketches the frameworks for fire safety, making it the underlying substantiation of the conceptual framework and the approach from part A.

These frameworks have four parts:

- The risks in the event of fire that indicate the frameworks for why fire protection is actually to be implemented and on which basis.
- The objectives from statutory regulations that require protection according to the government.
- The scientific substantiation of the measures and facilities that are applied in the real world situation.
- Fire behaviour to the extent that this is important for fire prevention facilities.

Part C contains the annexes: a profile of the various building purposes and functions that have been differentiated in this publication, the escape safety analysis model and a summary of recent and relevant cases where preventative facilities played a role in the fire behaviour and the outcome of the incident. Prior studies and publications have been used for this document. They are listed in the last annex, the bibliography.

The Dutch terms for fire prevention (i.e. *brandpreventie*) and fire protection (i.e. *brandbeveiliging*) have been subject to regular discussions by professionals. As early as in 1949, the former Dutch *Taalcommissie voor de Techniek* (Language Committee for Technique) studied these terms, but without any result. The definitions subsequently used in various glossaries have not been unanimously approved of either. That is why this publication uses these two terms in the same, generally recognisable meaning.

No additional studies have been carried out for drawing up this document, nor was this part of the assignment. However, it has been noted that scientific substantiation or an evidence base is lacking in many fields. But this does not imply that fire prevention requirements, measures and facilities are not useful, as practical experience has been gained with them for dozens of years, as a result of which scientific substantiation is sometimes no longer necessary. But this is not a general truth. Investing in scientific substantiations in order to fill gaps in knowledge continues to be necessary. If this is not done to a sufficient extent, it will frustrate innovation. An example of this is the *Beheersbaarheid van brand* (Controllability of Fire) calculation model. This model is based on existing knowledge and has not developed any new knowledge. In real-life practice, this has resulted in many discussions about the model and in increasing resistance to its application, both between the government and advisers to market participants, and between different advisers. The valuable *Brandveilig Leven* (Fire-safe Living) process initiated by the Dutch Fire Services also threatens to come to a standstill due to a lack of scientific substantiation. Therefore, it is all the more remarkable that a current scientific research result on human behaviour in the event of fire is not used as the basis to adjust statutory requirements.

This knowledge document is the result of developments in the past few decades. Various sources were consulted and used when compiling this document, including those listed in annex D. So as not to frustrate the

legibility of this reference work and manual, no footnotes have been included in the text to identify the sources.

This document is ready for the future. This means that it is both in line with current prescriptive regulations, in which thresholds and reducing effects play an important role, and that it will be compatible with a possible future performance system of regulations, based on risks and fire safety engineering. It is also a living document which will have to be updated every now and then to incorporate new knowledge and experience.

This knowledge document is composed as follows:

## **A: Conceptual framework and approach to fire safety**

### **Chapter 1**

**Conceptual framework for fire prevention**

### **Chapter 2**

**Fire prevention: from rule-based to risk-based**

### **Chapter 3**

**Risk-based fire prevention (FSE)**

### **Chapter 4**

**Fire safety measures and facilities**

## **B: Fire safety frameworks**

### **Chapter 5**

**Risks in the event of a fire**

### **Chapter 6**

**Statutory framework and objectives of fire prevention**

### **Chapter 7**

**Evidence base in a historical framework**

### **Chapter 8**

**Fire and fire development**

## **C. Annexes**

### **Annex A**

**Building profiles**

### **Annex B**

**Escape safety analysis model**

### **Annex C**

**Case histories of fires**

### **Annex D**

**Bibliography**





# Contents





High-rise building in Rotterdam

# Contents

<b>Foreword</b>	<b>3</b>
<b>Introduction</b>	<b>17</b>
<b>Chapter 1</b>	
<b>Conceptual framework for fire prevention</b>	<b>25</b>
<b>Introduction</b>	<b>27</b>
<b>1. Conceptual framework</b>	<b>27</b>
<b>2. Summary of characteristics</b>	<b>29</b>
<b>2.1 Approach from five disciplines</b>	<b>29</b>
<b>2.2 Interactions of characteristics: an explanation</b>	<b>34</b>
<b>2.2.1 The interaction between fire characteristics and building characteristics</b>	<b>34</b>
<b>2.2.2 The interaction between human characteristics and building characteristics</b>	<b>35</b>
<b>2.2.3 The interaction between fire characteristics and human characteristics</b>	<b>35</b>
<b>2.2.4 The interaction between intervention characteristics and fire, building and human characteristics</b>	<b>35</b>
<b>2.2.5 The interaction between environmental characteristics and fire, building and human characteristics</b>	<b>36</b>
<b>3. Summary of fire events</b>	<b>36</b>
<b>3.1 From event to protection objective</b>	<b>37</b>
<b>3.2 Specifying protection objectives</b>	<b>39</b>
<b>4. Fire service intervention time</b>	<b>41</b>
<b>5. Context of the fire prevention</b>	<b>42</b>
<b>6. Fire safety balance</b>	<b>44</b>
<b>7. Method using the conceptual framework</b>	<b>45</b>
<b>Chapter 2</b>	
<b>Fire prevention: from rule-based to risk-based</b>	<b>47</b>
<b>Introduction</b>	<b>49</b>
<b>1. Rule-based fire prevention</b>	<b>49</b>
<b>1.1 Equivalence</b>	<b>51</b>
<b>1.2 Fire development as a basic assumption</b>	<b>52</b>
<b>1.3 Normative fire development</b>	<b>54</b>
<b>1.4 Translating the normative fire development into protection options</b>	<b>56</b>
<b>1.5 Comparison of rule-based fire prevention with the conceptual framework</b>	<b>56</b>
<b>2. From rule-based to risk-based</b>	<b>60</b>
<b>2.1 Consideration</b>	<b>63</b>
<b>2.2 Fire prevention triangle</b>	<b>64</b>

<b>3.</b>	<b>Risk-based fire prevention</b>	<b>65</b>
<b>3.1</b>	<b>Natural fires</b>	<b>65</b>
<b>4.</b>	<b>The cascade model</b>	<b>66</b>
<b>4.1</b>	<b>First cascade</b>	<b>68</b>
<b>4.2</b>	<b>Second cascade</b>	<b>69</b>
<b>4.3</b>	<b>Third cascade</b>	<b>71</b>
<b>4.4</b>	<b>Fourth cascade</b>	<b>73</b>
<b>4.5</b>	<b>Fifth cascade</b>	<b>74</b>

## **Chapter 3**

	<b>Risk-based fire prevention (FSE)</b>	<b>75</b>
	<b>Introduction</b>	<b>77</b>
<b>1.</b>	<b>Fire safety engineering</b>	<b>78</b>
<b>1.1</b>	<b>Conceptual thinking</b>	<b>78</b>
<b>1.2</b>	<b>Expert opinion</b>	<b>79</b>
<b>1.3</b>	<b>Project analysis</b>	<b>79</b>
<b>1.4</b>	<b>Fire safety engineering: a risk-based method</b>	<b>80</b>
<b>2.</b>	<b>Fire safety engineering in practice</b>	<b>84</b>
<b>2.1</b>	<b>Six-step risk approach</b>	<b>86</b>
<b>2.2</b>	<b>Risk analysis methods as part of risk approach</b>	<b>91</b>
<b>2.2.1</b>	<b>Probability-impact matrix</b>	<b>91</b>
<b>2.2.2</b>	<b>Event tree</b>	<b>91</b>
<b>2.2.3</b>	<b>Risk analysis method as part of risk approach</b>	<b>91</b>
<b>2.3</b>	<b>Fire scenarios</b>	<b>92</b>
<b>2.3.1</b>	<b>Fire as part of the scenario</b>	<b>93</b>
<b>2.3.2</b>	<b>Evacuation as part of the scenario</b>	<b>93</b>
<b>2.4</b>	<b>FSE tools</b>	<b>95</b>
<b>2.4.1</b>	<b>Fire models</b>	<b>96</b>
<b>2.4.1.1</b>	<b>Fire characteristic</b>	<b>98</b>
<b>2.4.1.2</b>	<b>Influencing the fire characteristic</b>	<b>100</b>
<b>2.4.1.3</b>	<b>Smoke</b>	<b>100</b>
<b>2.4.1.4</b>	<b>Plume model</b>	<b>102</b>
<b>2.4.1.5</b>	<b>Type of fire: fuel-controlled – ventilation-controlled</b>	<b>103</b>
<b>2.4.2</b>	<b>Innovative fire models</b>	<b>105</b>
<b>2.4.2.1</b>	<b>Single-zone models and two-zone models</b>	<b>106</b>
<b>2.4.2.2</b>	<b>Field models</b>	<b>107</b>
<b>2.4.3</b>	<b>Evacuation models</b>	<b>107</b>
<b>2.4.3.1</b>	<b>Evacuation models</b>	<b>107</b>
<b>2.4.3.2</b>	<b>Analysis model for escape safety</b>	<b>108</b>
<b>2.4.4</b>	<b>Models for fire detection element activation times</b>	<b>109</b>
<b>2.4.5</b>	<b>Models for structural safety (fire resistance until structural failure)</b>	<b>109</b>
<b>2.4.6</b>	<b>Consideration of FSE tools and recommendations</b>	<b>111</b>
<b>3.</b>	<b>Process and method</b>	<b>111</b>
<b>3.1</b>	<b>Process model</b>	<b>111</b>
<b>3.1.1</b>	<b>Informal discussions on the approach to equivalent safety</b>	<b>112</b>

3.1.2	Formal procedure	112
3.1.3	Interaction: informal discussions – formal procedures	112
3.1.3.1	Quick scan report	113
3.1.3.2	Report on scenarios, risks and protection options	114
3.1.3.3	Final report on equivalent fire safety	115
3.2	Anchoring in formal permit procedure	115
3.3	Delivery report	116
3.4	Enforcement	116
3.5	Quality of reports	116
3.6	Disputes regarding reports	118

## Chapter 4

	Fire safety measures and facilities	119
	Introduction	121
1.	Phases of normative fire development, plus basic assumptions	122
1.1	Group 1 - People who are able to leave without assistance	124
1.2	Group 2 - People who can leave without assistance, sleeping	130
1.3	Group 3 - People who are not able to leave without assistance, sleeping	132
1.4	Group 4 - People who can leave without assistance, sleeping - homes and residential buildings	136
2.	Fire protection measures and facilities	139
2.1	Preventing fire	142
2.2	Early discovery of a fire	147
2.3	Raising the fire alarm as quickly as possible	149
2.4	Timely evacuation/fleeing in case of a fire	151
2.5	Action by the in-house emergency responders, staff and residents to extinguish an incipient fire	157
2.6	Automatically suppressing a fire as quickly as possible	158
2.7	Reporting a fire as quickly as possible	160
2.8	to 2.11 Intervention by the fire service as quickly, safely, and effectively as possible	163
2.12	Providing after-care as quickly and effectively as possible	169
3.	Fire safety balance	170
3.1	Influencing the evacuation time	170
3.1.1	Safer stairwells	171
3.1.2	Shortening the discovery time	172
3.1.3	Automatic suppression	172
3.2	Influencing the intervention time	172
3.2.1	Facilities that will increase the intervention speed	173
3.2.2	Shortening the discovery and reporting times	173

3.2.3	Deploying an efficient in-house fire service	173
3.2.4	Reducing the deployment of the fire service	174
4.	<b>In-house emergency responders, risk assessment and evaluation</b>	<b>174</b>
4.1	Additional fire risk assessment and evaluation	175
4.2	Phased plan for additional risk assessment and evaluation for fires	177

## Chapter 5

	<b>Risks in the event of a fire</b>	<b>181</b>
	<b>Introduction</b>	<b>183</b>
1.	<b>What is fire risk?</b>	<b>184</b>
1.1	Risk perception	185
1.2	Acceptance of risks	185
2.	<b>Controlling fire risks: the 'bow tie' model</b>	<b>187</b>
3.	<b>Risk control methods</b>	<b>188</b>
3.1	Deterministic approach	188
3.2	Probabilistic approach	189
3.3	Quantitative or qualitative	189
4.	<b>People both posing and carrying the risk</b>	<b>192</b>
4.1	Not being able to leave without assistance in the event of a fire	193
4.2	People's ability to leave without assistance and their behaviour	194
5.	<b>Classification of fire risks in buildings</b>	<b>197</b>
5.1	<b>Classification of risks</b>	<b>198</b>
5.1.1	The building	199
5.1.2	The circumstances of people's presence in the building	199
5.1.3	Occupancy aspects	202
5.1.4	The human factor	202
6.	<b>Translating risks into protection options</b>	<b>202</b>
6.1	Fire scenarios	203
6.2	Probability-impact matrix	204
6.3	Event tree	205
7.	<b>Risks and buildings</b>	<b>208</b>
8.	<b>Fire causes and consequences</b>	<b>214</b>
8.1	Causes and effects per type of building	214
8.2	Risks for fire service personnel	216

## Chapter 6

	<b>Statutory framework and objectives of fire prevention</b>	<b>217</b>
	<b>Introduction</b>	<b>219</b>
1.	<b>General assumptions for fire prevention in buildings</b>	<b>219</b>
2.	<b>The public domain</b>	<b>220</b>
2.1	<b>Building regulations</b>	<b>220</b>

2.1.1	Environmental Permitting (General Provisions) Act	220
2.1.2	Housing Act and Building Decree	221
2.1.3	Municipal building regulations	222
2.1.4	Objective and basic assumptions of building regulations	222
2.2	Regulations on working conditions	223
2.2.1	Dutch Working Conditions Act and Working Conditions Decree	223
2.2.2	In-house emergency response	224
2.2.3	Working conditions catalogue	225
2.3	Regulations on the provision of fire services	226
2.3.1	Safety Regions Act and Safety Regions Decree	226
2.3.2	Assessment of fire risk	229
3.	Private domain	230
3.1	Preventing damage and loss	230
3.2	Interactions between the public and private domains	231
4.	Review of statutory schemes and their interrelationships	231
5.	Main objectives of fire prevention in buildings	234

## Chapter 7

	Evidence base in a historical framework	235
	Introduction	237
1.	The development of fire prevention	237
2.	Evidence base	239
2.1	Fire resistance	241
2.2	Fire load	242
2.3	Compartmentation	244
2.4	Structural safety	245
2.5	Safe evacuation	246
2.6	General assumptions for determining fire resistance values	249
3.	New impetuses	250

## Chapter 8

	Fire and fire development	253
	Introduction	255
1.	The inception of fire	255
2.	Combustion products	256
3.	Fire spread in the room	258
3.1	Growth stage	258
3.2	Fully developed stage	260
3.3	Smouldering stage	260
3.4	Characteristics of fire development in a closed room	261
4.	Further fire spread	262
4.1	Heat transport	262



<b>Annex A</b>	
<b>Building profiles</b>	<b>265</b>
<b>Annex B</b>	
<b>Escape safety analysis model</b>	<b>295</b>
<b>Annex C</b>	
<b>Case histories of fires</b>	<b>313</b>
<b>Annex D</b>	
<b>Bibliography</b>	<b>337</b>

# Introduction





High-rise building in Nijmegen Dukenburg



## Introduction

### Fire protection concepts

In the 1980s, several Acts laid the basis for fire safety requirements in the Netherlands. The main acts were the Dutch Housing Act (*Woningwet*), the Fire Services Act (*Brandweerwet*), the Nuisance Act (*Hinderwet*; which later became the Environmental Management Act (*Wet milieubeheer*)) and the Working Conditions Act (*Arbeidsomstandighedenwet*). As the objectives and provisions of these Acts were based on several different perspectives, the required level of fire safety was not always achieved because there was no or insufficient coordination between the different fire safety requirements that were based on the various regulations. In the early 1990s, the Dutch government realised that a framework should be developed that enabled an integrated approach to fire safety. These frameworks were developed under the heading of 'fire protection concepts'. A fire protection concept was developed for every individual building purpose or 'building function'.

A fire protection concept highlights basic areas that require special attention for fire protection measures and facilities, divided into such themes as town and country planning, architecture, technical systems, furnishings, internal organisation and use and deployment of the fire service. The fire protection concepts served a dual function. On the one hand, governments could use them as a general guideline when incorporating fire protection requirements in their regulations. On the other hand, they offered everyone involved with fire safety, such as governments, designers, insurers, and users, an insight into the interrelationships between the various fire protection measures and facilities. In retrospect, the fire protection concepts have only served as the basis for outlining fire protection measures and facilities in regulations to a limited extent, since the perspectives of the various ministries involved differed too much.

But it can be concluded that the other objectives of the fire protection concepts have been achieved, and have been of great added value to achieving cohesive fire safety. However, since the fire protection concepts were introduced, legislation and regulations for fire safety have changed several times, such as by the revised Dutch Building Decrees of 2003 and 2012, the implementation of requirements for fire-safe use of buildings and the arrival of the Safety Regions Act (*Wet veiligheidsregio's*). And dramatic incidents such as the pub fire in Volendam in 2001, the fire in the cell complex at Schiphol in 2005 and the fire in the Rivierduinen institute for mental healthcare in Oegstgeest in 2011 have resulted in significant changes to people's perspectives of fire safety and the context within which fire prevention policy is implemented.

## A new perspective on fire protection concepts

In 2005, the Dutch Ministry of the Interior and Kingdom Relations commissioned an assessment of the existing fire protection concepts. Prompted by the fire in the cell complex at Schiphol, where 11 people lost their lives, a start was quickly made to update the fire protection concept for cells and buildings housing cells. As had been the case with the existing fire protection concepts, this new fire protection concept had come into being in close conjunction with the ministries and actors involved. The updated fire protection concept significantly contributed to bringing fire safety in penitentiary facilities up to par. After the fire protection concept for cells and buildings housing cells had been updated, a speedy start was made to update the fire protection concept for healthcare buildings.

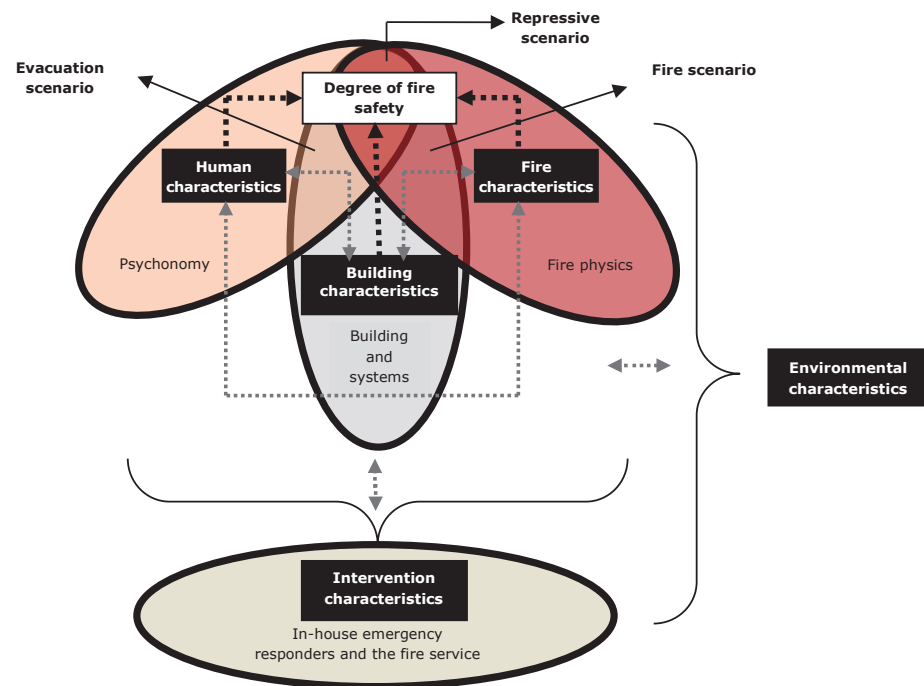
While updating this latter fire protection concept, it was increasingly found that the existing set-up of the series of fire protection concepts no longer matched the national government's new view of fire safety. In response to the Schiphol fire, the government implemented a Fire Safety Action Programme in which a new vision of fire safety was sketched. This vision is based on several pillars of which a risk-based approach, own responsibility, a target group-based approach and quantifying objectives are the main ones. This means that not only have fire safety regulations and legislation changed drastically since the introduction of the fire protection concepts, but the context in which the policy is implemented has turned around as well. A move away from prescriptive implementation of generally applicable fire protection measures and facilities towards an approach based on attendant risks has started. And this has also helped bring about an approach to fire safety based on fire safety engineering. This also implied that, even more than ever before, a good understanding of the basic assumptions of fire protection is essential.

The government's decision that it no longer wishes to play a role in pseudo-regulations, as the fire protection concepts were often perceived, was also an influential factor. All this led to the development of a renewed perspective on fire safety, aligned with current social developments. Mere updating had become out of the question. In 2009, the former Regional Chief Fire Officers Council (*Raad van Regionaal Commandanten*) decided that the fire protection concepts should become guidelines for experts, with the status of that of a manual or guide. This decision of the Council, combined with the intention to create one document instead of separate documents for each individual building purpose, as had been the case with the old fire protection concepts, of course had drastic consequences for the contents of and approach to the existing series of fire protection concepts. This led to the idea of a new publication 'The Basis for Fire Safety' that should replace the existing series of fire protection concepts.

## Basic assumptions of this knowledge document

The current series of fire protection concepts takes the details of fire protection for the different building purposes as its starting point. This new knowledge document links the degree of fire protection to normative risk factors and scenarios rather than to specific building purposes.

The normative risk factors are clustered by risk factors that result from the characteristics of the people present in the building, the structural characteristics and the usage characteristics of the physical environment where people are present and the physical characteristics of fire and smoke development. Intervention in the event of fire in the form of the response of the in-house emergency responders and the fire service (intervention characteristics) plays a role in this, as does the geographic location of the building in relation to fire safety in the building (environmental characteristics). A schematic view of the interrelations of the various characteristics is presented in figure 1.



**Figure 1** Schematic view of the interrelationships of the various characteristics

The interrelationships of the characteristics form an integrated system that determines the degree of fire safety. The norm for fire safety is determined by one or several fire scenarios. These scenarios can be influenced by means of fire protection measures and/or facilities. For instance, the fire characteristics in a building with a sprinkler system will differ from those in a building without a sprinkler system. The physical environment also influences the fleeing or evacuation behaviour of people who are physically able to leave the building without assistance. The evacuation scenario in a public area will differ from that in a closed environment, such as a cell complex. Besides this, the repressive scenario also plays an important role. Rapid fire development, for example, will imply different options for fighting the fire and saving people than a relatively slow fire development. The need for a repressive attack by the fire service is different when the building has been evacuated fast, than when there are still lots of people in the burning structure. To be able to improve the fire safety level, specific fire protection measures and facilities can be implemented based on a risk analysis and a scenario analysis. This document offers the appropriate methods and basic assumptions for this.

The knowledge and experience gained from the current fire protection concepts have been used as the basis for this document. For example, the specific objectives of fire protection and the risk model of the event tree with fire scenarios used in the fire protection concepts have been developed further. As a result, the link between events in the scenarios and fire protection measures and facilities that affect these events has been maintained. Besides using the current fire protection concepts as the basis, new developments for fire protection have also been taken into account. New knowledge and insights have been incorporated into this document. The publication *‘Zelfredzaamheid bij brand, kritische factoren voor het veilig vluchten uit gebouwen’* (Being able to leave without assistance in the event of a fire: critical factors for fleeing safely from buildings) by Margrethe Kobes, a researcher at the Netherlands Institute for Safety (NIFV), deserves special attention. Her thoughts served as the model for substantial parts of this knowledge document ‘The Basis for Fire Safety - Substantiating fire protection in buildings’.

### Use of this knowledge document

This publication presents a framework for legislators, designers, builders and users of buildings. It contains a system of interrelated fire protection measures and facilities, and further explanations of the backgrounds. This document enables the many actors involved in fire protection of buildings to recognise and apply the interrelationships between fire safety measures and facilities and to effectively influence the details of integrated fire protection as part of their own responsibility. Dependence on the various links in the chain plays an important role. The use of this publication should prevent any aspects of fire safety from being neglected. It enables responsible choices to be made to ensure fire safety during the interrelated design, construction and use phases.

This document is not only a source of information for designers and builders, but it should also be used as a framework for any future legislation and regulations as it addresses both the background information for the current system of prescribed rules and a future system based on a risk-based approach. It is also a source document that will enable municipal authorities and safety regions to take policy decisions as regards the implementation of fire service tasks. It offers the managers and users of buildings who are responsible for fire safety in buildings the opportunity to professionally influence the content of that fire safety. An integrated approach to fire safety in terms of architectural and organisational aspects and technical systems is essential in this respect. The in-house emergency response organisation has a crucial role and position in this. These emergency responders have important tasks, such as evacuating people, and meeting and accompanying the professional emergency services. Especially in buildings with people who are not fully able to leave without assistance, e.g. in buildings housing cells and in healthcare buildings, the in-house emergency response organisation has a heavy responsibility.

## Vision of fire prevention for the future

This document addresses cohesive fire safety at the level of buildings. Working methods have changed significantly in recent years. The lessons learnt from the fire at the 't Hemeltje pub in Volendam in 2001, where 14 people were killed and some 250 people were injured, were still aimed at improving the prevailing fire safety system. After the fire in the cell complex at Schiphol in 2005, there was growing awareness that the limits of the system had been reached. The Dutch national government then also realised that adding more rules and intensifying enforcement would not improve fire safety any further. A new course was embarked on. This course was set out in 2007 in the inaugural speech '*Het kerkje van Spaarnwoude*' (The Spaarnwoude church) by the Fire Prevention professor at the former Netherlands Institute for Safety (NIFV) and was further translated into the Fire Safety Action Programme (2009) initiated by the then government. Improving fire safety by introducing a risk-based approach, quantifying objectives, a target group-based approach and strengthening civilians' and companies' own responsibility became the main thread connecting the various aspects.

This was also the period when the Dutch fire service drew up a vision for the future for its organisation and tasks, entitled *Brandweer over morgen* (Fire Service for Tomorrow). Two of these basic assumptions ended up in this vision: putting more effort into fire prevention and innovating repressive firefighting. This latter element was also due to the results of the study of the fire in a boathouse at De Punt in 2008, where three firefighters were killed. An important and prominent result of an increased focus on fire prevention was the *Brandveilig leven* (Fire-safe Living) project. Following the British example, this project mainly focuses on improving fire safety in the home by such initiatives as expanding the range covered by smoke detectors in homes, the fire service paying visits to people's homes and by giving information, both before and after fires.

Innovating repressive firefighting has resulted in the *Brandweerdoktrine* (Fire Service Doctrine) project, the first result of which was the 4-quadrants model. This has given the fire service the opportunity to choose from several tactics to fight fires, ranging from an offensive to a defensive attack strategy and from fighting the fire inside the building to fighting the fire from the outside. This tool, which is repressive by nature, also has a close link to fire prevention, since the choice of the manner of firefighting not only depends on the fire characteristics and the risks to be identified, but also depends on the building characteristics, including the fire prevention facilities. And furthermore, the development of the Fire Service Doctrine has resulted in the awareness that, contrary to common practice, it is highly undesirable to take deployment of the fire service into account when determining which fire protection measures and facilities should be implemented in a building. The *Beheersbaarheid van Brand* (Controllability of Fire) calculation model is an example of this.





# Chapter 1

## Conceptual framework for fire prevention





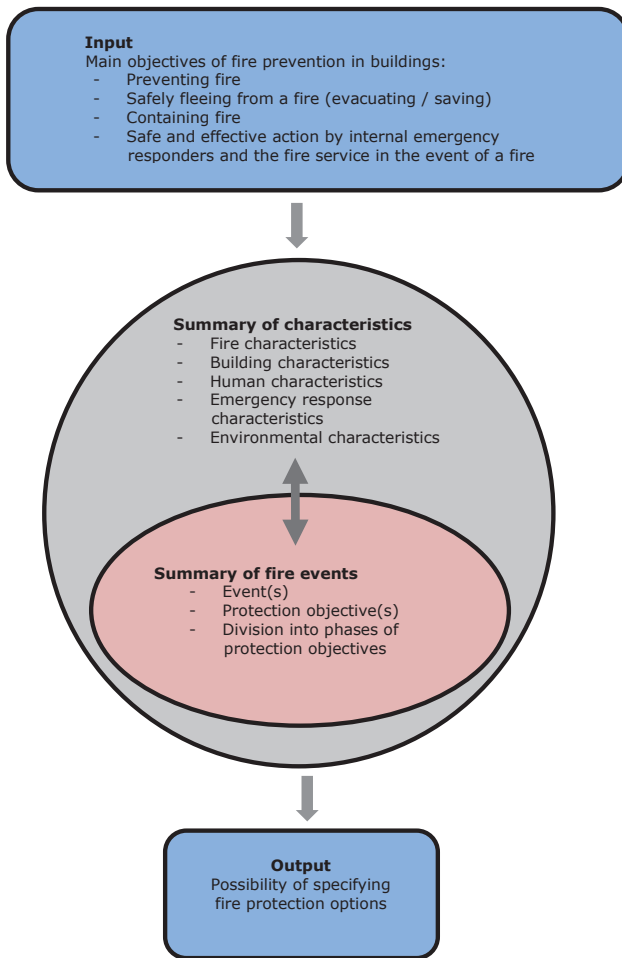
## Introduction

Implementing fire prevention in practice is concerned with translating its objectives into concrete fire protection measures and facilities. Given the many factors that play a role here, this requires a model-based method, a 'conceptual framework'. The conceptual framework is described, further explained, and represented in diagram form by means of the summary of characteristics and the summary of fire events in section 1. The summary of characteristics discussed in section 2 concerns the approach to fire safety based on fire, building, human, intervention, and environmental characteristics, and their mutual relationships. The summary of fire events in section 3 provides an insight into the course of events in the case of a fire and links them to the corresponding protection objectives using a subdivision into phases for a particular fire development. The fire service's intervention time is discussed in more detail in section 4. Section 5 emphasises the context of fire prevention, partly from the perspective that absolute safety cannot be assured and that we should not pretend that it does. The safety balance in section 6 explains the interchangeability of fire safety measures and facilities. And finally, section 7 conveys the method of using the conceptual framework from the perspective of verification.

### 1. Conceptual framework

Converting the main objectives into concrete fire protection measures and facilities requires an understanding of the risks that play a role in a fire (see chapter 5). This conversion is not easy since very many factors are at work here. The factors can therefore only be clarified by following a model-based approach that can then also serve as a conceptual framework for fire protection in buildings. The summary of characteristics and the summary of fire events play a central role in the conceptual framework. The summary of characteristics concerns the approach to fire safety based on fire, building, human, intervention and environmental characteristics. The summary shows the interrelationships between, and the influences on, the characteristics and the events that occur during a fire. The summary of fire events provides an insight into the events in case of a fire from the moment a fire starts until and including the provision of after-care. The events indicate the protection objectives and how they may be influenced by means of fire safety measures or facilities. An example of a protection objective is 'timely evacuation and/or fleeing'. Linking the protection objectives to a certain phased fire development, a scenario, enables effective protection options to be determined. It is important that the specific characteristics from the summary of characteristics, such as human behaviour, are taken into account.

Figure 2 shows a diagram of the conceptual framework.



**Figure 2** Diagram of the conceptual framework for fire prevention

The model's input consists of the main objectives of fire prevention in buildings (see chapter 6). The risks are explored and the relevant concrete fire protection options are defined using the summary of characteristics and the summary of fire events.

## 2. Summary of characteristics

The summary of characteristics derived from the study entitled ‘*Zelfredzaamheid bij brand: kritische factoren voor het veilig vluchten uit gebouwen*’ (Being able to leave without assistance in the event of a fire: critical factors for fleeing safely from buildings) is central to the conceptual framework for fire prevention described here. In this study, which primarily focuses on escape safety, repression is one of the characteristics of fire. Intervention in the event of a fire has been listed as a separate characteristic in the diagram of characteristics. The group of environmental characteristics has also been added to provide more clarity and in the interest of later elaboration of the areas that require special attention for fire protection measures and facilities in chapter 4. The parts in this chapter describing the building characteristics, the fire characteristics and the human characteristics, as well as the descriptions of the interactions among these characteristics, have been copied from this study.

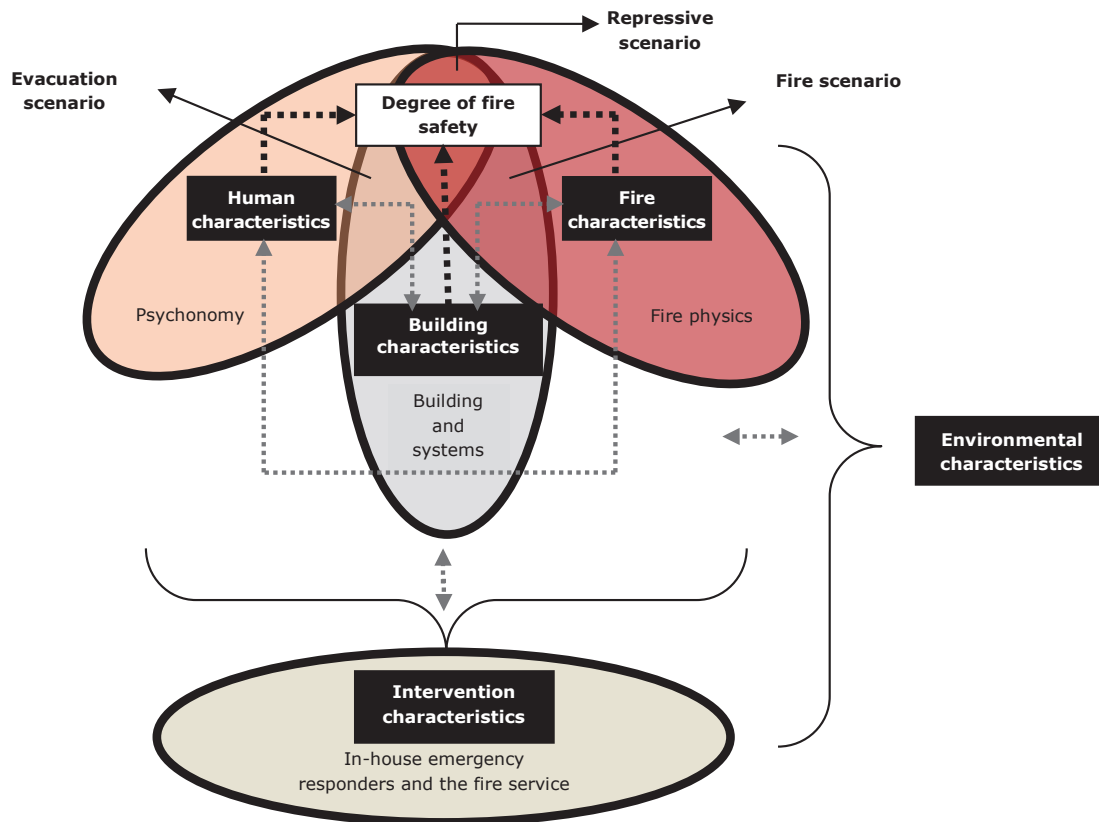
The summary of characteristics as shown in figure 3 concerns an assessment system. This is actually ‘applied fire safety science’, which is the assessment of:

- the typical characteristics of a fire (fire physics)
- a building's design (construction engineering and architecture)
- people's behaviour in relation to fire safety
- emergency assistance by internal and external emergency responders in the event of a fire
- environmental factors in relation to fire safety.

### 2.1 Approach from five disciplines

Fire safety is approached from five interrelated disciplines. These disciplines are:

- Fire safety physics – fire characteristics: the start, growth and effects of fire.
- Structural fire safety engineering – building characteristics: the architectural and structural design of the building and its systems related to the occurrence, growth and effects of a fire and the ability to flee from a fire.
- Fire safety psychonomics – human characteristics: the interactions between the surroundings and the behaviour of people in these surroundings.
- Fire intervention science – intervention characteristics: the intervention in the event of a fire in the form of the response by the fire service and the in-house emergency responders.
- The influence of the environment on fire safety – environmental characteristics: the location of the building in relation to fire safety in the building.



**Figure 3** Summary of characteristics

### Fire safety physics

Fire safety physics is concerned with fire growth and fire effects. The fire is the central element. Fire curves and fire scenarios play a crucial role in fire growth. A fire curve is a representation of how a fire grows over time. Fire growth can be expressed in terms of temperature, radiation value, calorific value, toxic value, etc. A fire scenario describes the growth of fire related to the characteristic properties of an object, such as a building. Fire effects refer to such aspects as the consequences of heat and smoke for people and the building. Fire safety physics is about how human and fire characteristics, and building and fire characteristics influence each other. You can find more information about fire curves in chapter 2.



### *Structural fire safety engineering*

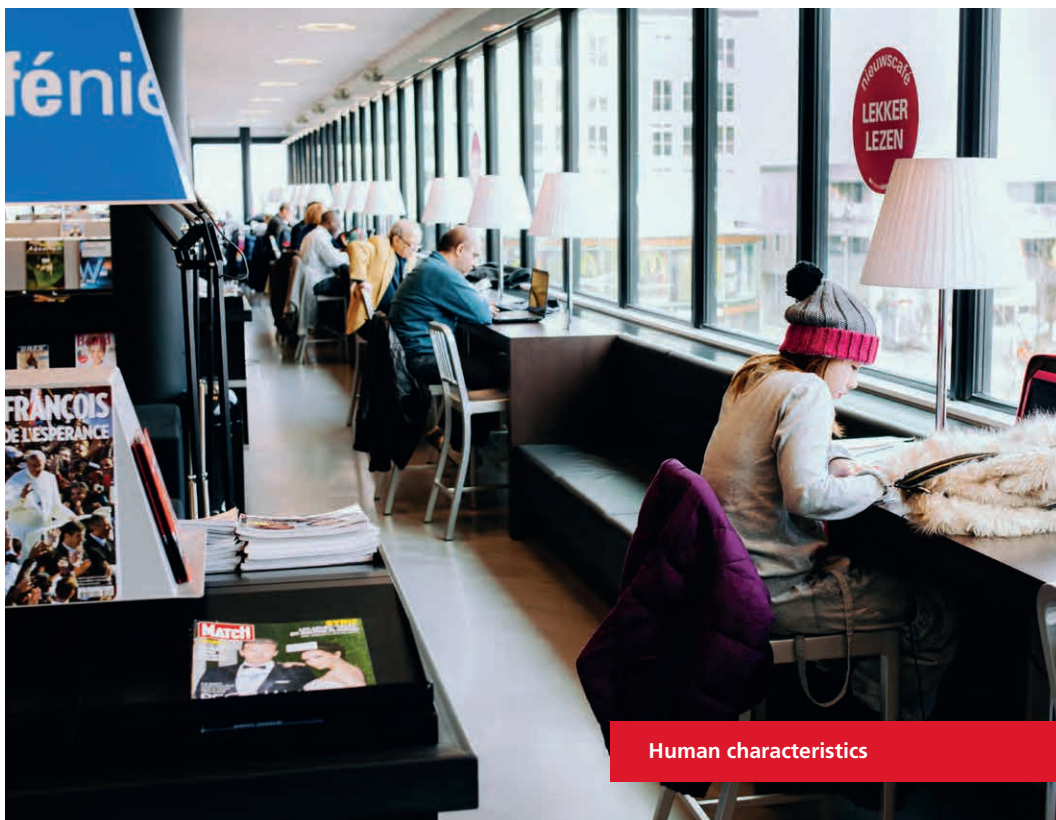
Structural fire safety engineering concerns the technical facilities that are implemented in the interest of fire safety in a building. The building is the central element. Technical facilities include the non-combustibility of materials, creating fire and smoke compartments, the locations and designs of emergency exits, automatic fire suppression systems, etc. These technical facilities can be divided into passive facilities, such as compartmentation, and active technical systems, such as a sprinkler system. Structural fire safety engineering is about how fire and building characteristics, and human and building characteristics influence each other.





### Fire safety psychonomics

Human behaviour in a building, both prior to and during a fire, is the subject of fire safety psychonomics. Here, people are the central issue. Social factors, such as group-dependent behaviour, and personal factors, such as alertness and mobility, have to be taken into consideration. Both these types of factors mainly concern people's ability to exhibit certain behaviour as well as their intentions and motives that underlie particular behaviour. The behavioural motives consist of internally driven motives that are expressed through intuitive or acquired behaviour, and of externally driven motives that are expressed through behaviour that is influenced by situational environmental aspects. These situational environmental aspects have a social and/or technical dimension. The social dimension may, for example, be group-dependent behaviour and the training and presence of in-house emergency responders. The technical dimension may, for example, concern the accessibility of escape routes. Building management plays a decisive role in the technical dimension. An example of this is good housekeeping, ensuring that all the technical and social measures and facilities in a building function properly. Fire safety psychonomics is about how fire and human characteristics, and building and human characteristics influence each other.



### *Fire intervention science*

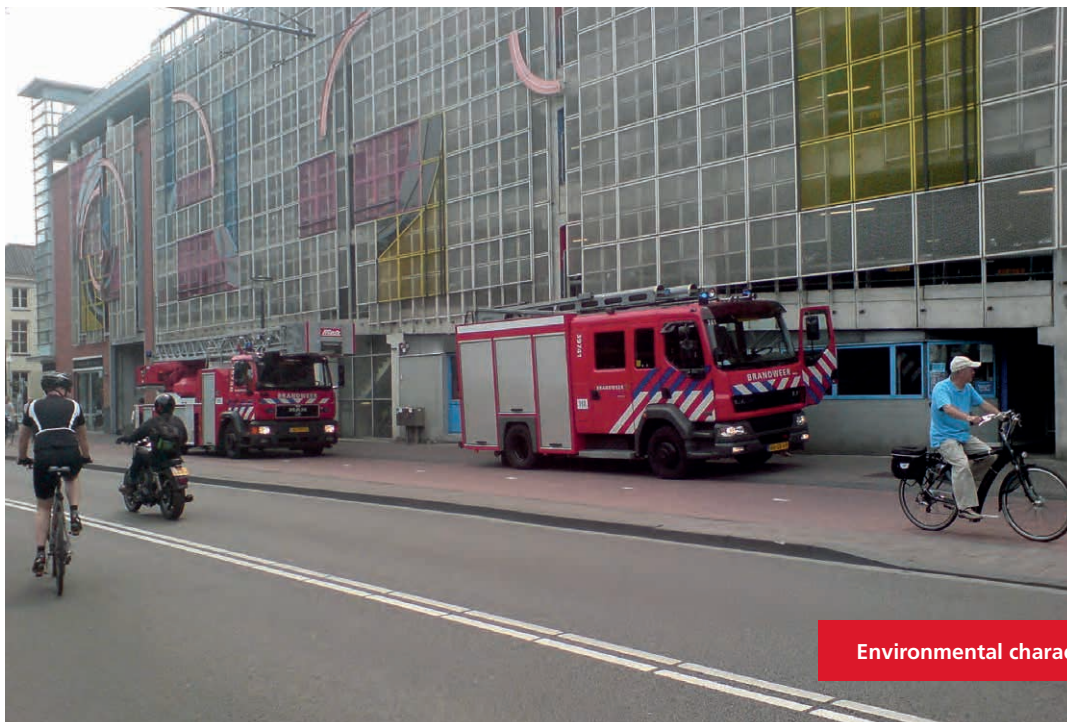
Fire intervention science looks at the response by the fire service as regards rescuing people and containing the fire, and also at the safe deployment of internal emergency responders for evacuation purposes and in order to suppress an incipient fire. This concerns both preparations for, and the implementation of, the emergency response and interagency coordination. Fire intervention science focuses on influencing the system of fire characteristics, building characteristics and human characteristics, which in turn affect the influences between characteristics.



Intervention characteristics

### Fire safety science for the surroundings

The geographic location of a building is one of the factors that determines its fire safety. The possibilities of preventing arson through social control are an example of aspects that influence this. From the point of view of intervention by the fire service, the locations of fire stations are important in this respect. Other aspects include situations where plots of land are covered by multiple storeys, e.g. underground parking garages under buildings, and the building's location with respect to risks posed by its surroundings, such as the storage and transport of hazardous materials, air traffic routes and flood areas. Fire safety science for the surroundings focuses on influencing the system of fire characteristics, building characteristics and human characteristics, which in turn affect the mutual influences of characteristics.



Environmental characteristics

## 2.2 Interactions of characteristics: an explanation

The summary of characteristics shows that the various aspects influence each other. These interactions are explained in more detail below.

### 2.2.1 The interaction between fire characteristics and building characteristics

The influence of the fire on the building is expressed in terms of:

- systems being activated
- the degree of safety or danger when fleeing from a building during a fire and during a repressive action in a building where there is a fire.

Examples are smoke spread, the danger of the building collapsing, etc.

The influence of the building on the fire is expressed in terms of:

- the fire curves and fire scenarios
- the functioning of protective facilities.

Examples are combustible or non-combustible materials, compartmentation, etc.

### 2.2.2 The interaction between human characteristics and building characteristics

The influence of people on the building is expressed in terms of:

- the risk of a fire occurring
- the maintenance and availability of protective measures, such as emergency exits, etc.

The influence of the building on people is expressed in terms of:

- the possibility of quickly discovering a fire
- the possibility of quickly fleeing from a building.

An example of this is how easy it is to find one's way through a building.

### 2.2.3 The interaction between fire characteristics and human characteristics

The influence of the fire on people is expressed in terms of:

- people having to take decisions within a very short time
- the negative effects of heat and smoke on people's powers of perception, judgement and their musculoskeletal system that determine their ability to leave a building without assistance.

The influence of people on the fire is expressed in terms of:

- their care or carelessness when carrying out activities that pose a fire hazard and that may cause a fire or may prevent the occurrence of a fire.

### 2.2.4 The interaction between intervention characteristics and fire, building and human characteristics

From the point of view of emergency response, the interaction between intervention characteristics on the one hand, and fire, building and human characteristics on the other, is initially limited. What should be considered is the interaction between the building characteristics and the safety of emergency responders in the event of repressive action, e.g. due to the risk posed by the danger of the building collapsing and fire-resistant structures failing. People's physical ability to leave the building without assistance plays a role in the interaction between intervention and human characteristics. The interaction between intervention and fire characteristics focuses on specific risks such as flashover, backdraft and fire gas explosions. This latter interaction determines the choice of the manner of repressive action by the fire service (offensive, defensive, inside, outside). Methods to enable the fire service to weigh up the fire risks and determine whether a safe attack is possible are not part of this document.

In the event of an actual attack, the emergency responders have to contend with the above characteristics mutually influencing each other. The influence of the intervention characteristics is expressed in terms of:

- the repressive action of in-house emergency responders in terms of tasks, techniques and procedures
- the repressive action of the fire service in terms of tasks, techniques and procedures
- the correlation between the actions of in-house emergency responders and a fire service.

### 2.2.5 The interaction between environmental characteristics and fire, building and human characteristics

The interactions between environmental characteristics on the one hand, and fire, building and human characteristics on the other, are mainly the result of an external hazard situation to which risks are associated. Lots of examples of this can be given. An example of a building characteristic would be that escape routes cannot be used, whereas an example of a fire characteristic would be that of a fire occurring due to a flammable liquid fire outside a building. An example of a human characteristic would be the inhaling of toxic substances from a gas cloud; an intervention characteristic could be an inability to reach a building due to obstacles or high water levels. Besides referring to it here, this document does not go into any more details about the interaction referred to in 2.2.5.

Effective interactions of characteristics in the combination of the fire hazard, the associated risks, the building, the population and the emergency response should guarantee fire safety as far as possible. Influencing fire events plays a prominent role in this and structural facilities, technical systems and organisational measures, or protection options, can provide for this.

## 3. Summary of fire events

Fire is a dynamic process in which the time element plays an important part. There is a race between fire spread and smoke spread on the one hand and discovery, evacuation, rescue and suppressing the fire on the other. During this race, events occur that determine the development of the fire. Timely intervention in the events is essential to bring the fire to a good end for all those concerned. Figure 4 provides a logical classification of the possible events and consequences of a fire that are related to intervention from the moment the fire starts up to and including after-care. The sooner an intervention is made to change the course of the events, the less significant the consequences will be. In other words: if the first event – the occurrence of fire – can be prevented, the other events are no longer relevant. If only non-combustible materials are used, fire cannot occur. This is the most effective fire prevention measure. This is an example of reducing the probability; in this case to 0%. Influencing later events, when a fire has already started, is always more difficult. In that case, a number of events of a similar nature occur alongside each other. After a fire has been discovered, the fire alarm has gone off and the fire has been reported, both the internal organisation and the fire service take action at the same time. The response to a fire by the internal organisation directly influences the fire service's action. For example: if the in-house emergency responders manage to effectively evacuate a building or a certain endangered area and put out the fire, the fire service will only have to carry out a final check afterwards. If the internal organisation does not manage to do this, the fire service's actions will focus on rescuing people and extinguishing the fire. Damping down has not been listed as an event and after-care has only been mentioned briefly. In general, the actual after-care starts once the fire is under control.

Figure 4 shows the events that are related to intervention by the in-house emergency responders on the left and the events related to the intervention by the fire service on the right. Intervention by an automatic fire suppression system that keeps a fire under control or puts it out can be found in the middle.

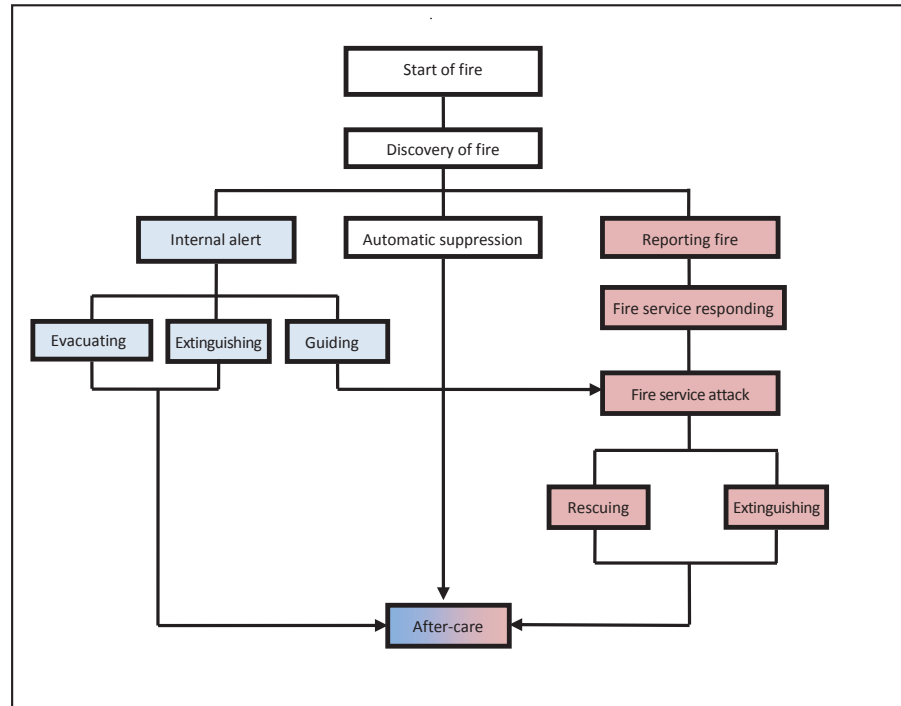


Figure 4 Fire events diagram

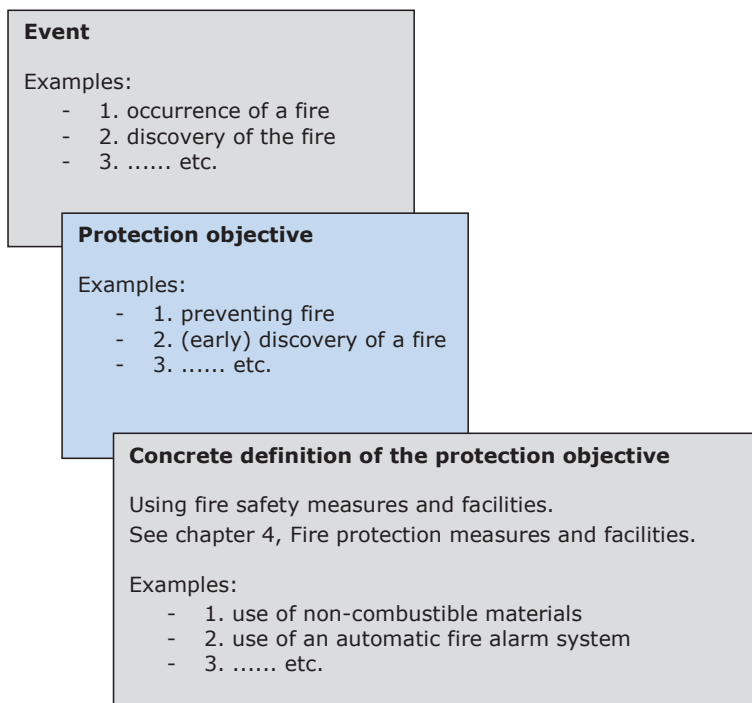
### 3.1 From event to protection objective

Since providing fire protection is about influencing the events that occur in the event of a fire, an event's protection objective has to be identified. This objective can then be used to determine which fire protection measures and/or facilities are necessary. In other words: the protection objectives are the basis for defining the concrete measures and/or facilities. This is shown in a diagram in figure 5. The protection objectives, except that of preventing fire, are correlated to evacuation and/or fleeing and intervention in the event of a fire. The protection objectives are derived from the summary of fire events. See figure 5 for the protection objectives. The protection objectives 8 to 11 form part of the fire service's intervention time.

1	Preventing fire
2	Early discovery of a fire
3	Raising the fire alarm as quickly as possible
4	Timely evacuation and/or fleeing in case of a fire
5	Action by the in-house emergency responders to suppress an incipient fire
6	Automatically suppressing a fire as quickly as possible
7	Reporting the fire to the emergency services' control room as soon as possible
8	The fire service responding as quickly as possible
9	Deploying the fire service as quickly, safely, and effectively as possible
10	The fire service saving people as quickly as possible
11	The fire service extinguishing the fire as quickly and effectively as possible
12	Providing after-care as quickly and effectively as possible

**Figure 5** Protection objectives

For further clarification, figure 6 shows a diagram of how the events are translated into protection objectives. The protection objective serves as the basis for determining the fire protection measures and/or facilities.



**Figure 6** 'From event to protection objective' diagram

### 3.2 Specifying protection objectives

When specifying the protection objectives, fire development and its division into phases play an important role. Providing protection against fire can be compared to trading in time as a fire develops.

The protection objectives in figure 5 qualify the concept of time by means of such expressions as 'as quickly as possible' and 'timely'. Although these expressions are a guide, they are not sufficiently concrete to enable the right fire protection measures and/or facilities to be determined. Subdividing fire development into phases is a first step to enable concrete protection objectives to be defined.

Fire development where the different phases have been identified implies a certain scenario specified by temperatures and time elapsing that serves as a reference to enable protection options to be chosen. The possibilities of smoke spread must be taken into account. Introducing phases with maximum times provides a more concrete reference, e.g. as regards the discovery and alerting times. Discovery of a fire and setting off the alarm must take place within x minutes of the fire starting. The fire prevention performance for discovering the fire and alerting must be delivered within the maximum times. These maximum times are general reference times but they should not be considered as target times, since the sooner protection objectives are achieved, the less significant the consequences will be.

In conjunction with a certain fire development, the phases are a benchmark for the performance to be provided by the building, the people in the building and intervention by the in-house emergency responders and/or the fire service.

The phases focus on:

- the discovery time
- the alerting time
- the evacuation time
- the reporting time for reporting to the emergency services' control room
- the fire service's intervention time that consists of:
  - a. the response time
    1. the time required to process the reporting of the fire to the control room
    2. the turnout time: the time that the fire service personnel need to man the fire appliance
    3. the driving time
  - b. the attack time
  - c. the rescue and fire extinguishing time.

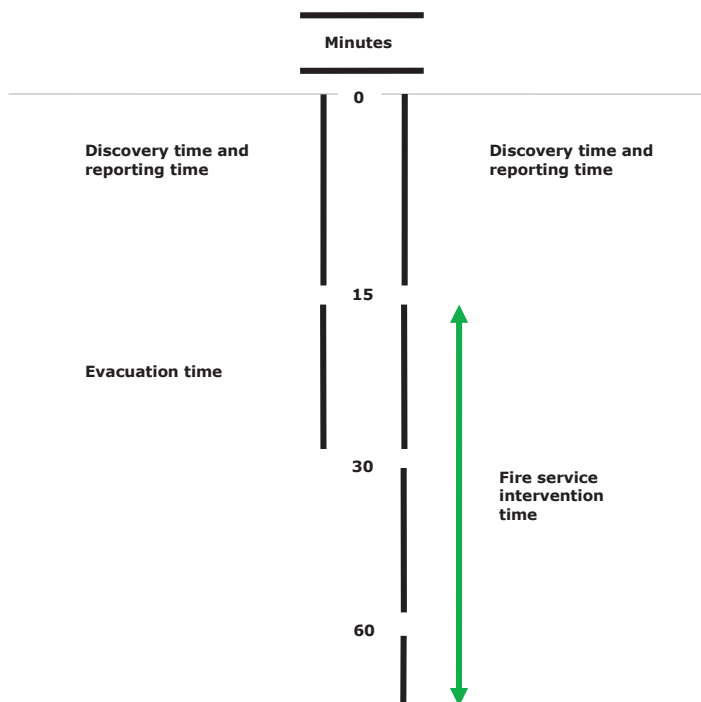
The fire service's intervention time is discussed in more detail in section 4. No further attention is paid to the damping down and after-care times here.



Figure 7 is an example of how the fire development can be divided into phases. This is correlated with the basic assumptions of the building regulations (the 2012 Dutch Building Decree - *Bouwbesluit 2012*). The example does not provide for early discovery of fire by automatic fire detection facilities. The figure shows the events that are related to intervention by the in-house emergency responders on the left and the events related to the intervention by the fire service on the right.

As a further step in the subdivision into phases, the right fire protection options can be determined by linking the development of a fire and its individual phases to the performance of an envisaged fire safety measure and/or facility and then analysing the result. This method offers an insight into the performance of the intended measures and/or facilities, enabling sensible choices to be made. The link and analysis have been implemented in a manner comparable to the former Dutch fire protection concepts (see also chapter 4).

The results of the link and analysis are areas that require special attention when defining common fire safety measures and facilities in buildings. They denote an integrated approach to fire protection that matches the basic assumptions of the prevailing regulations, making this a rule-based integrated approach. When opting for a risk-based approach, the areas that require special attention serve as a frame of reference (see chapter 3).



Note:

The times stated are maximum times and should not be considered as target times. The rule is always: the shorter the time, the better this will be for fire safety.

The phases that are related to intervention by the in-house emergency responders are stated on the left. The phase relating to intervention by the fire service is shown on the right-hand side.

**Figure 7** Fire development phases

#### 4. Fire service intervention time

It would be wrong to link the response times, as part of the fire service's intervention time, to the possibility of achieving a successful prevention result. Such a strategy cannot be substantiated. Linking the response time to the prevention result suggests a certainty that does not actually exist in the real world. This is due to the many uncertain factors that play a role in a fire and in the intervention in the event of a fire. Looking at it this way, from the point of view of prevention, it would be incorrect to take a repressive action and therefore the success of repression for granted in advance.

The fire service's intervention time starts once the fire has been reported to the central control room of the emergency services. The effect of such intervention depends on the moment when it is implemented, on the speed at which the fire develops and the extent to which the smoke spreads. The degree to which the fire service is capable of implementing a successful intervention depends on the intervention possibilities, the attack tactics and techniques at the fire service's disposal. Time is an important factor in the intervention. The relationship between the time and the consequences for victims and damage or loss depends on the situation and is not necessarily a linear relationship. The intervention time is determined by the response time, the attack time and the rescue and fire extinguishing times. Damping down and after-care times can also play a role. See figure 8 for a schematic view of the intervention time.

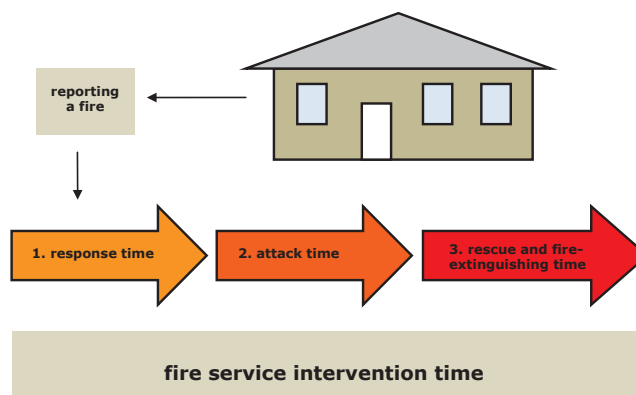


Figure 8 Time diagram

1. The response time is the time that elapses between the moment when the fire is reported to the control room and the moment when the fire service has reached the scene of the fire. This time is determined by:
  - the time required to process the report of the fire at the emergency services' central control room
  - the turnout time: the time the fire service needs to man the fire appliance
  - the driving time.
2. The attack time is the time that elapses between the moment when the fire service arrives at the scene of the fire and the moment when fire service personnel take operational action.
3. The time required for rescue and for extinguishing the fire is the time that elapses between the moment when the fire service has taken operational action and when the fire is under control.

The damping down time is the time that elapses between the fire being under control and the damping down of the remnants of the fire; after-care time is the time that elapses between the moment after-care provision has actually started and the moment it ends.

### Consideration of the times

The intervention by the fire service, expressed in time, is determined by the sum of the times 1 - 3.

#### Response time

The current Dutch Safety Regions Decree (*Besluit veiligheidsregio's*) states standard response times for setting up basic fire service care. The original objective of response times was to be able to determine the optimum distribution of fire stations. This has now been provided for by defining standard times for incident response times. The governing body of the safety region has the authority to adopt other times. Costs, benefits and the region's risk profile play a role in this (see chapter 6). Furthermore, the response times are subject to normal traffic disruptions which may lead to later deployment.

#### Attack time

The attack time depends on the situation and is closely related to the accessibility, size and purpose of a building. For example, the attack time for a prison is longer than that for the average office building, and it will be shorter for a single-family home on its own plot than for a flat on the tenth storey of a residential building.

#### Rescue and fire-extinguishing times

The rescue and fire-extinguishing times depend on the situation and are closely related to the prevailing circumstances in the event of a fire. For example: a fire in a building that spreads fast and where there is a lot of smoke will require a greater effort to rescue people and lead to a longer rescue and fire-extinguishing time than would be the case for a minor fire with little smoke.

## 5. Context of the fire prevention

Absolute safety cannot be assured and we should not pretend that it can. Safety risks must be minimised as far as is reasonably feasible. Architectural and technical facilities may make an important contribution to this, but technology is not infallible. Personnel and organisational measures are crucial when it comes to the use of buildings. This mainly applies to buildings from which people cannot flee without the assistance of third parties, e.g. healthcare buildings, including nursing homes, and buildings that house cells. It is important that, in these buildings, attention is paid to the balance between restrictions affecting physical safety and the degree to which this is compensated by internal organisation measures, since human action will always be a vulnerable element. Safety basically depends on people's actions and people are not infallible either. It is inevitable that

there will always be a residual risk. There is no 'zero risk society'. In other words: society as a whole should attempt to prevent calamities and should be aware that, nevertheless, calamities can always occur. It is not possible to give a 100% guarantee that no one will fall victim to a fire. However, effective fire safety measures and facilities, combined with good assistance, can greatly reduce this risk.

Fire safety is essential, but it is not the only element of the wider term 'safety'. Fire safety must be implemented as effectively as possible, without affecting other forms or aspects of safety. Some buildings involve special responsibilities, such as buildings that house cells. Here, the special responsibility is the safety and security of the society, the safety of people entrusted to the care of the government, and the safety of the people working in the institution in question. This safety and security involves both interests that reinforce each other and mutually conflicting interests. All risks, such as the risks of inmates breaking out of prison, disorder, violence among inmates and against prison guards as well as the risks that occur in the event of a fire, must be minimised. The consequences and cost of fire protection measures and facilities have to be compared to and weighed against those of other safety aspects. Other examples of buildings are bank buildings and courthouses. Security facilities in buildings may also conflict with fire safety.

Fire safety continues to require attention during the management phase. This specifically applies to the building's use, including the maintenance of fire protection facilities and the effective action of in-house emergency responders. Fire safety demands continuous attention in order to achieve the right 'awareness' among the people involved as part of fire safety management in a building or institution. Please remember that fire safety is never finished.

Architecture plays an important role in designers' perception. They see architecture as the science of designing and constructing buildings. Producing buildings from drawings, calculations and a design for the actual building is a science and a skill. In addition to technical aspects, there are also artistic, social, economic and philosophical aspects to designing. For designers, buildings are a representation of ideas about the envisaged use and about relationships in society. The perception of the government, which audits compliance with standards and regulations, is different from this. The government thinks in terms of fire-resistant partitioning structures, evacuation and fire propagation. Buildings are not made with fire safety in mind: they serve a certain purpose and a certain function. Of course, buildings must be adequately protected against fire. The tensions between the design of a building and the implementation of fire safety facilities can be logically explained given the different backgrounds of the designer and auditor. Trying to change this would mean attempting to change reality.

## 6. Fire safety balance

Given the phased fire development, the degree of fire safety in a building is determined by the combination of building characteristics, human characteristics, intervention characteristics and environmental characteristics. This combination can be compared to balancing a pair of scales. See figure 9 for the fire safety balance.

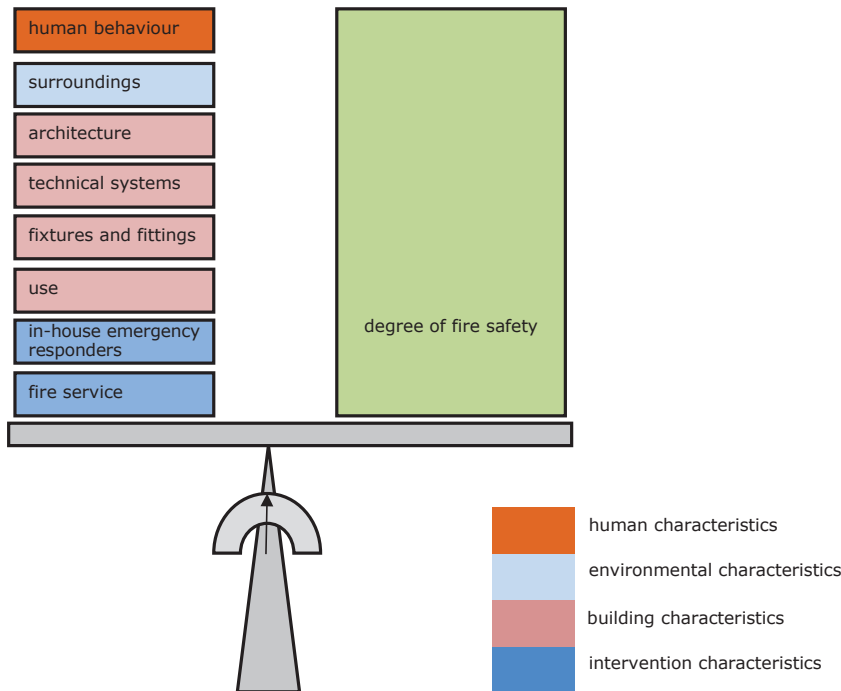


Figure 9 Fire safety balance

Fire protection measures and/or facilities that are part of the system of characteristics can be mutually exchanged provided that the balance is not disturbed and the main objectives and the protection objectives of fire prevention are met. Subjects that require a careful assessment in this respect are the fleeing/evacuation times, fire/smoke spread and intervention (see chapter 4).

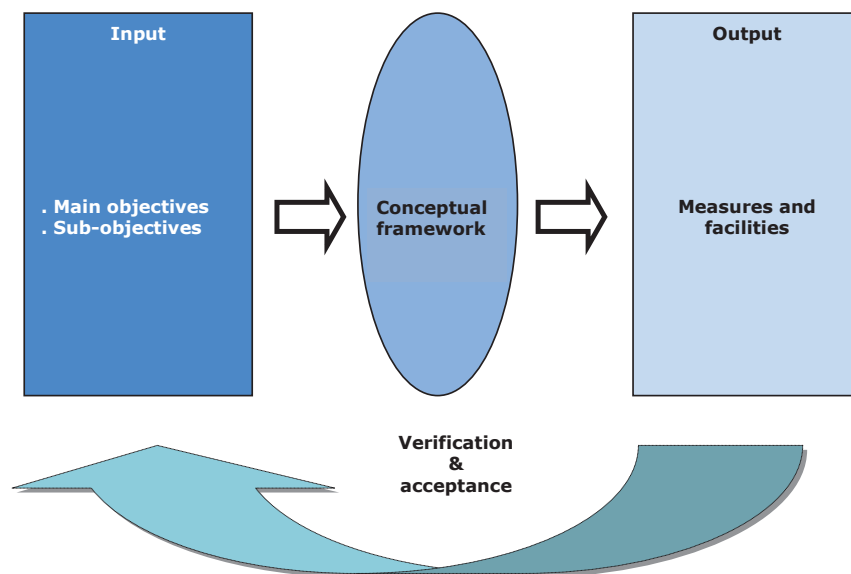
## 7. Method using the conceptual framework

The conceptual framework is a tool that enables the main and sub-objectives to be translated clearly and transparently into concrete fire protection measures and facilities.

As many factors play a role in choosing fire protection measures and facilities, it is quite easy to make the wrong choices. To prevent this, it is important that the choices, the output of the conceptual framework, be verified against the input of the model. The same is true for both the main and sub-objectives.

If the protection options chosen enable the protection objectives to be achieved, the verification is positive and the only question is whether the residual risk is acceptable. If it is acceptable, implementation can be started.

If the verification and/or the acceptance is/are negative, this implies that the wrong choices have been made in the conceptual framework. In that event, another type of protection option must be chosen which does lead to a positive result. A verification and acceptance diagram is shown in figure 10.



**Figure 10** Diagram of verification and acceptance combined with the conceptual framework



## **Chapter 2**

# **Fire prevention: from rule-based to risk-based**







## Introduction

Chapter 2 describes the route from a rule-based approach to fire prevention to a risk-based approach. The explanation is closely related to the Fire Safety Action Programme (April 2009) of the Dutch government which, among other things, contained the statement that insufficient attention is paid to safety when designing and using buildings: the 'only' effort in this respect is usually the application of rules, without being aware of the background, reasoning and possible consequences. A risk approach requires all parties involved, including the owner of the building, the designer and users, to think about the way in which fire safety is achieved and assured. Scenarios and models, including fire models, play an important role in a risk approach. Having an understanding of fire growth, based on models, is important from a preventative as well as from a repressive perspective. This chapter mainly deals with the preventative angle. New fire modelling developments are briefly discussed by means of an explanation of the cascade model.

The Dutch Building Decree, the epitome of a rule-based document, has been used as a reference for the development towards a risk-based approach. Section 1 describes a theoretical fire development, including the relevant phases, based on the general assumptions of the Dutch Building Decree. This fire development is an important reference for the performance rules in the Dutch Building Decree. As a next step, this approach is analysed and compared to the model-based approach to fire prevention from chapter 1. Section 2 deals with the change in thinking from a rule-based approach to a risk-based approach and contains an explanation of the application of the risk-based approach. Section 3 is an introduction to the risk-based approach to fire prevention using natural fire curves, also called 'natural fire design'. Section 4 addresses the result of recent studies of fire models: the cascade model.

### 1. Rule-based fire prevention

When implementing fire safety for buildings in practice, the Dutch Building Decree is the most dominant document due to its direct bearing on building and rebuilding. Uniform rules and equality before the law for private citizens are some of the key terms of the Dutch Building Decree. The Dutch Building Decree is a detailed scheme with a great many performance rules. These rules represent a level of fire safety for buildings classified into new build, alteration or renovation, temporary buildings and existing buildings. The highest level of facilities required is applied to new build, whereas

the lowest permissible level is applied to existing buildings. The level of the fire safety rules is not based on any recognisable risk analysis. A rough assessment is used and this is expressed in the performance levels of the different types of buildings. The level contained in the rules is mainly based on history, acquired rights, feasibility, experiences and agreements between parties as to threshold values. There is little scientific substantiation (see chapter 7).

The Dutch Building Decree is a rule-based document intended to prevent casualties and to prevent a fire from spreading to another plot. Its general assumptions are as follows:

- A fire must be discovered and the people endangered by it, as well as the fire service, must be alerted within 15 minutes of the fire starting.
- The people endangered by a fire must be able to flee without the fire service's assistance within 15 minutes of having been alerted.
- The fire service is present and operational within 15 minutes of the fire being reported.
- The fire service must have the fire under control within 60 minutes of the fire starting, which implies that the fire must be prevented from spreading further. At such time, the last people endangered by the fire must have been rescued with the fire service's assistance.

See chapter 6 for further information about building regulations.

The Dutch Building Decree is divided into various sections that provide instructions on such matters as:

- the strength of building structures in the event of a fire
- restricting the occurrence of a fire hazardous situation
- restricting fire growth and smoke development
- restricting fire spread (fire compartmentation)
- further restricting fire and restricting the spread of smoke (sub-fire compartmentation and smoke compartmentation)
- escape routes
- the emergency response in the event of fire
- high and underground buildings
- systems that enable fire to be detected in good time
- systems for fleeing in the event of a fire
- fire suppression systems
- systems and facilities that optimise accessibility for emergency services
- fire-safe use.

Threshold values and determination methods govern the level of the rules. The Dutch Building Decree contains an equivalence provision that states that the rules do not have to be complied with if the same level of fire safety is achieved and maintained as is envisaged by the rules.

## 1.1 Equivalence

The possible applications of the principle of equivalence have evolved over the years. Its application was limited when the Dutch Building Decree took effect in 1992. Equivalence was then considered as equivalence with one performance requirement and the equivalent solution had to be found in architectural means and/or by installing the relevant systems. Later, the equivalent solution was also allowed to comply with the functional requirement. The arrival of the Dutch Building Decree of 2012 has offered even more distinct scope for the equivalent solution. What matters is the combination of the rules and their interchangeability with organisational measures.

Being able to make an assessment in the context of equivalent fire safety requires knowledge of statutory schemes and of the backgrounds of the applicable performance requirements. The objectives envisaged by the legislator, as well as the legislator's basic assumptions, should form part of such knowledge. An equivalent solution that differs from rules from the Dutch Building Decree may be implemented. It must be noted in this context that functional requirements provide a substantiation of the rules. In a certain sense, they are sub-objectives of the government's objectives, and not the government's actual objectives, representing their fundamental importance for society. A functional requirement may give a good indication where part of a section of the Dutch Building Decree is concerned, but not where an integrated approach is concerned. Therefore, the functional requirements cannot and do not have to form the basis on which equivalence must be assessed. In other words: functional requirements may be deviated from. Furthermore, functional requirements may depend on other functional requirements for their operation. For example: if extra measures are taken to restrict fire growth and the development of smoke, this will affect escape safety. This means that an equivalent solution goes beyond the functional requirement contained in a section of the Dutch Building Decree.

The equivalent solution concerns an assessment on the basis of the combination of rules. It is sufficient if this combination achieves the level envisaged. It is possible that, in a specific case, the level envisaged is achieved if one or several performance requirements are not applied. In fact, an integrated assessment of fire safety is to be applied. Interaction and exchange between and of architectural and structural facilities, technical systems and organisational protection options is possible for solutions. A certain reserve must be applied for example when compensating architectural and structural facilities by organisational measures. People's behaviour in the event of fire is volatile. In the past, a certain reserve was also applied to the use of technical systems as equivalent solutions for architectural and structural facilities due to the suspected risks of such systems failing. However, it has been found in practice that the risk of technical systems failing is no greater than the risk of architectural and structural facilities failing. Proper maintenance is crucial in both cases.

As regards the equivalence provision, it must be noted that if one solution is applied to achieve equivalence this may lead to different levels of safety in different buildings. An equivalent solution is a bespoke solution, specific for a specific building. By definition, the solution cannot be applied generically to all buildings.

## 1.2 Fire development as a basic assumption

The actual fire is the central element when considering how to protect buildings against fire. Fire can be a hazard and thus involves risks. What kind of fire can be expected, how fast will it grow and how much heat and smoke will develop? Since fire is a dynamic process in which the time element plays an important part, a certain fire development should be taken into consideration in advance when protecting buildings from fire. This fire development should be 'translated' into adequate protection options.

The general assumptions of the Dutch Building Decree are based on a certain time elapsing during a fire: the maximum times. These are divided into phases, such as a phase for the time to discover the fire and a phase for the evacuation time. These phases have a certain time sequence and are interrelated. They indicate the number of minutes fire safety measures and facilities should last or take to operate properly. For example, the performance rules of the Dutch Building Decree 2012 require a 30-minute threshold value for fire resistance for fire compartmentation.

To be able to determine the resistance against fire of building structures or parts of structures, a standardised fire development, i.e. the standard fire curve, is used. The standard fire curve has been standardised and laid down in NEN 6069. See Figure 11. The standard fire curve is a graphic representation of the temperature development of a fully developed fire over time. The fire curve describes the phase of the flashover and the period that follows. The model assumes an exponential increase in temperature up to a certain maximum. The model then assumes that the temperature remains at that maximum temperature, without changing, for a certain period, e.g. 60 minutes. The standard fire curve is necessary from the point of view of uniform testing to enable qualification and comparisons between different building structures or parts of buildings. An example of a performance requirement is that a certain wall structure of a fire compartment must resist fire for at least 60 minutes. The resistance is determined by the temperature/time development of the 'standard' fire curve and is documented in a report, e.g. a test report by Efectis.

The quotation marks modifying the 'standard' fire curve serve to indicate how relative the word 'standard' is in practice. A fire is never standard in a real life situation. When compared to real life, the standard curve is simply a theoretical reference model. In practice, few fires are the same. The fire development depends on a wide range of circumstances and it would be a mere coincidence if the temperature/time development of an actual fire was exactly the same as that of the standard fire curve. This also indicates

how relative a requirement like a 60-minute fire compartment is. In fact, all it means is that a sample of the wall has been proven to be fire resistant for 60 minutes when tested in a standardised fire in a laboratory. The effect on the wall of a real fire in a real-world fire compartment will be different, leading to different fire resistance in practice. However, if there is sufficient combustible material in a room, the temperature/time development of a fully developed fire will often display similarities to the development of the standard fire curve. This does not apply to the first growth phase of a fire. From the perspective of the general assumptions of the Dutch Building Decree, this phase is an extra safety margin, in keeping with the period of the first growth phase. You can find more information about other kinds of fire curves in section 3.1 of this chapter.

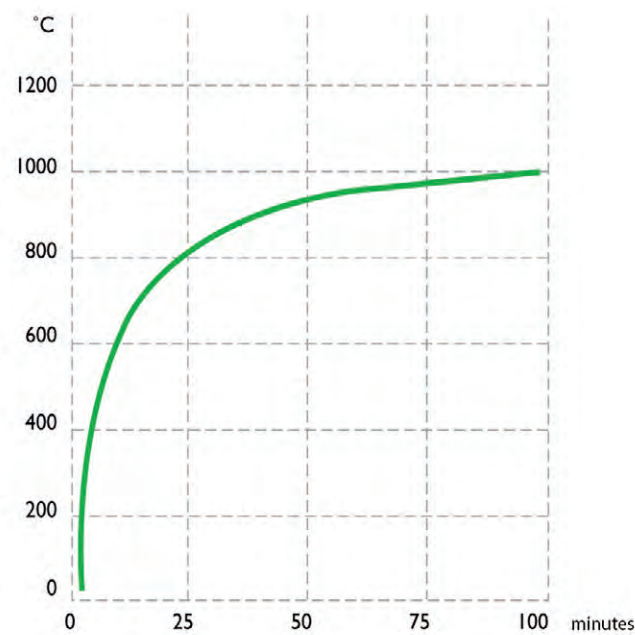


Figure 11 Standard fire curve

Note:

The resistance to fire, expressed in minutes, is directly related to a building's fire load. The fire load is in turn directly related to the burn time. A fire load of 60 kg of pine wood per m<sup>2</sup> has a burn time of approximately 60 minutes (1 kg of pine wood/m<sup>2</sup> ≈ 1 minute).

The maximum threshold values in the Dutch Building Decree are 60 minutes for the fire resistance of structures, with the exception of the threshold values for the structural safety of buildings (fire resistance as regards building structures collapsing). The sum of the permanent and variable fire loads has been taken into account when determining this threshold value. In other words: the Dutch Building Decree implicitly takes average values of fire loads of and in buildings into account. The threshold values are based on average values. The variable fire load has been taken into account in this. As a further clarification, figure 12 shows the conversion factors for kg of wood, MJ and kWh.

From/To	kg of wood	MJ	kWh
kg of wood	1.0	19.0	5.278
MJ	0.0526	1.0	0.278
kWh	0.2053	3.6	1.0

Figure 12 Conversion factors for kg of wood, MJ and kWh

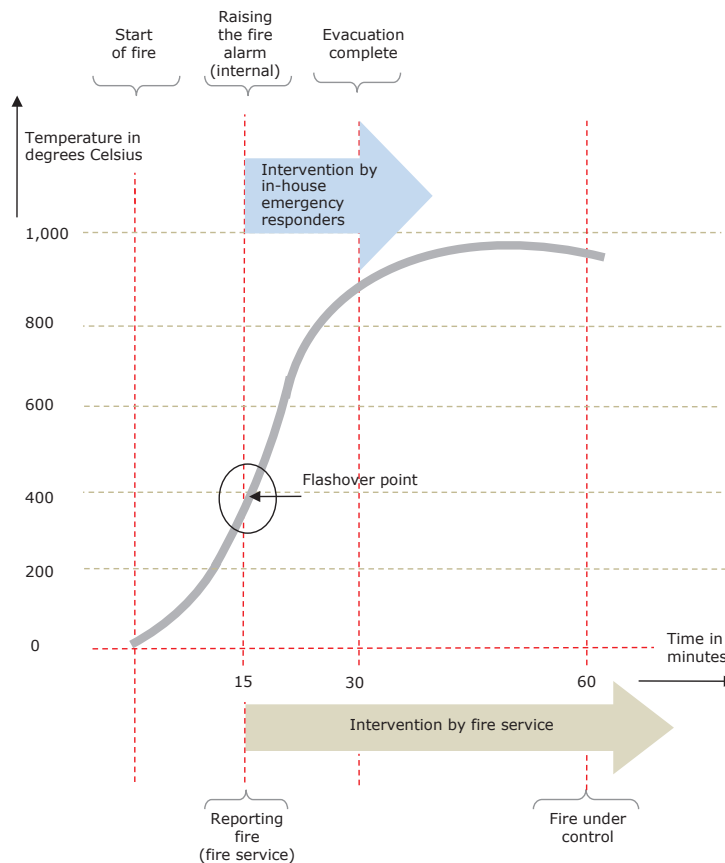
### 1.3 Normative fire development

The former series of Dutch fire protection concepts for buildings defined a normative temperature/time development model based on the correlation between actual fires and tests, compared to the standard fire curve.

Application of a temperature/time development that displays many similarities with the standard fire curve is justifiable. This is because, in general, the layout of buildings and the variables and permanent fire load in the event of fire that can be expected in them lead to a fire development that displays many similarities to the standard fire curve. A 'fully developed fire' is then possible.

The normative fire development is related to the general assumptions of the Dutch Building Decree. It is a reference that sets a norm and enables the fire safety of buildings to be implemented using a rule-based approach. The temperature development of the normative fire development, shown in figure 13, is not proportional to the time that elapses. After a - usually - slow development in the beginning, where the temperature in the room gradually increases, the fire suddenly develops very quickly and the temperature in the room also increases very quickly (flashover point). Beware that real-world situations may also occur where a fire grows very quickly from the beginning, due to fire hazardous material and/or due to the choice of product, causing the moment of flashover to be reached sooner.

The use of the normative fire development has been found to be an effective and convenient method for a rule-based approach to the fire safety of buildings, except for the sector of industrial buildings. The different fire development phases can vary in different types of buildings, due for example to the operation of an automatic fire alarm system with full monitoring in buildings where people need the assistance of others to be able to leave the building (e.g. a nursing home), compared to buildings where this does not apply (e.g. an office building). Shorter discovery and alerting times can be expected when there is an automatic fire alarm system with full monitoring.



**Figure 13** Current normative fire development – example with division into phases

When applying normative fire development to the sector of industrial buildings it should be noted that the fire load in certain industrial buildings, and sometimes also in other buildings, substantially exceeds the fire load taken into account in the Dutch Building Decree. This may cause shortcomings in fire control, as may be the case in storage buildings with a high variable fire load, e.g. 180 kg of pine wood per m<sup>2</sup>. Assuming that 1 kg of pine wood per m<sup>2</sup> equals a burn time of approximately 1 minute, this equals a burn time of some 180 minutes. The fire resistance requirement of the Dutch Building Decree is in shrill contrast with this, as it is substantially less, i.e. a maximum of 60 minutes. As long as the compartment size matches the threshold values provided by the Dutch Building Decree there is no problem from a rules point of view. Where fire compartments exceed the threshold values, the fire load can be taken into account. In the context of equivalent fire safety, the Controllability of Fire method (see section 1 of chapter 4) can be used for this.

Note:

The Controllability of Fire method suggests equivalent solutions for large fire compartments, i.e. areas exceeding the threshold values of the Dutch Building Decree. Suggestions for solutions that require a predefined result of the repressive fire service from a preventative point of view lead to uncertain fire safety and should be avoided (see also chapter 6).



## 1.4 Translating the normative fire development into protection options

Linking the normative fire development and the phases differentiated within it to the performance of an envisaged fire safety measure or facility and then analysing this link helps to shed light on how the measure and/or facility functions. This link and analysis have been elaborated further in chapter 4 in a comparable manner to that used in the former series of fire protection concepts.

Reference is made to the following types or parts of buildings:

- Building group 1: able to leave without assistance, non-residential
- Building group 2: able to leave without assistance, sleeping, non-residential
- Building group 3: not able to leave without assistance, sleeping, non-residential
- Building group 4: able to leave without assistance, residential buildings and homes.

The link and analysis result in a list of areas that require special attention for suitable and commonly used fire protection measures and facilities. This list can be used as an integrated reference framework for the fire protection of buildings.

## 1.5 Comparison of rule-based fire prevention with the conceptual framework

Comparing the current rule-based approach to fire prevention with the model-based approach from chapter 1 yields information as to whether a risk-based approach could be used as part of the current set of rules. The comparison is based on expertise and experience.



People who can leave without assistance





People who can leave without assistance; sleeping



Residents who can leave without assistance



People who cannot leave without assistance; sleeping

## Comparison

The key document for the rule-based approach is the Dutch Building Decree from 2012, since this decree contains many performance rules. The Dutch Building Decree is prescriptive: it is a normative set of regulations that contains threshold values, which is desirable and to be applauded from the point of view of legal assurance. The Dutch Building Decree promotes clarity by providing performance rules that match the scope of the functional regulations. This is mainly appropriate for simple, low-risk buildings that match the threshold values of the regulations.

The set of regulations does not go far enough for buildings considered to be complex or high-risk, and for buildings that do not match the threshold values provided in the regulations. Equivalent fire safety then comes into play. When implementing fire safety in practice, it transpired that assessing fire safety on the basis of equivalence had been insufficiently developed. This is due to various factors, including poor knowledge of the objectives and basic assumptions of the fire safety rules. Applying the rules of the Dutch Building Decree often seems to be the goal, rather than using the rules as a means to achieving an effective fire safety level. Users of the Dutch Building Decree often apply the building rules without considering other aspects of fire safety. The rules then constrain and isolate users, as a result of which they fail to pay sufficient attention to the necessary integrated approach based on building, using, and providing emergency assistance. In many events, this method negatively affects the quality of the necessary prevention result. Creative equivalent solutions do not seem to be possible.

This method is partly a reaction to past fires with fatal casualties, such as the pub fire in Volendam (2001) and the fire in the Schiphol cell complex (2005), which led to a knee-jerk reaction among those responsible for granting permits, who have become increasingly nervous of deviating from the rules. Their action is defensive and shows a tendency to strive for 100% safety. Creativity and a solutions-oriented approach hardly come into play at all and they are reluctant to give a positive response to equivalent solutions. The fear of being held accountable for allowing deviations from regulations is often prominently present. 'Better safe than sorry' seems to be their motto.

The Dutch Building Decree is:

- a set of regulations based on a traditional, architectural approach due to passive fire protection options, as a result of which active fire protection options are paid little or no attention
- an object-oriented system with a relatively crude indication of functions and building purposes (little or no focus on risks or people)
- barely equipped to define equivalent, integrated fire safety solutions and so it frustrates bespoke solutions

- a document that is applied in terms of sectors, with insufficient attention being paid to the synergy of building/rebuilding and buildings' later use, e.g. organising an in-house emergency response team.
- aimed at restricting the spread of fire and not at preventing fire.

The conceptual framework from chapter 1, which consists of a combination of fire characteristics, building characteristics, human characteristics, intervention characteristics and environmental characteristics, provides a summary of the different interrelationships that are at play in the event of a fire. Some of the conclusions that can be drawn from comparing this combination to the set of fire safety rules of the Dutch Building Decree are that the Dutch Building Decree:

- does not consider fire characteristics and the risks associated with them
- hardly considers human characteristics, except the qualification of whether people are bedridden, as in a nursing home for example, or are confined, as would be the case in a prison. People's behaviour does not play a material role in the Decree.

Comparing the Dutch Building Decree as an instrument to the conceptual framework shows that the rule-based approach of the Dutch Building Decree is not a good match with the conceptual framework. In other words: the Dutch Building Decree is not well suited to a risk-based approach according to the conceptual framework. Compared to the conceptual framework, the rules of the Dutch Building Decree come with many limitations. It is an unrefined system with little nuance. But this does not imply that the Dutch Building Decree should be disregarded, since the majority of buildings are not high-risk and are not complex. A system of regulations as contained in the Dutch Building Decree is and will remain a suitable instrument for this category.

The Fire Safety Action Programme, drawn up by the Dutch government in response to the fire in the Schiphol cell complex, also questions the existing regulations. The programme includes a vision of fire safety. The summary formulated in that vision is as follows:

“In summary, it may be concluded that, from a technical point of view and as regards their contents, the current regulations in themselves suffice to ensure fire safety, but that, time and again, application of these regulations has been found to fail to lead to sufficient assurance of fire safety. The Action Programme identifies this dilemma by noting “that the current system of fire prevention has reached the limits of its possibilities”. The problems as regards fire safety are mainly the result of how the rules are dealt with. All parties agree that an improvement of fire safety should be sought in increasing safety awareness, further exploration and further application of a more integrated approach to risks and an unambiguous distribution of responsibilities, and no longer in rules and stricter enforcement. This vision of fire safety is the starting point for analysing bottlenecks in the current system and the basis for possible solutions. The current system can be reviewed, and adjusted and revised where necessary, on this basis.”

This vision of fire safety contains the course to be taken in the next few years, providing guidelines for any changes to the system of fire safety. The vision features a risk approach to fire safety when designing and managing buildings. To quote from the vision: “The design of a building must be considered more coherently, taking fire safety into consideration: which risks are there, which measures can be taken in view of them, what are the residual risks and how can they be minimised. Contrary to the current approach, where there are generic rules related to the use of a building, the new risk approach should lead to a restriction of the specific risks inherent in a certain building. Etc.”

## 2. From rule-based to risk-based

Changing from rule-based fire prevention to risk-based fire prevention requires a philosophy that differs from the current philosophy that is common in practice. The principle of this philosophy is explained further in this section, by means of four figures. In these figures, which are all based on the same coordinate system, the vertical axis shows the consequences/effects and the horizontal axis shows the probabilities. Examples are given between the figures that serve as a further explanation.

Figure 14 shows a protection approach based on rules with threshold values. An example of this is a system with performance rules, e.g. the Dutch Building Decree. The effect line/threshold value demarcates a strict separation between those areas in which rules apply (area with a red arrow) and in which no rules apply (area with a green arrow). The strict separation indicates the border between right and wrong, or safe and unsafe. Probabilities are not taken into consideration.

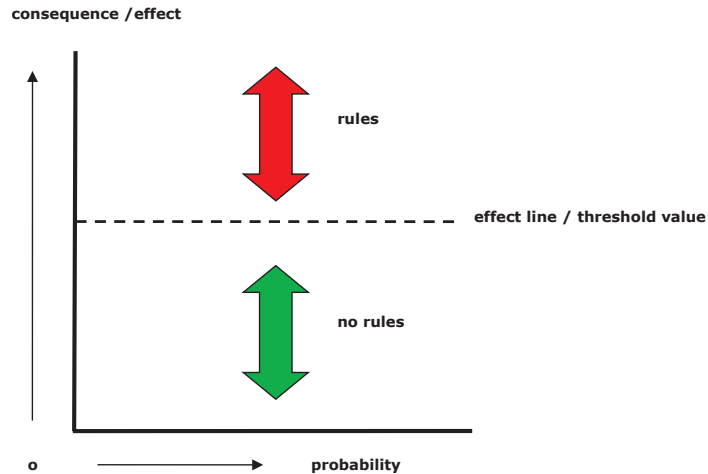


Figure 14 Protection approach with rules

Figure 15 shows a protection approach based on risks. The horizontal effect line has been changed to a diagonal risk line. Such an approach is, for example, applied to the sector of external safety. Such a risk approach involves a shift in those areas in which rules apply (area with a red arrow) and those areas in which no rules apply (area with a green arrow). The relationship between the probabilities and the consequences/effects determines whether certain rules apply, based on a gradually sliding scale. Risks are a question of probability and effect. The following applies:

- The combination of low probability and a slight consequence is negligible. No measures and/or facilities are necessary.
- The combination of low probability and a major consequence is not negligible. Consideration should be given to whether the risk is acceptable when measures and/or facilities are applied.
- The combination of high probability and a slight consequence is inconvenient. This can often be solved quite easily.
- The combination of high probability and a major consequence is unacceptable. Measures and/or facilities are necessary in this case.

Further information can be found in chapter 5, Risks in the event of a fire.

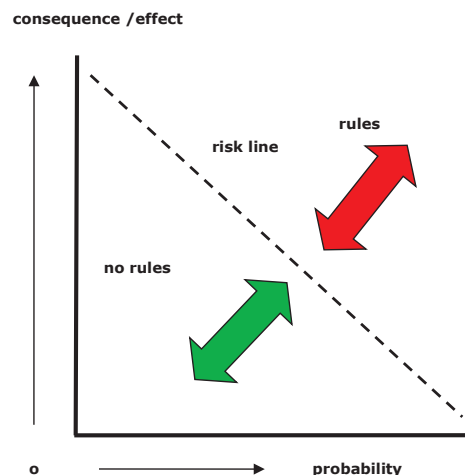
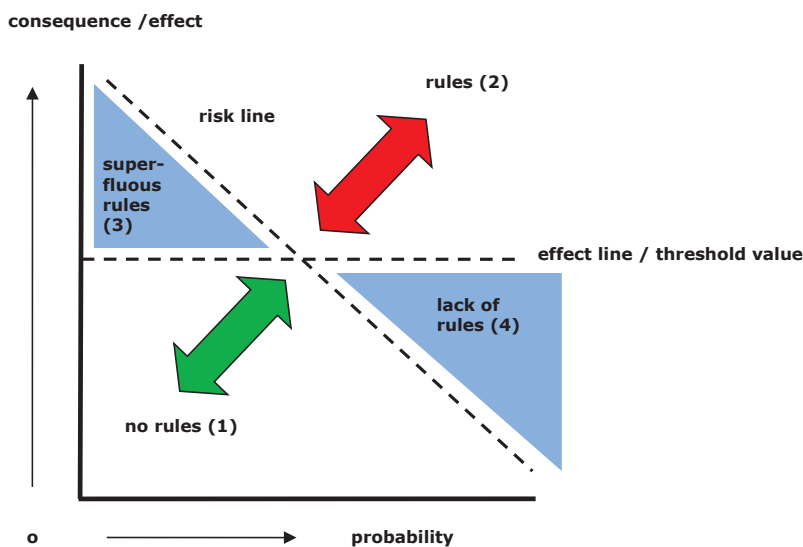


Figure 15 Protection approach with risks

Figure 16 shows a comparison between the rule-based protection approach and the risk approach. The prior two figures have been merged for this. The figure shows that, from a risk approach perspective, there are two areas that can be commented on. They are the area with superfluous rules (3) and the area with a lack of rules (4). This is illustrated by an example.

**Example:**

On the basis of the Dutch Building Decree certain buildings must be provided with one or more fire hose reels if a threshold value of the occupancy surface is exceeded. Users of the buildings use these fire hoses to put out an incipient fire. The correlation between surface dimensions and fire is strange. The risk of fire is what matters. If there is low probability and a slight consequence, the risk is negligible. This is the case, for example, if there is no combustible material present. The rule requiring the presence of fire hose reels is a redundant and disproportionate rule in this case. Vice versa: if the probability and the consequences are more significant, a situation that justifies the necessity of one or more fire hose reels may occur, whereas, according to the rules, based on the criterion of the occupancy surface, fire hose reels may not be necessary. Looking at the risk, there may be a lack of rules in such situation.



**Figure 16** The different protection approaches compared (rules and risks)

Figure 17 qualifies the risk line. This figure is based on the previous figure. What matters here is the area around the risk line. Starting from the perspective that minor probabilities with major consequences are not negligible, a risk assessment must be made to determine whether acceptance is possible. The consideration requires expertise. When making this consideration, the freedom to decide is not only restricted to a risk line, but concerns an area around this line, the dotted ellipse.

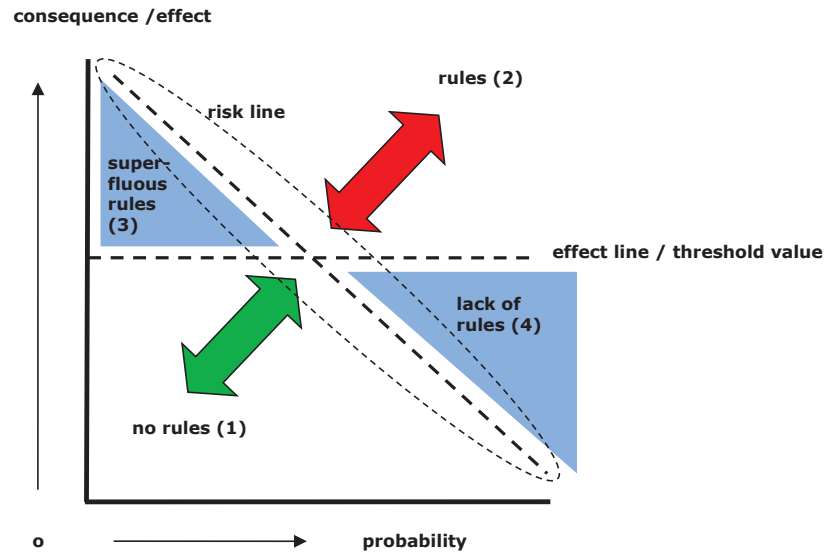


Figure 17 The different protection approaches compared (rules and risks)

## 2.1 Consideration

The hard effect lines, the threshold values, play a central role in rule-based fire protection, such as that defined in the Dutch Building Decree. They determine a strict separation between right, i.e. complying with the threshold value, and wrong, i.e. a failure to comply with the threshold value, and thus give the impression that right is safe and wrong is unsafe. A rule-based method with effect lines/threshold values raises the suggestion that fire safety can be switched on or off. This could not be any further from the truth. In the set of rules that apply to the fire protection of buildings, whether or not individual rules comply with threshold values says little about the degree of fire safety. What matters is achieving a fire safety level for a certain building. This requires an integrated approach based on the correlations among fire, building, human, environmental and intervention characteristics. Such an approach is pre-eminently risk-based: there is improved equivalence or 'fire safety engineering' (FSE).



## 2.2 Fire prevention triangle

The fire prevention triangle is a model based on the current shortcomings in the implementation of rule-based fire prevention. Rules, knowledge and experience play a role in the model. Experience as a basis is an important factor in order to be able to properly deal with fire prevention.

Applying a risk-based approach does not make a rule-based method redundant. Rules containing a general risk approach suffice for non-complex and low-risk buildings, as the majority of buildings fall in this category. They can be classified as belonging to the 'standard' category and are estimated to account for 75% of the total number of buildings. See Figure 18. The figure shows the standard category in the bottom part of the triangle. Assessing fire safety in this category mainly requires skills in applying rules.

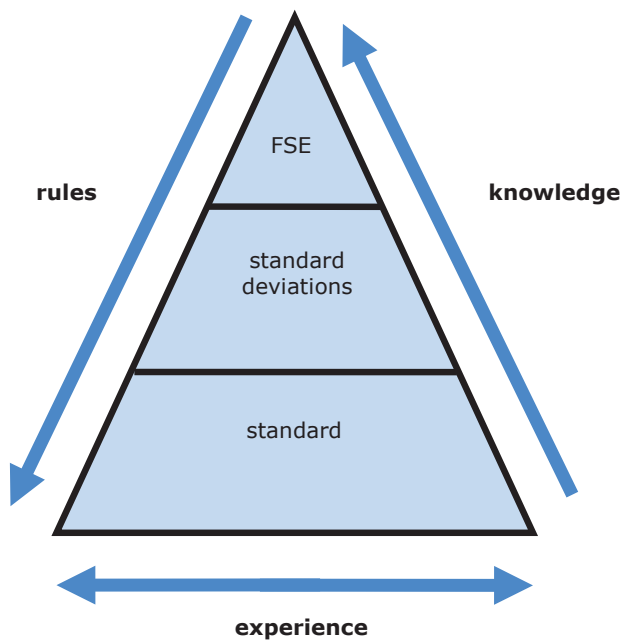


Figure 18 Fire prevention triangle

The risk-based approach mainly focusses on complex and/or high-risk buildings. This is the apex of the triangle in the figure. Assessing fire safety in this category requires a bespoke approach, specifically aimed at the object in question. This requires specialist knowledge of fire characteristics, building characteristics, human characteristics, environmental characteristics and intervention characteristics. Here, the rule-based method serves as a reference. It is less important how skilled people are at applying rules. The central area in the figure shows the category of standard deviations. Assessing fire safety in this category requires a semi-bespoke approach that can be applied to certain categories of buildings. Standard scenarios can be chosen as the risk approach here. This often also requires specialist knowledge of fire characteristics, building characteristics, human characteristics, environmental characteristics and intervention

characteristics. Here, the rule-based method serves as a reference. The demarcation between standard, standard deviation and FSE is not very distinct. The areas merge into each other as it were. The arrows indicate the components of experience, rules and knowledge. The experience component is narrower at the apex of the triangle, and there will be less use of rules and more of a requirement for knowledge there than at the bottom.

### 3. Risk-based fire prevention

The standard fire curve is predominantly used as a reference for fire protection in rule-based fire prevention. This is a conventional nominal temperature/time curve. The fire is described in terms of temperature (in °C) and time (in minutes). The standard fire curve, as part of a fire scenario, is too restricted to enable fire protection options to be matched effectively with specific risks of a building. A risk-based approach, based on a method with a natural fire development, offers better possibilities of coordination and, as a result, better possibilities for choices. Risk-based fire prevention, i.e. fire safety engineering, is the subject of chapter 3.

Note:

Special fire curves, such as the hydrocarbon curve and the reduced fire curves, have not been considered here.

#### 3.1 Natural fires

Instead of applying the standard fire curve as a reference, physical fire models are applied to natural fires. These models provide a more realistic approach to the fire development using heat release rate scenarios. Contrary to the standard reference that only considers a fully developed fire, a natural fire has growth and decay phases. The temperature development during a natural fire depends on the specific conditions of the room and its contents (if combustible). The energy (heat and smoke) of a natural fire is characterised in terms of the heat release rate density (in  $W/m^2$ ) and time constant (in sec). You can find further information about natural fires and physical fire models in chapter 3.

## 4. The cascade model

The Netherlands Institute for Safety (NIFV) initiated a research programme with the objective of improving fire safety in the Netherlands. Research into fire development is the central element of this programme. This research should provide a better understanding of the factors that determine the variations in fire development. The knowledge acquired should enable repressive fire-fighting and fire prevention in buildings to be optimised.

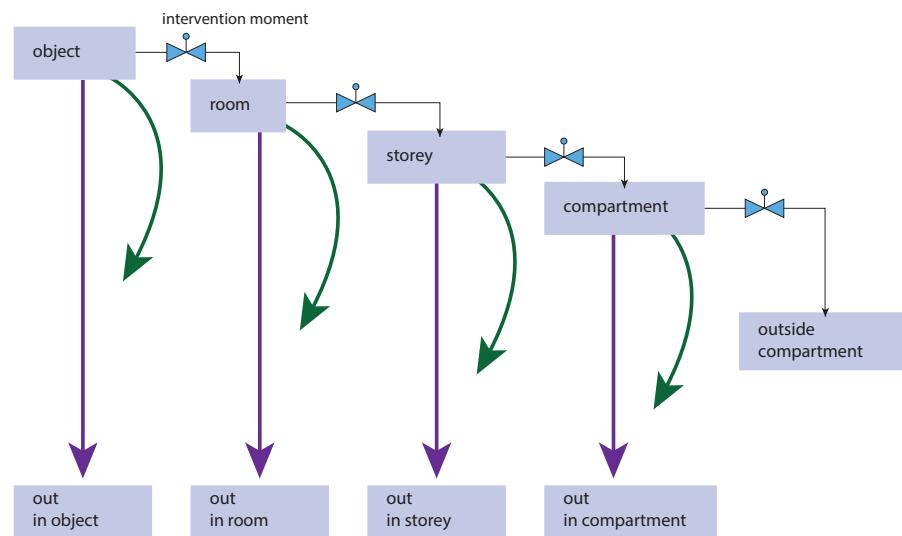
Initially attempts to gain a better understanding focused on studying the development of temperature or heat radiation as a function of time, i.e. the fire curve, but it was found that the fire curve is of little use for improving fire safety. Since a fire curve is a very global approach to the manner in which temperature (or heat radiation) develops in a certain room and under certain conditions, it does little justice to the variation resulting from other conditions, such as a different volume, different ventilation, and different materials. And furthermore, temperature or heat in a room is not the predominant factor for fire safety. The spread of fire and, particularly, smoke are found to have a much more crucial effect on such aspects as people's chances to escape and the occurrence of material damage. This has led to the recent development of a new model, the cascade model. This model can be used to study actual fires. It generates data for evaluation and optimisation. The spread of fire and smoke play a role in the model. Smoke at eye level affects people's vision, making it impossible for them to properly find their bearings in a building, while inhaling combustion products negatively affects their responsiveness and powers of orientation. And finally, harmful substances in the smoke and the heat of the fire gases may cause acute death.

The cascade model assumes five fire phases. In the model, a fire makes transitions through different phases that can be differentiated from each other on the basis of the area affected: from object to room to the further surroundings (storey, compartment). The spread of smoke will always have progressed at least one phase further than the fire has spread. There are two options in every phase: the fire is extinguished or it makes a transition to the next phase. The latter option depends on a large number of factors, such as preventative measures and facilities, the behaviour of the people present and repressive action by the in-house emergency responders and the fire service. By closing a 'valve' in the model, as it were, a fire or the smoke cannot grow or develop any further.

Figure 19 shows a diagram representing the model. The extent of the fire and the spread of smoke and fire have been divided into the following cascades:

- limited to the object where the fire started
- limited to the room where the fire started
- limited to the storey where the fire started
- limited to the compartment where the fire started
- outside the compartment where the fire started.

If the size and layout of a building is such that a storey consists of several fire compartments, the third and fourth cascade trade places with each other. If a storey is the same as a fire compartment, there is one cascade in the third and fourth phases.



**Figure 19** Cascade model

The cascade model is both a qualitative model, enabling a more detailed look at fire behaviour, and a quantitative model, enabling statistical analyses to be made. It does justice to the dynamic nature of fire. Fire growth can be considered in terms of the different phases as differentiated by the cascade model. The aspects and measures that determine the transition from one phase to the next, or for preventing such transition, can be taken into consideration here. Common risk analysis methods, including the bow tie model in conjunction with fault trees, may provide an understanding of why the transitions occur. The cascade model has shown its value in fire service education and in research into, and in the forming of opinions about, such issues as offensive attack from the outside and reducing unnecessary turnouts.

## 4.1 First cascade

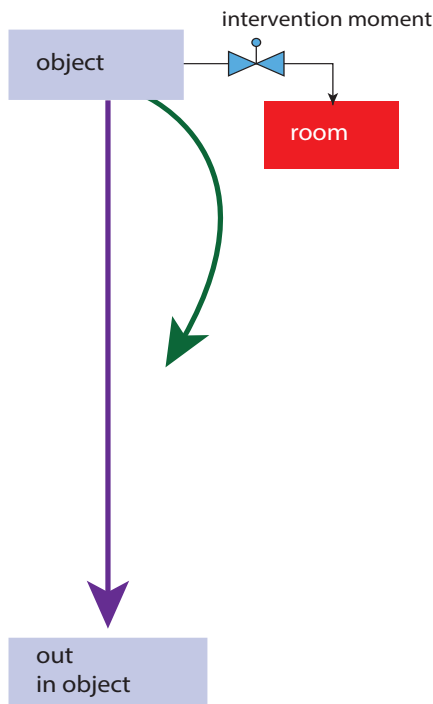
In the first cascade, the fire is still limited to the object where the fire started. It can mostly still be put out using small fire extinguishers. Figure 20 shows a diagram representing the first cascade.

### This is illustrated by the following example

The fire started in a wastepaper basket next to a cupboard in a room. Initially, only the wastepaper basket is on fire. The heat of the fire causes the smoke, containing flammable gases, to rise in the room. Heat is stored in the solid, visible particles of the smoke, the carbon particles. This makes smoke itself an important means of transport for heat. Smoke is also a combustible substance. In this phase, the fire is limited to the object where it started, but the smoke has developed to the next stage or further: the room where the fire started.

The fire may escalate to the next cascade, fire in the room, depending on a number of factors:

- The fire has sufficient fuel/energy to heat up the direct surroundings such that pyrolysis occurs and other objects catch fire as well.
- The design of the wastepaper basket, e.g. self-extinguishing.
- People intervening with a small fire extinguisher.



**Figure 20** First cascade

The intervention perspective for this cascade is as simple as it is effective. The use of a small fire extinguisher or plain water will suffice to quell the fire. If the fire has sufficient fuel/energy, is not in a self-extinguishing wastepaper basket and there is no human intervention, the fire will grow to the next cascade: fire in the room.



Fire limited to an object

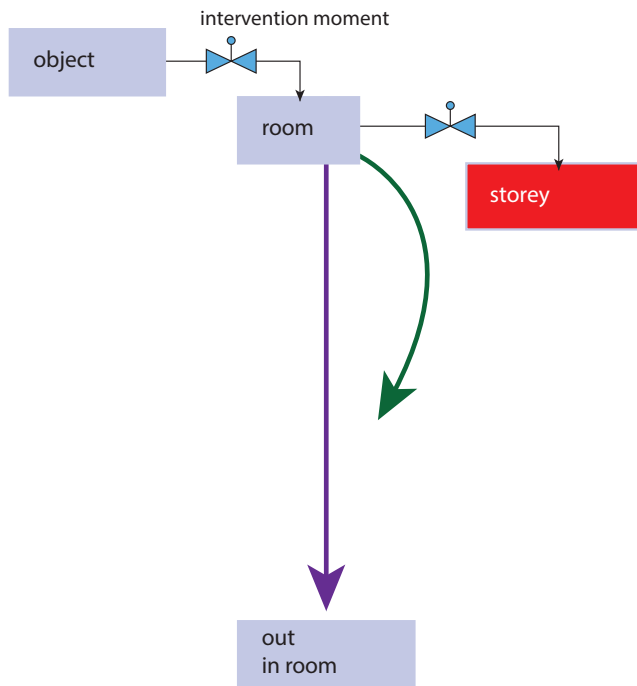
## 4.2 Second cascade

Once the fire has made the transition to the second cascade, it will take on the size of the entire room. Figure 21 shows a diagram representing the second cascade.

Usually, fighting the fire with small fire extinguishers is out of the question at this stage. An exception to this is a small room with a limited amount of combustible material. Intervention by the fire service will usually be required. Again, it is important to note that the smoke has progressed at least another cascade further. The smoke, containing combustible substance and heat, is already at the level of the storey.

The development may stop in several ways:

- There will be insufficient oxygen to keep combustion going, quelling the fire. Initially, there is a smouldering fire, but when all the oxygen has been used up, this form of fire will extinguish itself. What follows is a ventilation-controlled fire. This brings the risk of backdraft.
- The separation walls and the doors in them have sufficient resistance to the fire and do not collapse nor burn through. In this event, the combustible material in the room can burn up without the fire spreading to the rest of the storey. The temperature of the smoke is a critical factor here, since hot smoke may also cause fire to spread.
- The fire is extinguished before the flames reach the next cascade.



**Figure 21** Second cascade

The intervention perspective for this cascade is still rather simple, but has to be performed by the fire service. The risks have become such that it is no longer safe for unprotected and untrained people to intervene.

The fire service's attack consists of the following steps:

- cooling the fire gases to below their ignition temperature
- ensuring natural ventilation of the room
- extinguishing the fire.

If the fire can develop sufficient energy, the partitions between the room and the storey have insufficient resistance and the fire service will not intervene, the fire will grow and make the transition to the next cascade. The entire storey will then be affected by the fire.



### 4.3 Third cascade

A fire that has not stopped in the second cascade will grow and make the transition to the third cascade. Figure 22 shows a diagram representing the third cascade. The entire storey may catch fire. This may be a large surface, depending on the type of building. In this situation, the size of the fire may be such that one fire service unit no longer suffices to fight it. If the compartment has several storeys, the risk of the fire growing to fill the entire size of the compartment must seriously be taken into consideration. Again, it is important to note that the smoke has progressed at least another cascade further. The smoke and the combustible substance and heat contained within it is already at the level of the compartment.

The development may stop in several ways:

- There will be insufficient oxygen to keep combustion going, quelling the fire. Initially, there is a smouldering fire, but when all the oxygen has been used up, this form of fire will extinguish itself. What follows is a ventilation-controlled fire. This brings the risk of backdraft.
- The separation walls and the doors in them have sufficient resistance to the fire and do not collapse or burn through. In this event, the combustible material in the room can burn up without the fire spreading to the rest of the storey. The temperature of the smoke is a critical factor here, since hot smoke may also cause fire to spread.
- The fire is extinguished before the flames reach the next cascade.

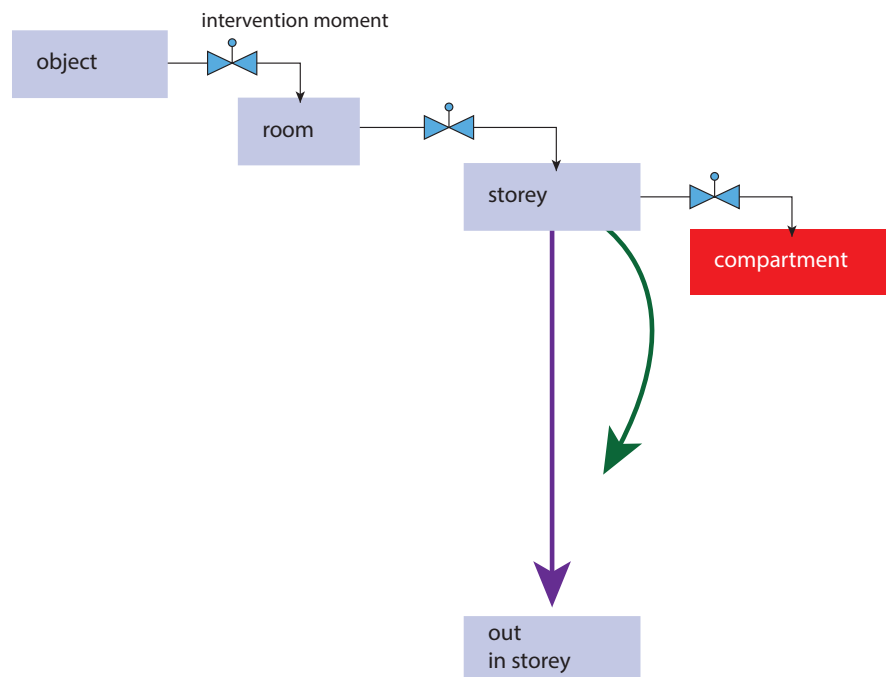


Figure 22 Third cascade

The intervention perspective for this cascade is a bit more complex. Those in charge (crew commanders and fire operation commander) will have to consider whether defensive or offensive attack is possible and/or required. If rescuing people is not necessary, lowering the temperature will be one of



the first aspects so that both the load-bearing and partitioning structures will have a much lower heat load to contend with. Possibilities are:

- cooling the fire gases
- repressive ventilation
- a combination of cooling the fire gases and ventilation
- extinguishing the fire.

If the fire can develop sufficient energy, if the partitions between the storey and the compartment have insufficient resistance and if the fire service does not or cannot intervene, the fire will grow and make the transition to the next cascade. The entire compartment will then be involved in the fire.

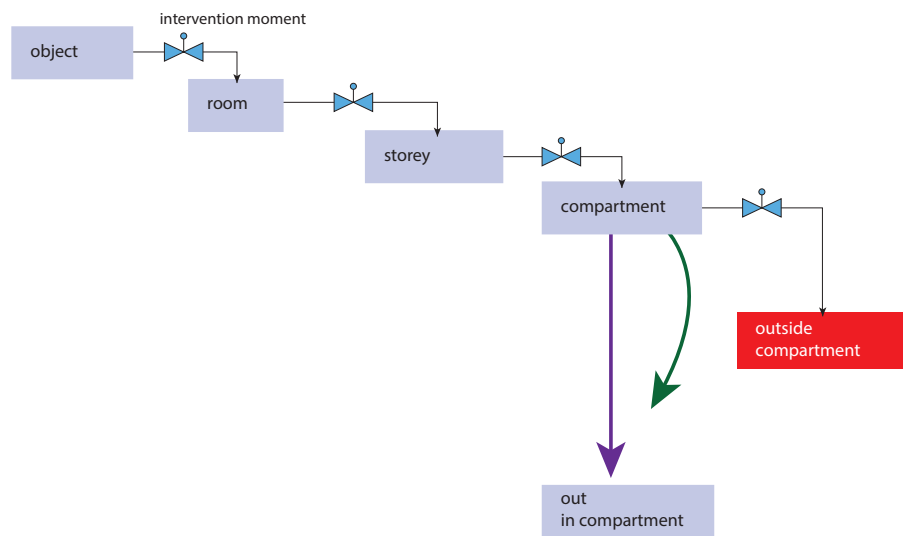


#### 4.4 Fourth cascade

If the fire has made the transition to the fourth cascade, the entire compartment has become involved in the fire. Figure 23 shows a diagram representing the fourth cascade. This may be a very large surface, depending on the type of building. In this situation, the extent of the fire has become such that it can only be fought by deploying several fire service units. If the compartment consists of several storeys, the possibility of the fire exercising such a great heat load on the building's load-bearing structure that its collapse may be a major risk for the units deployed must be seriously taken into consideration. Again, it is important to note that the smoke has progressed at least another cascade further. The smoke, containing combustible substances and heat, is already outside the compartment.

The development may stop in several ways:

- The dividing walls and the doors in them have sufficient resistance to the fire and do not collapse or burn through. In this event, the combustible material in the room can burn up without the fire spreading to another storey. The temperature of the smoke is a critical factor here, since hot smoke may also cause fire to spread.
- The fire is extinguished before the flames reach the next cascade.



**Figure 23** Fourth cascade

If the fire can develop sufficient energy and if the fire-resistant partitioning structures between compartments have insufficient resistance given the fire load present, and if the fire service fails to intervene or cannot intervene, the fire will grow to the next cascade where it extends beyond the compartment.

## 4.5 Fifth cascade

The fifth and last cascade of the model sketches the situation where the fire has grown such that it has spread outside the compartment. When that happens, the fire service will only be deployed outside the building. The choice of offensive attack or defensive attack is made depending on the building's contents and on how well the seats of the fire can be reached. Offensive attack means a direct attack, i.e. extinguishing the fire. Defensive attack aims to protect the surroundings, while sacrificing the compartment, the premises. There will often be a large-scale fire service attack in order to achieve the goal.



### *The expression 'building fire'*

The expression 'building fire' may lead to confusion. Does it mean a fire in a building or a building on fire? Obviously, this is an essential difference. A fire in a building means that the fixtures and fittings of a building are on fire. The building materials of which the actual building is constructed are not burning or are not yet significantly affected by the fire. If a building is on fire (a 'building fire') the fixtures and fittings are on fire and the building materials are also burning or are significantly affected by the fire. A building on fire poses much more threat than a fire in a building. If there is a fire in a building, the building's structure is still reliable, whereas if a building is on fire this is not always true anymore.

## **Chapter 3**

### **Risk-based fire prevention (FSE)**





## Introduction

Fire safety engineering (FSE) is a discipline that is increasingly applied to fire safety. Given the great attention it receives at present, many people seem to consider FSE as the number one instrument that will help to solve all problems relating to the fire protection of buildings. However, opinions differ on how to implement FSE. The objective of this chapter is to further explain the concept, contents and methodology of FSE. Section 1 sketches the concept of FSE and its scope. Section 2 addresses the key parts of FSE: a phased risk approach plan, scenarios and the instruments that are to be used. Section 3 deals with the process and working method that play a role in FSE, the key elements of which are the interactions between stakeholders, the market and the government, and the method of reporting.

Actually, FSE is not a new field of study. These developments started in the UK in 1918. When performance-based design became popular in the UK and the US in the mid-twentieth century, this method was given further impetus. In terms of their objectives, buildings have to comply with performance requirements, instead of with strict rules. This method has led to a turn away from the mere application of rules and towards thinking about fire safety, resulting in ever more alternatives to traditional solutions. The alternative solutions are FSE solutions: fire engineered solutions.

Designing and assessing an FSE solution requires a specific approach in which risk approach comes into play. This can vary from having the risks assessed by one or more experts or assessing the risks based on an analysis of documents. Implementation is based on expertise. A precondition is that the protection objectives are clear.

The methodology for an FSE solution can be compared to and integrated with the procedure consistent with the principle of equivalence from the prevailing building regulations. There is no fundamental difference. An FSE solution is also about achieving at least the fire safety level envisaged through legislation. It should be noted here that the actual details of equivalent solutions in current implementation practice are often considered from the sector-specific philosophy of the building regulations. This definition is often found to be too limited, resulting in hiatuses. Fire safety is more than just building. It is about an integrated way of thinking, based on environmental characteristics, fire characteristics, building characteristics, human characteristics and intervention characteristics.

## 1. Fire safety engineering

Fire Safety Engineering is about 'applied fire safety science', i.e. the scientific assessment of fire safety based on:

- the typical characteristics of a fire (fire physics)
- a building's design (construction engineering and architecture)
- people's behaviour (behavioural science).

The competency of conceptual thinking and an expert opinion play leading roles in this. Here, 'scientific substantiation' means careful, verifiable and systematic substantiation. Scientific research reports may be part of this (see also chapter 7).

The European Commission has defined FSE as follows:

Fire safety engineering is the application of:

- basic design assumptions
- regulations and an expert opinion that is based on a scientific assessment of:
  - the fire behaviour
  - the effects of fire, and
  - people's reaction and behaviour,

in order to:

- reduce casualties
- protect property and the environment
- quantify the danger and risk of fire, as well as the effects of fire, and to
- evaluate the optimum protective and fire preventative measures needed to reduce the consequences of fire – within pre-defined levels [EC, 2002].

### 1.1 Conceptual thinking

A precondition for conceptual thinking is that the parties involved can form a wide and deep understanding of fire safety. They must be able to place problems and situations in a comprehensive and/or more abstract framework. The parties involved must also have and retain a picture of the outlines and main implications of an idea. Key terms in conceptual thinking are:

- *Abstracting*: formulating a problem in general terms, placing a problem in a more abstract framework.
- *Switching*: switching from concrete to abstract thinking and back from abstract to concrete thinking. Being able to translate an analysis into concrete solutions.
- *Generalising*: dealing with a problem and tackling it as if it belonged to a category of similar problems. Seeing the general aspects of the concrete problem at hand. Being able to come up with structural solutions.
- *Seeing the implications*: recognising what the implications of an idea or a conclusion are. Having and keeping a picture of the outlines and main implications of an idea.
- *Relating*: providing an understanding of a problem or an idea by relating it to other ideas or problems. Being able to look beyond the boundaries of one's own field of expertise.

The ability to think conceptually requires the analytical and strategic ability to look at problems from several angles.

Implementing conceptual thinking for the fire safety of buildings requires a broad perspective on and an understanding of the aspects of fire safety and the associated risks, possibilities and impossibilities of fire protection options. This requires knowledge of the starting points for the building as regards the technical aspects of the design, statutory and other rules, including their objectives, sub-objectives and basic assumptions, and knowledge of intervention by in-house emergency responders and the fire service. Expert opinion plays an important role in defining the protection options as the choices made are partly based on this opinion.

## 1.2 Expert opinion

Expert opinion comes into play when designing and evaluating equivalent fire safety, regardless of whether FSE techniques are used. In this sense, FSE is just a refined form of equivalence. Expert opinion plays a role in the interaction - often in a force field of interests - between parties involved from the market and the government. Expert opinion is an unknown and uncertain factor in this. The parties involved do not have the same level of knowledge, which may lead to insufficient or excessive solutions.

### *Cooperation among parties involved*

Putting an end to this 'asymmetry' of knowledge is an important factor for a successful approach to FSE solutions at project level. The question is how this can be achieved. The available knowledge about fire safety and associated risks covers a wide area and relates to such topics as environmental characteristics, fire characteristics, building characteristics, human characteristics and intervention characteristics. Not all details of this knowledge are combined in one person or one organisation. Education is a partial solution for putting an end to this asymmetry, but it will never suffice on its own. Communication is the other part of the solution by enabling adequate interaction between parties from the market sector (e.g. a consultancy firm) and the government (e.g. the fire service). A complicating factor is that this interaction is often accompanied by differing interests, where several, and sometimes conflicting, expert opinions may play a role. Conflicting expert opinions are often the result of a difference in knowledge, understanding, basic assumptions and choices. Risk perception and risk acceptance form part of it and sometimes also risk aversion. Furthermore, various interests can play a role. Communication and mutual comparison of expert opinions bring gaps in knowledge out into the open and offer improvement possibilities. Putting an end to the knowledge asymmetry requires good interaction between the parties, which should be based on mutual respect and trust and the right division of responsibilities.

## 1.3 Project analysis

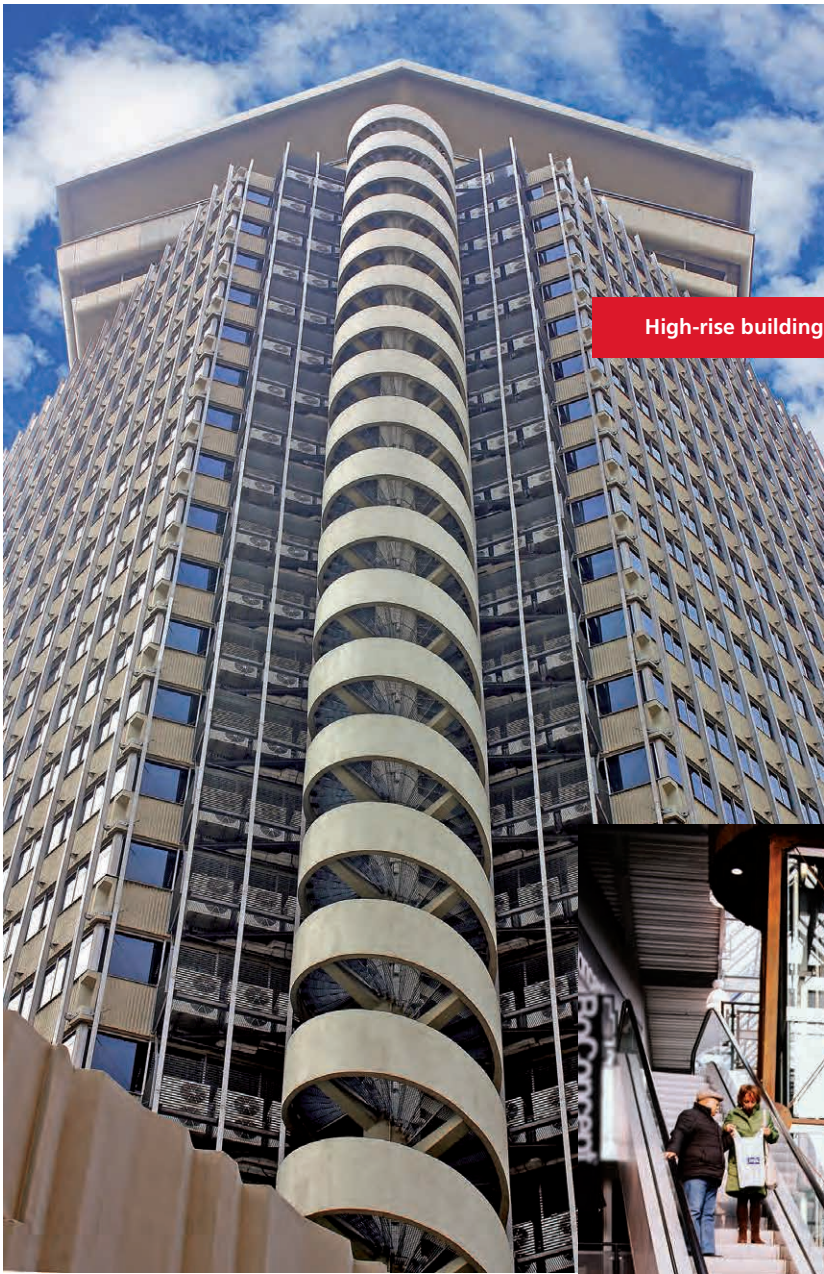
An analysis of some 20 recent and current projects (National Fire Academy, Netherlands Institute for Safety (NIFV)) where FSE was used confirms this knowledge asymmetry. The analysis revealed the following picture:



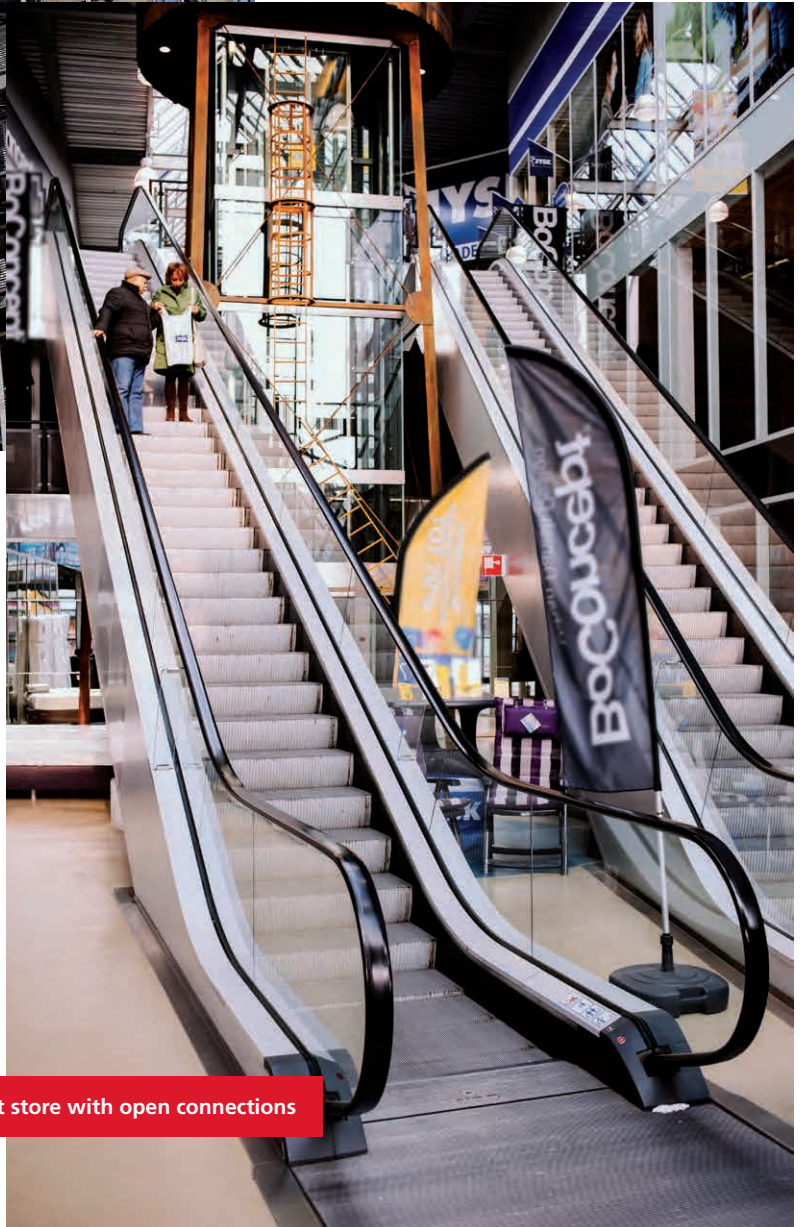
- The approach employed with FSE is often based on rules found in building regulations and not on safety, or more specifically fire safety, when combining environmental characteristics, fire characteristics, building characteristics, human characteristics and intervention characteristics.
- In a substantial part of all buildings, the choice of protection options in the building leads to uncertain safety since the fire service's repressive strength has already been taken into consideration.
- The choice of protection options is not based on risk analyses. Solutions are devised without properly exploring and analysing the problem, and without giving it enough thought.
- FSE is often addressed at a late, or too late, stage. It is true that any gaps will have been recognised by then, but it can frustrate suggestions for effective solutions.
- Lots of problems can be traced back to miscommunication. There is a lack of adequate interaction between the market and the government.
- The different parties have different kinds of knowledge and the progress of the operation leaves a lot to be desired.
- FSE reports have been written such that assessing them is very difficult or impossible for the government.
- The assumptions in FSE reports are often optimistic when compared to the risk. Optimistic input generates optimistic output, leading to a failure to cover risks sufficiently. This leads to substandard fire protection measures and/or facilities.
- Advice that is provided by the market sector often seems to involve commercial interests. This is particularly so if manufacturers and/or suppliers are involved. Fire safety is then not the central issue.
- The fire service thinks that occupants/users should be involved, which is not the case at the moment. The fire service is often confronted with protection solutions that have been devised by technical engineers but which limit occupants in ways they do not want.

#### 1.4 Fire safety engineering: a risk-based method

Fire safety can be divided into three segments, i.e. fire safety science, fire safety engineering (the application of fire safety science), and fire safety tools. Fire safety science includes scientific knowledge of the chemical and physical aspects of fire and the aspects of human behaviour in the event of fire. For example, this science addresses fire behaviour and its relationship with the environment, as well as human behaviour when fleeing in the event of a fire. Scientific knowledge serves as the basis for the development of fire safety tools (FS tools) and partly contributes to the development of legislation. Examples of FS tools, also known as 'models', are design and assessment instruments and simulation software. FSE engineers make use of and apply the knowledge developed in fire safety science. FSE engineers have a wide range of instruments, consisting of documents and models, i.e. the tools, at their disposal for this.



High-rise building



Department store with open connections

### Comparison between rule-based and risk-based

Achieving protection objectives is the key element of fire prevention. It does not matter whether this is done using a system of rules, the rule-based approach, or using a system in which risks and models play a role, the risk-based approach. Both methods should be compatible with the model-based approach, i.e. the framework for fire prevention, as described in chapter 1. Figure 24 shows the typical differences between these two methods. Equality before the law is provided by an efficient process (see section 3).

Rule-based	Risk-based (FSE)
Prescriptive system	Performance-based system
Based on agreements	Based on risks
Normative fire development	Natural fire development
Coarse-meshed	Fine-meshed
Conservative	Progressive
Frustrates innovation	Promotes innovation
Hardly suitable for bespoke solutions	Suitable for bespoke solutions
Relatively simple	More complex
Unambiguous	Not unambiguous
Equal before the law	Less equal before the law or less probability of being equal before the law

Figure 24 Typical differences between rule-based and risk-based (FSE)

The many performance rules contained in the Dutch building regulations have made these regulations a prescriptive system. As it is hard to recognise the interrelationships between the different rules, individual variables are assessed on the basis of individual threshold values, whereas in the real-world situation, they are intertwined. The specific characteristics of a building, including aesthetic characteristics, play no other role than that of the purpose of the building. Risks play a very limited role in the rules contained in the building regulations. It is a deterministic system that employs the threshold values of right and wrong and is based mainly on past agreements and experiences. There is little scientific input (see chapter 7). The system of rules with a traditional, architectural approach, based on a standard fire development, leads to passive fire protection options. The result is that active fire protection options are hardly given any attention. Building regulations are a system with a relatively crude indication of functions and building purposes, making bespoke solutions difficult to achieve. Human behaviour is not taken into account. The specifics of the building regulations are insufficient for providing equivalent fire safety solutions for the building industry, let alone in relation to integrated fire safety, including occupancy and intervention.

However, this does not mean that the rules provided in the building regulations are difficult to apply or that they lead to unsafe situations. In many cases, the performance rules do lead to sufficient fire safety. Providing a bespoke solution is not relevant then. On the other hand, the set of performance rules is too limited for high-risk and/or complex buildings or parts thereof. The characteristics specific to such buildings cannot therefore be given due weight.

This limitation can be removed by using a performance-based system. In terms of their objectives, buildings have to comply with performance requirements, instead of with strict rules. This method has led to a turn away from the mere application of rules and towards thinking about fire safety on the basis of common sense and thorough knowledge of the subject matter. This produces alternatives to traditional solutions. These alternative solutions are FSE solutions. A performance-based system for assessing the fire safety of buildings is a method based on risks. The current and also common practice of implementing fire safety is characterised by a probabilistic and qualitative approach. Scenarios define the standard. Considerations based on expertise play a role. If applied properly and expertly, FSE may provide the answer to the limitations that are inherent in the performance requirements of the building regulations. In the context of the equivalence principle, FSE can be used for only part of a building or for an entire building.

Note:

An adequate quantitative method for the approach to fire safety based on risks is as yet impossible. In addition to research, such a method requires the availability of information about the causes of fires and consequences of fire, based on case histories and statistics. The problem is that too little information about this is available and what there is tends not to be sufficiently in depth. Where more information is available, e.g. in residential construction, a semi-quantitative approach may be applied. It is safe to state that the developments as regards risk assessment methods for the fire safety of buildings are still in their infancy and that research into this specific area is necessary.

Figure 25 provides a more in-depth elaboration of the summary of characteristics from chapter 1 by adding the FSE tools in the periphery. The summary shows the combination of the characteristics for fire safety and the application of models that can play a role in FSE. Designing FSE solutions is about influencing the conceptual framework (resulting in the degree of fire safety) other than only by means of rules. Physical and empirical models now come into play. The blue arrows indicate the interrelationships between the models. Some examples of models are a fire model, an analysis model for escape safety and intervention models for the response. When applying the models, fires should be considered from the point of view of scenarios. Using scenarios sheds light on the interrelationships that play a role in the fire and in fire safety.

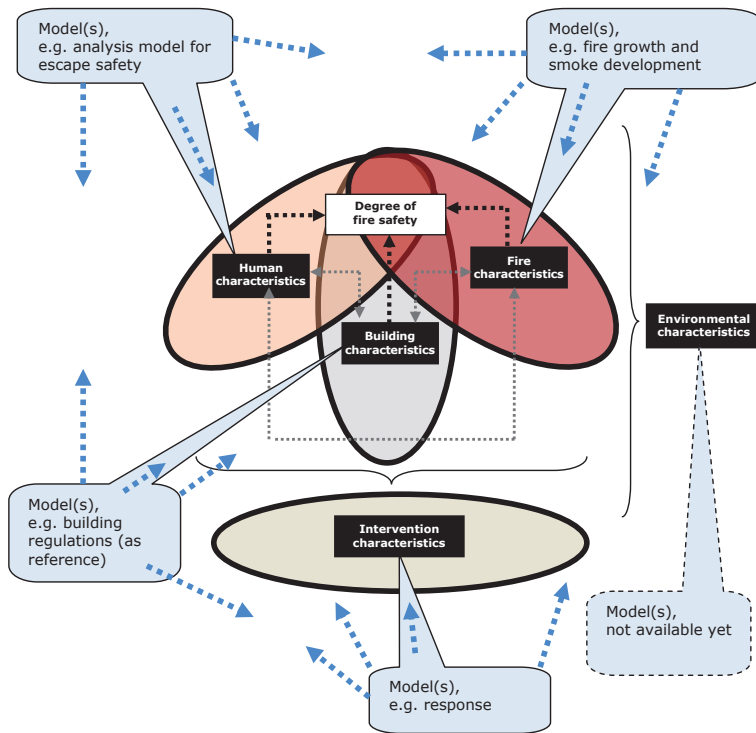


Figure 25 Summary of characteristics with FSE tools

## 2. Fire safety engineering in practice

As is the case with a rule-based approach, FSE represents an adequate fire safety level. The difference is in the approach. And what's more, an FSE-based approach should make sense (see the fire prevention triangle in chapter 2). FSE involves a risk approach. It is about obtaining the best possible understanding of the impact of a fire that can be expected in a building, with the objective of providing the building with effective fire protection and maintaining this fire protection. Aspects such as keeping the escape routes intact for a certain time, fire compartmentation and construction play a central role. A special element for FSE is people's behaviour in the event of a fire.

Note:

A rule-based approach centres on the rules and requirements provided by regulations. Human behaviour in the event of a fire has not been taken into account here. This does not mean that it is not possible to take this into account. For example, if it is clear that human behaviour negatively affects escape safety, that aspect should be tabled in good time in order to eliminate the negative consequences as effectively as possible. The fire service can ensure this happens. The applicant/user of a building is responsible for this.

As is the case with the rule-based approach, the result of an FSE solution should also be that the building offers sufficient protection against the signs of flames, energy and smoke that are inherent in a fire. The stability of the structure mainly depends on the temperature. Increases in temperature may reduce a structure's strength and rigidity, which might lead to the structure

failing due to its no longer being able to bear the load to which it is subjected. In addition to protection against temperature, protection against smoke is also important for people's safety. This concerns the loss of sight and exposure to toxic substances as well as exposure to hot gases and heat radiation from a layer of smoke. It is evident that there is also a relationship between the stability of the structure and people's safety.

In the event of a fire, heat transport mechanisms such as conduction, convection and radiation may cause a building's structure or a part of the structure to become unstable. Heat is transported from hot to cold.

### **Conduction**

Heat conduction in solids is caused by a difference in temperature, e.g. due to a fire in a room, which makes its temperature higher than that in the adjacent room. Heat will be transported through the partitioning structure between the two rooms, depending on the composition of the partitioning structure.

### **Convection**

Heat convection only occurs in liquids and gases. It is caused by a difference in pressure. When a fire occurs, this difference in pressure is often caused by a difference in temperature and heat is transported due to the fact that hot air rises.

### **Radiation**

Heat radiation is caused by electromagnetic waves, e.g. from the flame of a fire. Heat may be transported by such radiation. A transport medium is not necessary. Heat transport due to radiation may also occur in a vacuum.

To determine the extent of fire safety required, when opting for an FSE solution or any other solution, the objectives and basic assumptions of several interrelated statutory schemes have to be taken into consideration in order to achieve an integrated protection result. The most important statutory schemes are those for construction (the Dutch Housing Act (*Woningwet*), and the Dutch Building Decree), the in-house emergency response (the Dutch Working Conditions Act (*Arbowet*)) and the fire services (Dutch Safety Regions Act (*Wet veiligheidsregio's*)). The statutory schemes are the reference for determining the minimum protection options required. Furthermore, it is up to the owner or occupants to decide, partly in view of the duty of care (as referred to in section 6.174 of the Dutch Civil Code), whether additional measures, other than those defined in the law, are necessary in order to sufficiently guarantee the health and safety of the occupants of the building and of third parties.

Chapter 4 lists several areas that require special attention as regards the fire protection of buildings. As they indicate an integrated approach to fire protection, matching the basic assumptions of the applicable Acts (Housing Act, Building Decree, Working Conditions Act, Safety Regions Act), they are suitable for use as references.

## 2.1 Six-step risk approach

As yet, the approach to the fire risks is probabilistic and qualitative (see chapter 5). Fire scenarios define the standard in a risk approach to fire safety. Figure 26 shows a diagram of a six-step risk approach. The main thing is to consider and assess the interrelated risks. The key idea behind this approach is that the risks of the building or a part thereof should be set against the risks that people will fall victim to the effects of a fire. This approach can also be applied to the risks of damage or loss.

An important aspect of this approach is to take account of the context in which protection measures are required from the perspective that absolute safety cannot be assured and we should not pretend that it can. Safety risks must be minimised as far as is reasonably feasible.

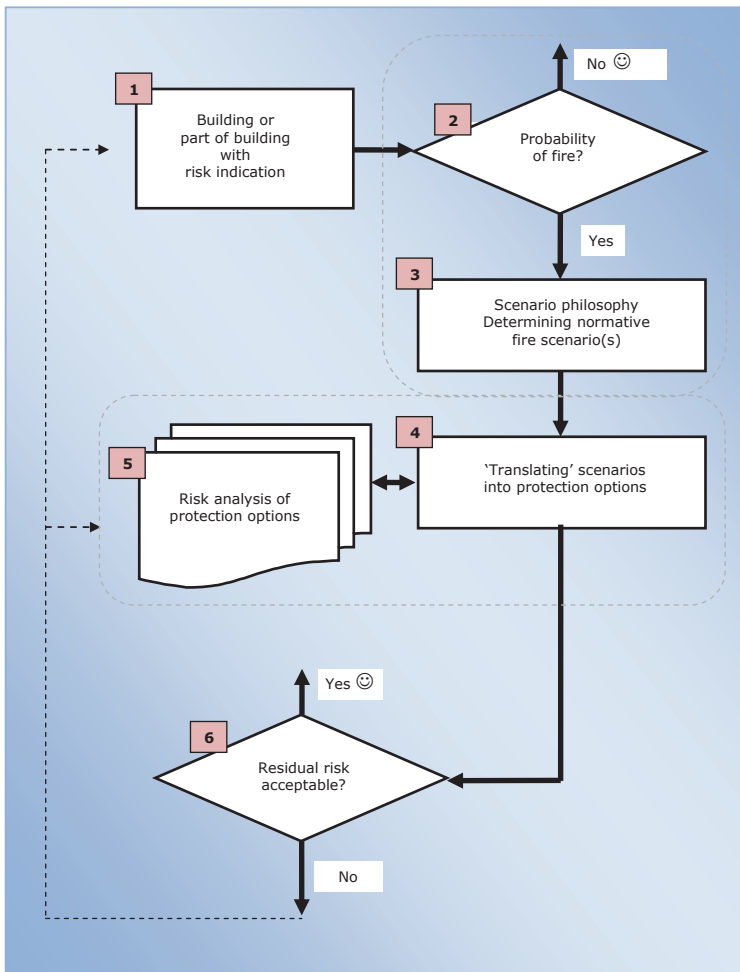


Figure 26 Diagram of six-step risk approach

### Step 1

The first step should provide information about the design of the building or part of the building, for example information about its purpose, construction, escape routes and fire compartmentation and about the context in which protection against fire is required. This step should also provide an insight into the risks that may play a role and that have to be taken into account (table 1 of chapter 5 is a model for the risk indication of buildings). This model enables a transparent risk assessment to be drawn up. This assessment generates information that can be applied in a risk analysis. The result of this step gives the parties involved a picture of the building in combination with the risk factors. It puts the building that is to be protected into the right perspective and invites the people concerned to think carefully.

### Step 2

The second step requires a decision to be taken on the probability of a fire starting. If this probability is zero, there is little sense in implementing fire protection. This is the first point where a risk-based approach differs from a rule-based approach. If there is a probability of a fire occurring, implementing fire protection is the obvious route to take. The question then is about the degree to which protection should be provided. Answering this question requires an insight into the probability and the possible consequences of fire.

Assessing the probabilities and consequences requires expertise. As yet, this assessment focuses on quality aspects. Statistics, case histories and data from fire research can be used as sources of information. If insufficient information can be gathered from statistics and case histories, expert opinion will have to be relied upon in the main. The result of this step is that the parties involved have an idea of the probability and the consequences of fire. Important considerations in this step are:

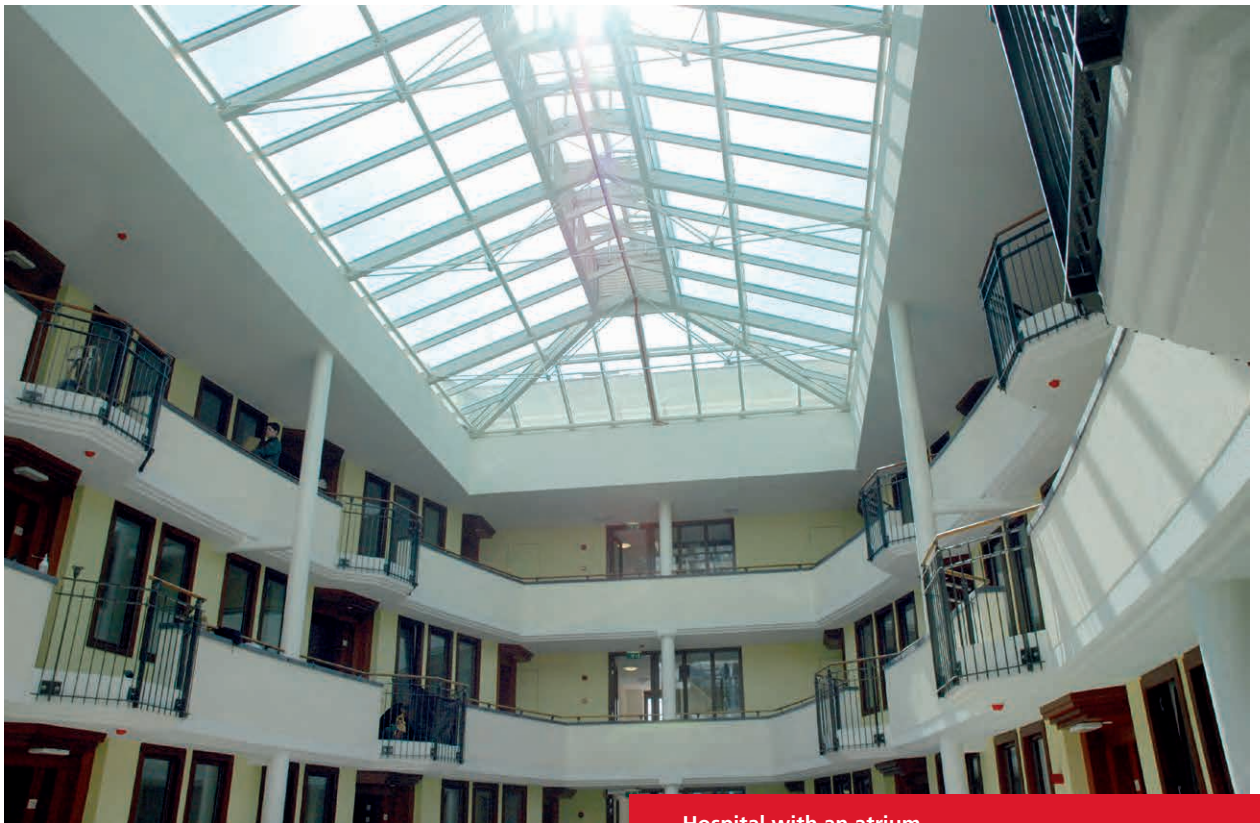
- can an initially minor fire develop into a relevant, normative fire?
- can the fire spread to other objects, for example due to heat radiation or to direct contact with flames?
- can an explosive ignition occur due to explosive gases or vapours?

The results of steps 1 and 2 provide the parties involved with specific information about a building. This information serves to indicate which fire protection is required.

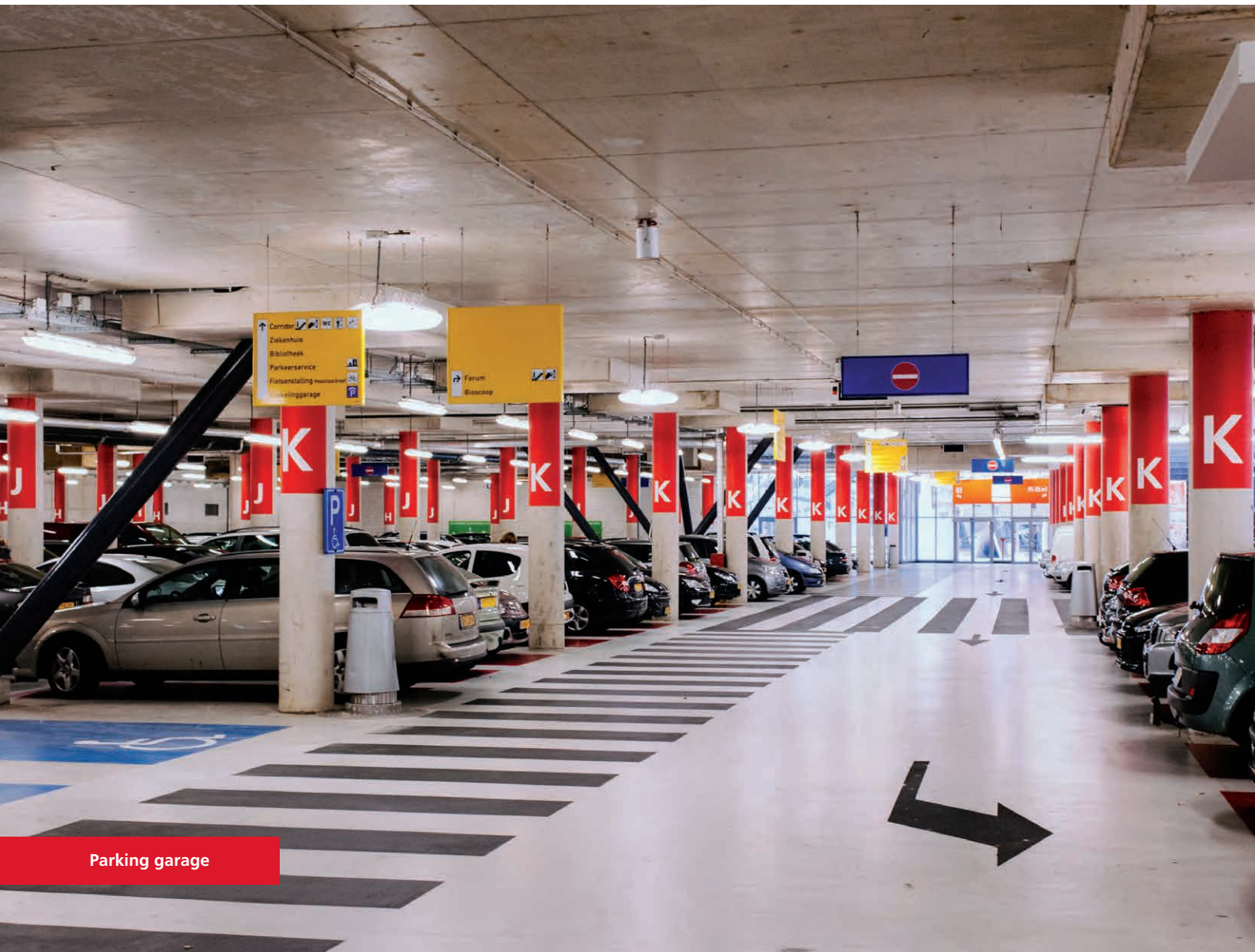
#### *Note:*

From a legal perspective, the fire safety level envisaged by the legislator applies as a minimum requirement.





Hospital with an atrium



Parking garage

### Step 3

The scenario philosophy is a key issue in the third step: one or more normative fire scenarios have to be defined in this step. Risk analysis is not possible without scenarios. Scenarios identify the norm for the eventual fire protection facilities and measures that are to be implemented. Designing fire scenarios requires a sound knowledge of fire and of the consequences of fire (see section 2.3).

Providing protection against fire can be compared to trading in time as a fire develops. Dividing a certain fire development into phases enables scenarios to be drawn up. The phases denote the maximum performance expressed in time as regards the protection objectives, for example for discovering the fire, alerting, reporting, evacuation and intervention. The method to be applied can be implemented using the information from the conceptual framework for fire prevention from chapter 1.

### Steps 4 and 5

Steps 4 and 5 are about minimising the safety risks to the extent that is reasonably possible by implementing fire protection measures and facilities. Preconditions for steps 4 and 5 are that the envisaged objective and the basic assumptions from the public and private domains are known since they will have to be complied with. In these steps, one or more scenarios are translated into protection options. The key terms for this are mapping, evaluating and verifying. The sequence in which they are listed is theoretical. In practice, they will often not be clearly separated. This is up to the designer.

#### *Mapping*

Mapping involves listing the possible protection options, which the designer thinks are appropriate for the specific characteristics of the building. A choice is made based on the mapping exercise. The next question is whether the solutions that have been devised can actually be integrated. Alternatives may be part of them.

#### *Evaluation*

Evaluation focuses on the protection options identified by mapping and should lead to an opinion about them. This opinion is connected to whether or not a certain measure and/or facility can be applied. Functionality and reliability play a leading role in this opinion.

Functionality is about whether a protection option can deliver the performance required. For example, a specific event may require a smoke and heat ventilation system as a protection option, which serves to improve escape safety. This can be substantiated by means of calculations using models for fire growth, smoke development and evacuation. If functionality is assessed positively, the protection option can be applied, provided that it is sufficiently reliable. If functionality is assessed negatively, adjustments will have to be made, for example adjustments to the protection option chosen or to the specific construction characteristics of the building. Adjusting the fire scenarios is not a solution unless there are good reasons



for doing so. See section 2.4 of this chapter for further information about models. Reliability concerns the proper functioning of protection options and involves the assessment of the probability of failure. If the probability of failure is too great, alternative protection options will have to be considered.

#### *Verification*

The final element of step 5 is verifying the protection options chosen, i.e. deciding whether they can be integrated with the main and sub-objectives of fire prevention. If verification yields a positive result and the residual risk is acceptable, the options should be implemented. A negative verification result indicates that the wrong choices have been made. In that event, another type of protection option must be considered which does lead to a positive result.

#### **Step 6**

When step 5 has been completed, it will be clear which risks relating to the fire protection of a building are under control and what the residual risks are. It should then be decided whether the residual risk can be accepted. If this is not possible, the protection options may have to be adjusted. Areas that require special attention as regards accepting the residual risk are the redundancy of interrelated fire protection options and the interrelations between the building characteristics and the first-line emergency response in the event of a fire: the in-house emergency response organisation. Redundancy implies the total or partial failure of measures and/or facilities. The question is whether there still is a back-up and whether such back-up is acceptable. If not, adjustments will have to be made to the measures and/or facilities.

It is important to the in-house emergency response organisation that the combination of building characteristics and human characteristics is such that the in-house emergency responders can effectively perform their tasks to ensure timely evacuation. This requires clarity as to how evacuation is envisaged and the possibilities of actually implementing it in practice. This area of attention also originates from the consideration of cost effectiveness during a building's life cycle. Once-only investments in protection facilities should be compared to the long-term management costs for the organisation involved in having an in-house emergency response organisation. When considering the long-term management costs for the organisation, the costs of a large or comprehensively equipped in-house emergency response organisation should be compared to those of a smaller and/or less comprehensively equipped in-house emergency response organisation. Better fire protection facilities, for example in the form of automatic fire suppression systems, may contribute to this.

## 2.2 Risk analysis methods as part of risk approach

Risk analysis methods are applied when implementing a risk approach based on the phased plan. The probability-impact matrix and the event tree are useful methods. Both methods are tools that are used in daily implementation practice. The results of using the methods should be documented. The degree to which this is done depends on the project in question and corresponds to its complexity.

### 2.2.1 Probability-impact matrix

The probability-impact matrix method is described in section 6.2 of chapter 5. This method can be applied once or several times in all steps of the risk approach, as part of an iterative process.

What is remarkable is that the parties involved often apply the probability-impact matrix method without realising. Often, the process of considering the risks and taking a decision takes place in the minds of the parties involved, without being put into words. The parties' own perception, prejudices and experiences then form part of it and automatism does its work. The choices made in such cases are definitely not based on a thorough analysis.

### 2.2.2 Event tree

The event tree method is described in section 6.3 of chapter 5. The method can be used when translating the scenarios into protection options (step 4) combined with the risk analysis of the protection options (step 5).

The method's application is limited to complex situations where, for example, several protection options should be compared to each other in order to choose the best possible one. Drawing up several event trees makes this possible. What is inherent in the method is that a risk analysis of parts of a protection option should be performed using the probability-impact matrix method. Assigning failure probabilities is inextricably connected with this.

### 2.2.3 Risk analysis method as part of risk approach

Figure 27 links the probability-impact matrix and the event tree to the six-step risk approach.

An explanation of all steps, except step 1, is provided below the diagram. Step 1 is the step where an assessment is made: no risk analysis methods are applied here.

Risk approach		
Step	Theme	Method
1	Building or part of a building with risk indication	Model for risk indication
2	Probability of fire?	Probability-impact matrix
↓ <b>Output = risk information</b>		
3	Scenario philosophy Determining normative fire scenario(s)	Probability-impact matrix
↓ <b>Output = a (or several) normative fire scenario(s)</b>		
4 and 5	'Translating' scenarios into protection options Risk analysis of protection options	Probability-impact matrix and the Event tree
↓ <b>Output = facilities and measures for fire protection options</b>		
6	Residual risk acceptable?	Probability-impact matrix
<p>Explanation:</p> <p>With step 2: the 'probability-impact matrix' method can be used as a tool to obtain an understanding of the risk of a fire occurring and its consequences.</p> <p>With step 3: the 'probability-impact matrix' method can be used as a tool to draw up a (or several) normative fire scenario(s).</p> <p>With steps 4 and 5: the 'probability-impact matrix' and 'event tree' methods can be used as tools to identify fire protection facilities and measures in the framework of the normative scenarios. Several protection options or variants can play a role here. The 'probability-impact matrix' method can be used as a tool to decide the optimum choice. The 'event tree' method can be used in more complex situations where protection options are compared to each other. The 'probability-impact matrix' method can be used as part of the 'event tree' method.</p> <p>Step 6, which is about accepting the residual risk, can be visualised using the 'probability-impact matrix' model.</p>		

Figure 27 Risk analysis methods linked to a phased risk approach plan

## 2.3 Fire scenarios

In FSE solutions, fire scenarios serve as the principle for fire protection. A fire scenario provides an understanding of the development, the size and the consequences of a fire. A fire scenario is defined as follows:

'A fire scenario is a theoretical description of a realistically imaginable fire based on some pre-selected factors that determine the growth and the development of a fire (and smoke), the output of which is the impact of such fire for the people in the building, the fixtures and fittings of the building and the actual building'.

Due to the many factors that may determine the occurrence and development of a fire, many different fire scenarios can be drawn up, but only the scenarios with considerable consequences are relevant. The relevance of a fire scenario is closely related to the decision taken in step 2 (see section 2.1 Six-step risk approach).

Fire scenarios can be translated into protection options by linking a certain fire development to its consequences. The main consequences relate to the following and other factors:

- people evacuating the building
- intervention by the in-house emergency responders
- intervention by the fire service
- construction
- damage.

It is evident that the spread of fire and smoke form part of this.

Translating fire scenarios into protection options is actually about being ahead of the threats of fire and beating them by a safe margin. People's behaviour, especially while evacuating an area, must be taken into account in this.

### 2.3.1 Fire as part of the scenario

A certain reference fire must be the point of departure when deciding which fire protection measures and facilities to apply. In the context of FSE solutions, the concept of natural fire design and 'fire models' is used for this. These models are about a more realistic approach to fire development than is the case when using the standard fire curve as prescribed by the prevailing building regulations (see section 2.4 for information about fire models).

### 2.3.2 Evacuation as part of the scenario

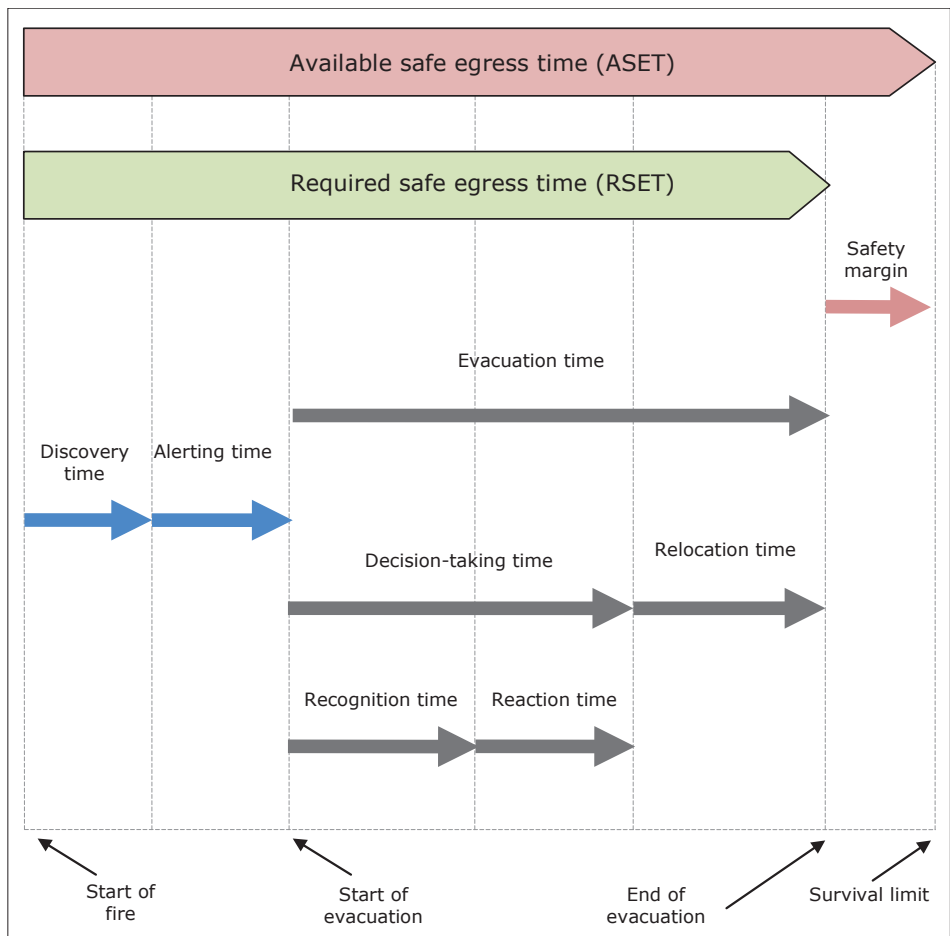
During a fire situation, sufficient time will have to be available for people to flee safely. This time is also referred to as the 'evacuation time'. People must be able to reach safety in good time. The available safe egress time (ASET) must be compared to the required safe egress time (RSET). A sufficient safety margin has to be taken into account as well. The required safe egress time and the margin must be shorter than the time that elapses before the fire has developed into a life-threatening situation.

Aspects that play a role in fleeing are the speed of fire growth and smoke development compared to people's speed. The process of fleeing consists of three basic activities that are carried out in sequence:

1. becoming aware of danger due to external stimuli
2. validating such danger signals and reacting to them (decision-taking)
3. moving to a safe location.

Activities 1 and 2 combined are the decision-taking time. Activity 3 is the relocation time.

Figure 28 shows the timeline for evacuation. This timeline can be used as part of a scenario. It can be used in order to provide the right fire safety measures and facilities that serve evacuation.



**Figure 28** Timeline for evacuation

The available safe egress time (ASET) is the period between the start of a fire and the moment that ambient conditions are such that people can barely survive. The possibility of escaping is adversely affected during the available safe egress time. In order to determine the available safe egress time, analyses have to be carried out of factors that lower the chance of survival. Examples of these factors are the time until a layer of smoke has reached a certain height and the time until the heat and the concentration of hazardous materials released in a fire are such that people succumb.

The required safe egress time (RSET) is the period between the moment a fire starts and the moment when people reach a safe location. After the alerting time, the required safe egress time is determined by the sum of the time needed to take a decision (recognition and reaction time) and the time needed to relocate the people. Evacuation must take place before ambient conditions become fatal.

## 2.4 FSE tools

There are many documents and models available for designing and implementing fire safety in buildings using FSE techniques. These documents and models are referred to as FSE tools. The Dutch Building Decree, for example, can be used as a reference model for FSE solutions. This also applies to standards, determination and calculation methods, design guidelines and certain parts of this document.

Special models that are applied in the context of FSE are fire and evacuation models, models for the activation times of fire detection elements, and models that enable the fire resistance of building structures, until failure, to be determined. These models are also referred to as simulation models. In general, the use of these models is computer assisted. This is due to the complexity of the physical and statistical relationships that can be parameters in the models. Fire models are largely inspired by the principles of fluid mechanics. Fluid mechanics are about the conservation laws for conservation of mass, conservation of energy and conservation of momentum. For fire modelling, this is complemented by the conservation of chemical elements in connection with the conversion process, the combustion. There are relatively many models in this category of models. They have mainly been developed in countries other than the Netherlands.

Models serve as aids to reach a certain objective and they have a particular application within a given scope. When using a model, its objective and scope have to be considered and related to the envisaged objective of fire protection. Incorrect use of models may result in unsafe situations. Randomly and inexpertly shopping around in the many models that are available is also a form of incorrect use.

Save for the escape safety analysis model, this document does not go into the specific characteristics of a certain model since the number of existing models is simply too large and diverse for them to be discussed here. This would also require a substantial research effort. However, descriptions have been provided for a number of main aspects that play a role in the models.

When using models, it must always be noted that the models are no more than simplified representations of reality. Models have no predictive value and their results carry attendant uncertainties. They are not soothsayers. Even the most sophisticated model will always provide a simplified and limited picture. However, what a model can do is provide an understanding of the development of fire and smoke, for example in connection with evacuation and/or a structure's resistance to fire. This understanding is better than the current, common understanding that is based on general rules. This means that FSE can ensure a better understanding, enabling better decision-taking and resulting in fire safety that is attuned to the risks. A precondition is that this is applied by experts who have undergone the specific education required.



### 2.4.1 Fire models

Fire models enable calculations to be made on how a fire develops. There are two main groups of fire modelling: traditional and innovative models (see Figure 29 for the classification of fire models). The normative factor in the traditional method is the temperature/time development of the standard fire curve, whereas the innovative method is based on natural fires. The innovative method is relevant to FSE. The method is dynamic. A fire development with heat release rate scenarios is applied to natural fires. The energy (heat and smoke) of a natural fire is characterised in terms of the heat release rate density (in  $W/m^2$ ) and time constant (in sec). Between these two main groups, there is an intermediate area of semi-innovative or simple fire models. An example of such a model is the model used to assess fire spread through the air, as stated in the prevailing building regulations. The innovative fire models are sophisticated models and can be broken down into zone models and field models.

Fire models	
Traditional	Standard fire model or standard fire curve *)
Innovative	Sophisticated fire models or natural fires. <ul style="list-style-type: none"> <li>• Zone models               <ul style="list-style-type: none"> <li>• single-zone model</li> <li>• two-zone model</li> </ul> </li> <li>• Field models</li> </ul>

\*) but also: external fire curve and hydrocarbon curve

**Figure 29** Main groups of fire models

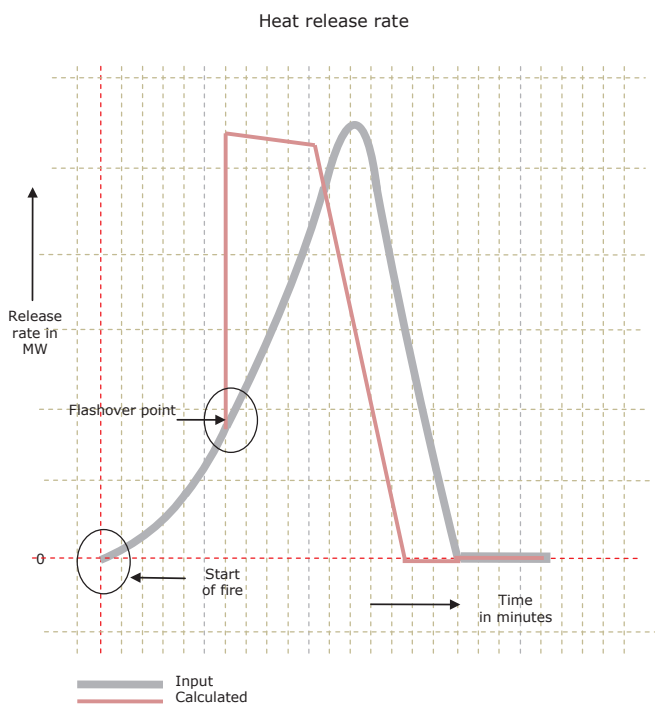
#### Innovative fire models

Innovative fire models take a more realistic approach to fire development than the traditional method. The growth and decay phases form part of this development. The phase preceding the moment of flashover is the most important phase for safety, specifically as regards people, including fire service personnel. Intervening in the fire, for example by extinguishing it and/or influencing the moment of flashover by means of active fire protection facilities, such as automatic suppression and/or smoke and heat ventilation is the most effective during this phase. An assessment of the probability of flashover occurring can be provided using models that are capable of calculating the fire development in a certain environment.

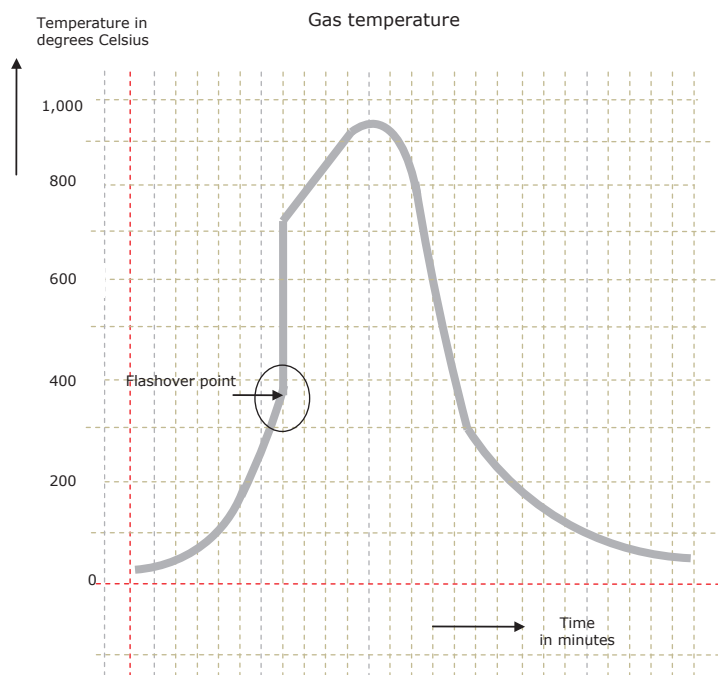
Figures 30 and 31 represent a natural fire development based on the heat release rate of a particular fire. Figure 30 shows the heat release rate (in MW) compared with the time (in minutes) and figure 31 shows the gas temperature (in degrees Celsius) compared with the time (in minutes).

Innovative fire models include calculation rules, for example calculation rules that enable information to be provided about the ambient conditions caused by a fire in a room (compartment). This might include the temperature and density of the smoke and the thickness of a layer of

smoke. 'More realistic' refers to the dynamic nature of the models. The calculations can be done in time steps, with the ambient conditions of the fire characteristic, and the smoke and temperature development becoming known for each time step. The interaction between the fire characteristics and the building characteristics plays a role in these calculations. The fire characteristics - the degree of smoke spread and heat transfer by conduction, convection and radiation - are compared to the surrounding rooms. Examples of factors that play a role in this are the geometry of the room with the fire, obstacles in the room, the openings in the room (such as windows, doors and ventilation openings), the fire properties of the materials of the envelope around the room with the fire (especially walls and ceilings), conduction by the envelope around the room with the fire and the roughness of the wall surfaces.



**Figure 30** Heat release rate (MW) set out against time (in minutes)



**Figure 31** Gas temperature (degrees Celsius) set out against time (in minutes)

The models enable calculations to be made to gain information about heat and smoke conditions and to thus determine whether the escape safety and the structural safety are sufficient or need optimising. Besides escape safety and structural safety, private goals, e.g. safety to prevent damage or loss, can also play a role. The innovative models, also called 'dynamic fire models' are the zone models and the field models.

Fire and smoke behaviour play a crucial role in all models. Characteristic parts of the fire models are:

- the fire characteristic
- the smoke
- the plume model
- the type of fire: fuel-controlled or ventilation-controlled.

The parts of the models are sub-parts of a fire model.

#### 2.4.1.1 Fire characteristic

Determining the fire characteristic, the source of the risk, and then linking this to a certain type of building, is a crucial element of FSE. The deterministic as well as the statistical methods can be used to determine the fire characteristic. The basis assumption for both methods is fire load, which is converted into a heat release rate scenario. Calculations resulting in a specific bespoke solution play a role in the first method. The second method makes use of a statistical approach, assuming a classification of fire load into types of buildings. This latter method is used the most in practice. It makes use of a classification of heat release rate density and fire spread speed and its correlation to a type of building. Please see figures 32 and 33 for an indicative classification. This classification is based on reports, publications and standardisation. Examples of such documents are:

- Report: *Richtlijn Vultijdenmodel grote brandcompartiment* (Guideline on Large fire compartment filling time model) – parts 1 and 2 / 96-CVB-R0330 (1 and 2) / TNO Centre for Fire Safety / 1996
- Report: Valorisation project - Natural fire safety concept / European project in which TNO was involved / 1999
- Publication: *Doelstellingen brandveiligheid grote brandcompartimenten* (Fire safety objectives of large fire compartments) / Dutch Ministry of Housing, Spatial Planning and the Environment / 2008
- National annex to Eurocode NEN-EN 1991-1-2+C1 / Eurocode 1: actions on structures / 2011

#### *Heat release rate density*

The heat release rate density is expressed in a limited number of reference heat release rate densities. The heat release rate density indicates the amount of available energy per m<sup>2</sup> and is divided into classes. The heat release rate density equals the amount of heat released per surface unit (m<sup>2</sup>) as soon as the fire has fully developed in a certain location. The heat release rate density is considered to be a constant value. See figure 32 for a classification of reference heat release rate densities.

Reference heat release rate density	
Ref. heat release rate density [kW/m <sup>2</sup> ] *)	Class
250	Normal
500	High
Multiple of 500	Very high

\*) the heat release rate density equals the amount of heat released per surface unit (m<sup>2</sup>) as soon as the fire has fully developed in a certain location.

**Figure 32** Classification of reference heat release rate densities

### Speed of fire spread

If a fire develops fast, the energy is released in a shorter time than if a fire develops slowly. This gives a rapid fire a different temperature development than that of a slow fire. The temperature development of a fire of a similar type and amount of wood, that may or may not have been shredded, is used as an example here. If sufficient oxygen is present, the amount of energy will be released in a shorter time than would be the case if a timber beam were burning. The impact in that shorter time will be greater. See figure 33 for a classification into fire spread speeds. The higher the value of the time constant, the lower the speed of fire spread, i.e. the lower the heat release rate.

Fire spread	
Speed of fire spread	Time constant in seconds *)
Slow	600
Moderate	300
Fast	150
Super fast	75

\*) the time in seconds that is necessary to reach the heat release rate density of 1 MW.

**Figure 33** Classification into fire spread speeds

### Linking the fire characteristic to a building

Linking the fire characteristic to a type of building or a part thereof is an important next step. The question to be asked and answered is: which fire characteristic applies to which type of building (or part of a building)? This information can be classified as shown in the diagram in figure 34.

Type of building *)	Reference heat release rate		Fire spread	
	kW/m <sup>2</sup>	Class	Speed	Time constant
... building	250	normal	moderate	300
... building	500	high	fast	150
... building	...	...	...	...
etc.	etc.	etc.	etc.	etc.

\*) add expansions as subdivision into building types

**Figure 34** Diagram of fire characteristic information

As a minimum, the reports, publication and standardisation referred to above are available for assigning fire characteristics to a certain building type in practice. To illustrate this: as regards their reference heat release rate densities, an office building and a hospital are classified as normal (250 kW/m<sup>2</sup>) and a theatre as high (500 kW/m<sup>2</sup>). The moderate class of fire spread (a time constant of 300 sec.) applies to an office building and a hospital, whereas the fast class (a time constant of 150 sec.) applies to a theatre.

#### 2.4.1.2 Influencing the fire characteristic

Automatically suppressing a fire enables the normative fire scenario to be scaled down compared to a scenario that does not provide for automatic suppression. If a properly designed and maintained sprinkler system is used, a pre-defined smaller fire size that contributes to better circumstances as regards aspects of time, temperature and smoke can be taken into account. This optimises the safety of people and of the building structure, since small fires have less significant consequences than large fires.

#### 2.4.1.3 Smoke

Smoke is the aggregate of solid, liquid and gaseous combustion products. The plume rise of a fire may lead to the chimney effect. The hot air, the smoke, of the fire rises up and cools down and deposits as it rises up further. This creates a vertical air flow. If the hot and cold air columns are connected with each other at their bottoms and tops, hot air will flow into the cold air column at the top and cold air will flow into the hot air column at the bottom. This air column is combined with the ambient air (if available) that is contained in the flow of the combustion products. The air that is mixed in is a constituent of the smoke. The difference between combustion products and the air that is mixed in cannot be discerned anywhere. Mixing in ambient air permanently increases the amount of the smoke flow (mass flow rate). It should be noted that, if the smoke poses a hazard which involves risks, protection measures can be taken, for example by diverting the heat and smoke.



Listed building

### **Barriers**

Barriers in the air flow negatively affect the plume rise: there will be more smoke. The most 'ideal' location of a fire is in the centre of the room (for example in an atrium) where the plume rise is not hindered. In reality, there is often no 'ideal' location. The longer the distance travelled by the air flow, and the smoke flow, the greater the mass flow rate of the smoke flow will become due to ambient air being mixed in. This takes place for example in the event of a fire:

- in a room adjacent to the room through which the flow of smoke has to be discharged, and/or
- where the flow of smoke is hindered by such barriers as landings and mezzanine floors; for example smoke rotating on landings.

### **Risks of smoke**

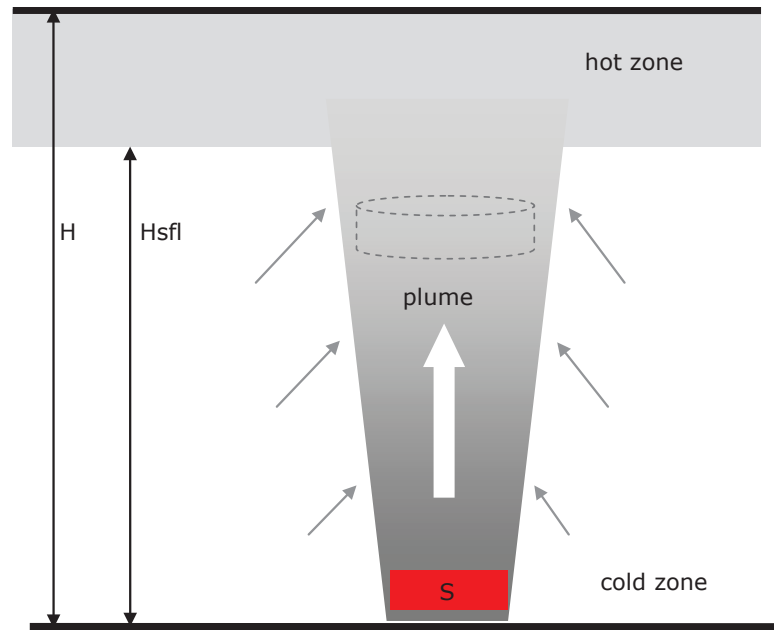
Smoke involves risks. It may threaten the people in the building and the building as such. The threats of smoke are due to:

- exposure to hot gases and heat radiation
- exposure to toxic gases
- loss of sight.

Exposure to hot gases and heat radiation may have consequences for both a building and for its occupants. The risks of toxic gases and loss of sight affect people. Toxic gases may lead to dysfunction and eye irritation, reducing distance vision. The risk of smoke is also due to smoke particles that are created in a fire. They are solid particles: ash, and liquid particles: condensate. There is a relationship between these particles and distance vision, as this is influenced by light absorption and light scattering by these particles and by the irritation effect that the particles have on the eyes. Decreasing distance vision negatively affects escape safety.

#### **2.4.1.4 Plume model**

A fire in a room creates a plume. The plume is the vehicle that transports heat and combustion products. A vertical air flow (plume rise) is created by the difference in density of hot and cold air. Transport of energy occurs under the influence of the plume. The size of the plume depends on the extent of the fire. The plume of smoke increases in size as it is able to rise higher. Figure 35 shows a diagram of the plume model.



H : room height  
 Hsfl: height of smoke-free layer  
 S : seat of the fire

**Figure 35** Diagram of smoke plume

#### 2.4.1.5 Type of fire: fuel-controlled – ventilation-controlled

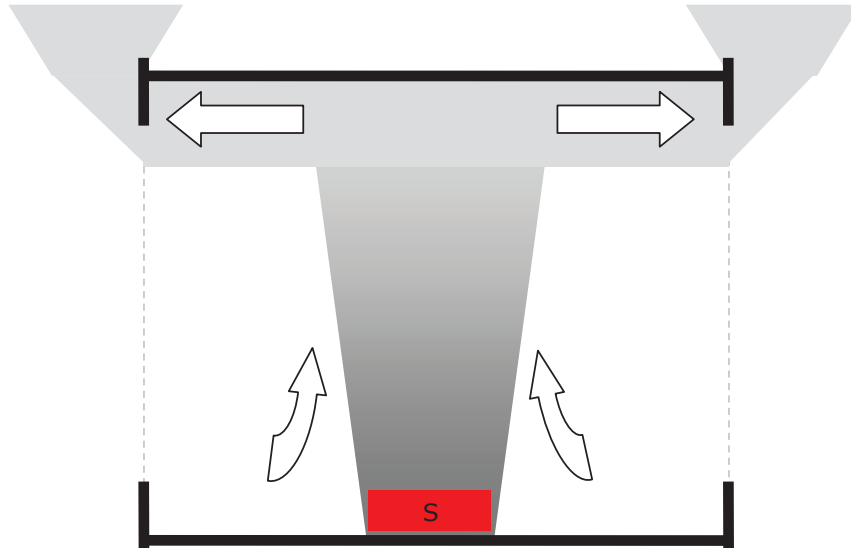
A fire in a room can be broken down into a fuel-controlled fire and a ventilation-controlled fire. The ventilation-controlled fire is also referred to as an oxygen-controlled fire.

The distinction is important since the type of fire influences the ambient conditions (and, as a result, the safety) in a room. The type of fire can be calculated. Important factors here are the openings in the room with the fire and the room's ventilation. Actually, these factors can be influenced, for example by removing smoke and heat. There is a much harder to define intermediate area between a fuel-controlled and a ventilation-controlled fire. This area is important for the possible occurrence of flashover. During the first phase, the growth phase of a fire, the fire is still a local fire. It has not fully developed yet and no flashover has taken place.

##### **Fuel-controlled**

A fuel-controlled fire is a fire where conditions are such that sufficient oxygen is supplied to maintain full combustion. Supplying more oxygen does not have any consequences for the fire. The heat release rate and the size remain the same. Figure 36 provides a diagram of a fuel-controlled fire.

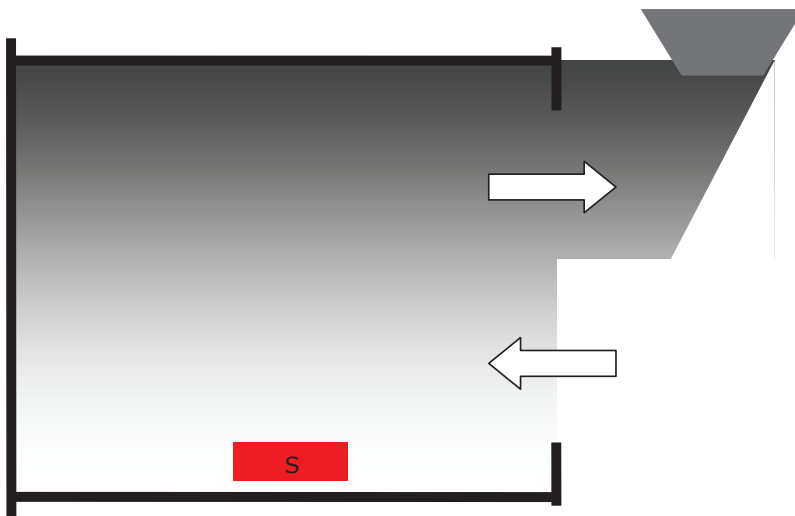




**Figure 36** Diagram of a fuel-controlled fire

### Ventilation-controlled

A ventilation-controlled fire is a fire where conditions are such that the size and the heat release rate of the fire are determined by the amount of oxygen that is supplied. The amount of fuel and the size of the room are not the determining factors in this case. Figure 37 provides a diagram of a ventilation-controlled fire.



**Figure 37** Diagram of a ventilation-controlled fire

### Intermediate area

There is a hard to define intermediate area between both types of fire. Initially, a fire in a room is fuel-controlled. After the fire has developed further, a situation may occur where:

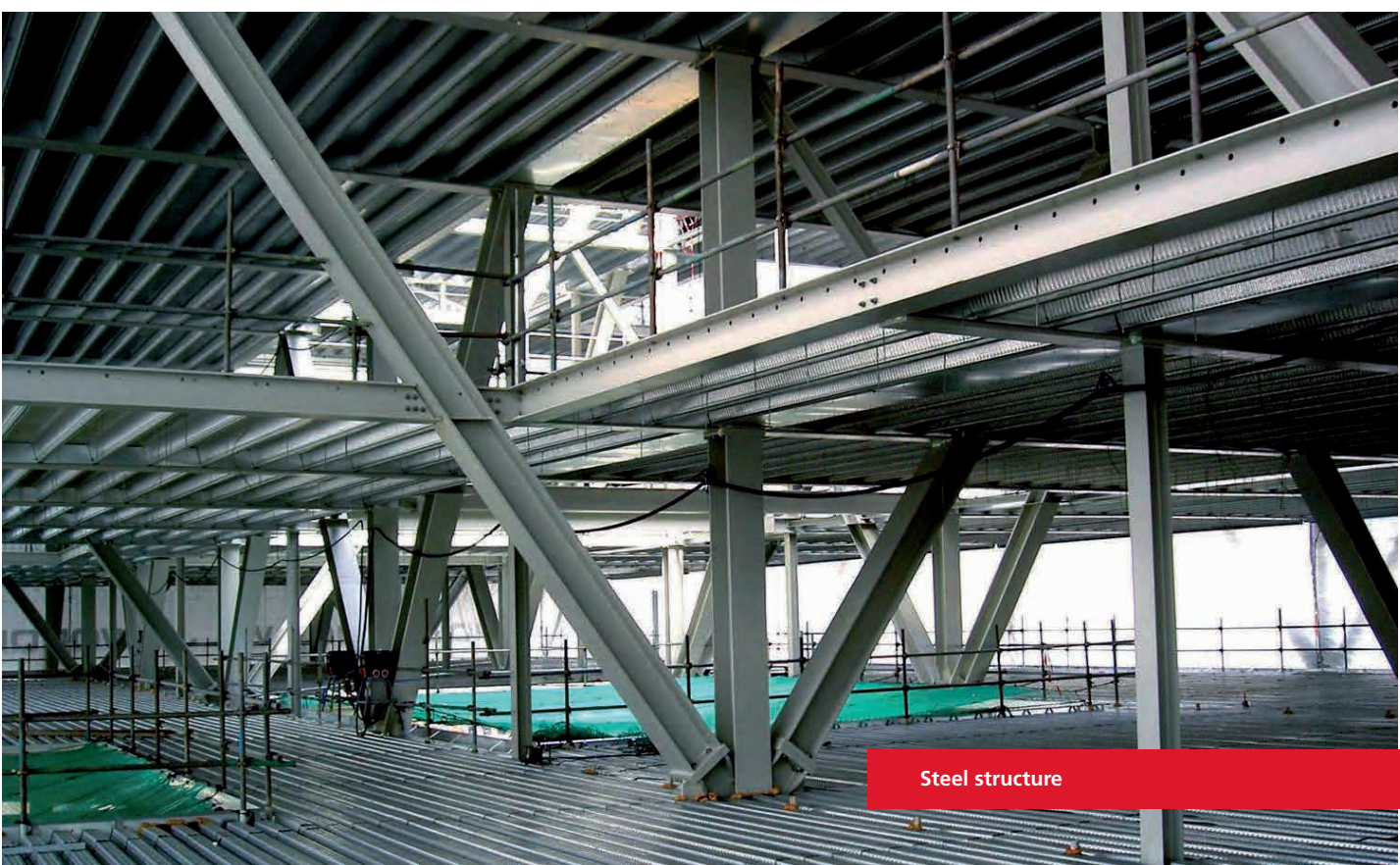
- a lack of a supply of oxygen prevents the fire from growing. The fire is ventilation-controlled in that case and, if the circumstances do not change, it will not grow any further
- sufficient oxygen continues to be supplied. The fire does not become ventilation-controlled, but neither does it continue to be fuel-controlled since all fuel contributes to the fire

- the temperature of the smoke of the fire has become so high that the hot smoke layer that has developed will cause flashover in the room. This results in the fire spreading to objects in the room very fast, without these objects coming into contact with flames. Ignition takes place under the influence of radiation of the flames and the layer of smoke. The fire is not fuel-controlled then either. In many situations, the fire will become ventilation-controlled due to flashover, assuming equal conditions.

#### 2.4.2 Innovative fire models

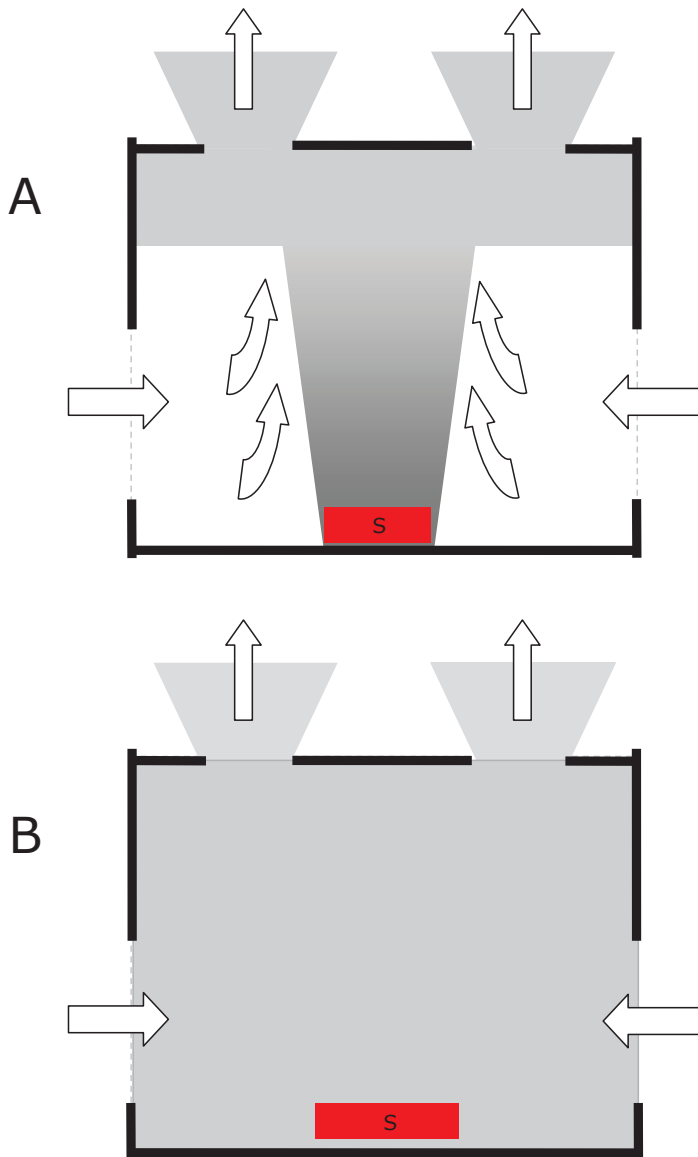
Innovative fire models can be broken down into zone and field models. The basic philosophy underlying these models is to relate the amount of energy that is released per time unit of a fire to the possible consequences for the people and the building. The models make it possible to carry out calculations where both the fire and the room are taken into consideration. Variables such as the geometry of the room, the choice of materials and the size of the fire form part of this.

The smoke-free zone, the temperature and whether or not flashover occurs are crucial elements of these calculations. The basic assumption is that, when the fire starts, there is a local fire in the room and this fire grows steadily. There is a relationship between this steady growth and the fire characteristic (see section 2.4.1.1). The growth phase of a fire stops at some time and then makes the transition to a phase where the burn-down speed is at its maximum level. This is the stationary phase. The results of the calculations can be used to assess whether flashover will take place. The basic idea is that the smoke-free layer should be sufficient and that no flashover should occur. The fire models provide an understanding of the fire development in a specific circumstance and thus enable optimum protection choices to be made.



### 2.4.2.1 Single-zone models and two-zone models

In a single-zone model, the temperature is spread homogeneously through the room. A two-zone model is based on the assumption of stratification by a horizontal separation between a hot zone, the smoke layer, and a cold zone, the smoke-free layer. As the fire develops further, the smoke layer will become thicker and the temperature in the smoke layer will rise. The smoke-free zone becomes smaller. If conditions are such that flashover occurs, the single-zone model (A) will make the transition into a single-zone model (B). The plume model no longer plays a role here. A diagram of a single and two-zone model is provided in Figure 38.



**Figure 38A** Diagram of a two-zone model

**Figure 38B** Diagram of a single-zone model

#### 2.4.2.2 Field models

Field models are the most sophisticated models. The method applied to field models is also used in other disciplines, for example in ventilation engineering. A field model enables a room to be divided into a large number of calculation cells: volume elements. It is a three dimensional calculation model. The heat and smoke conditions for every calculation cell can be calculated. Besides temperature distribution, other properties, such as heat flow, can also be highlighted. Objects in buildings and architectural or structural elements of buildings that affect the flow, can be incorporated into the calculations. The level of detail required for documenting the geometry of the room depends on how much accuracy is necessary. If the geometry is described in great detail, this requires a lot of computing power from the computer. Ideally, the geometry details that are input as part of the field model should be kept as simple as possible without allowing relevant information to be lost.

To be able to do the calculations, the geometric model must be divided into a calculation grid constructed of calculation cells. A fine-meshed grid results in a greater number of cells and more accurate results. However, more calculation cells also means a longer calculation time.

#### *Consideration of innovative fire models*

The use of innovative fire models is based on zone modelling, as this method produces good results in many situations. And this method is easier, less extensive and, as a result, cheaper than field modelling. Field modelling should only start playing a role if zone modelling does not suffice, for example if necessitated by the geometry of the room within this calculation domain. Examples of this might be complex configurations of buildings or tunnels in combination with (underground) stations.

#### 2.4.3 Evacuation models

Evacuation models are about determining whether people can leave a room or a building in good time. These models are used for design or verification purposes. For classification purposes, a division has been made between evacuation models in general and the escape safety analysis model in particular. The reason for this is that people's behaviour in a fire has already been taken into consideration in the escape safety analysis model.

##### 2.4.3.1 Evacuation models

Evacuation models enable the evacuation time of buildings to be calculated. They can show the bottlenecks, if any, and can be used for design and verification purposes. Evacuation models are related to the timeline for evacuation (see section 2.3.2). The required safe egress time must always be shorter than the period between the start of the fire and the available safe egress time. In other words: required safe egress time < available safe egress time. An important element of evacuation models is the flow or circulation capacity of the escape routes due to the relationship between the number

of people and their individual speeds, the interaction between people and the interaction between people and the environment. In general, evacuation models consist of a geometric part and a physical part.

### **Geometric part**

The geometry of a building or a room largely determines how evacuation will take place. To be able to do a calculation with an evacuation model, architectural information about the building has to be entered into the model. Examples of such information are floor plans, the opening directions of doors, dimensions of door openings, corridors and stairs.

### **Physical part**

The physical part of the calculation model contains the physical circumstances and characteristics of people. This should at least include the occupancy (number of people/m<sup>2</sup>) and the composition of a group of people based on the sizes of their bodies (adult man or woman, or child).

Sophisticated evacuation models can provide more information, such as the influence of walking speed in relation to the ages, genders and activities of the people in a group. An activity may for example be defined as 'shopping'. Some evacuation models can present graphic visualisations on a monitor of the movements and flows of people who are fleeing from a building. Evacuation models are sometimes linked to innovative fire models.

#### **2.4.3.2 Analysis model for escape safety**

The degree to which people are able to leave a building where there is a fire is determined by three aspects, i.e. the fire characteristics, the building characteristics and the human characteristics. Escaping is an expression of the behaviour of people who are able to leave without assistance, in the event of a fire. This implies that the degree of escape safety of a building depends on the aspects stated. For every aspect, there are critical factors that affect escape safety. These critical factors have been gathered together in a model, i.e. in the analysis model for escape safety. The model is based on findings from a literature review into the fire safety of buildings and human behaviour in the event of a fire.

The goal of using the escape safety analysis model is to systematically analyse the critical aspects of escape safety in a building. The model offers an analysis framework in which all aspects that may influence people's behaviour in a fire are addressed. Aspects that negatively affect people's ability to leave without assistance can then be analysed further in order to draw up recommendations for improving escape safety in the building.

The escape safety analysis model can be used in order to systematically analyse the critical aspects of escape safety in:

- new build (building design phase)
- an existing building (occupancy phase of a building)
- an existing building where there has been a fire (fire evaluation phase).

The unabridged version of the escape safety analysis model is provided in annex B. See figure 39 for a diagram of the model.

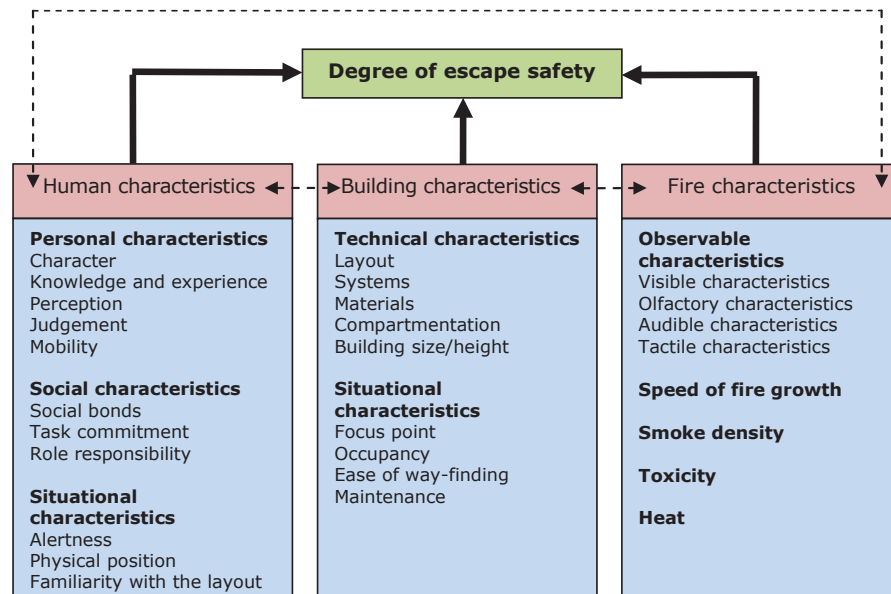


Figure 39 Diagram of escape safety analysis model

#### 2.4.4 Models for fire detection element activation times

Models for the activation times of fire detection elements are about calculating the response times of automatic fire detection equipment, such as automatic fire detectors and the thermal elements of sprinklers. There is often a relationship between the fire detection elements and the operation of fire protection systems, including the smoke and heat ventilation system. The models are combined with innovative fire models due to their relationship with smoke spread and heat transport.

#### 2.4.5 Models for structural safety (fire resistance until structural failure)

Buildings must comply with requirements of structural safety to a certain degree. This initially concerns requirements for fundamental load combinations. The objective of these requirements is that these load combinations cannot lead to a building structure failing while it is being used for its intended purpose. For the load combinations, there is a distinction between permanent loads, for example the structure's own weight, and variable loads, for example those of the fixtures and fittings, including machines, and people. Requirements for extraordinary

combinations of loads also apply. The basic assumption is that a building structure to which a direct load is applied may fail as long as this does not lead to the failure of other building structures than those in its direct vicinity. If part of a construction fails, construction parts in its direct vicinity may fail. However, this must not happen to building structures that are located further away, as this might lead to progressive failure of the structure. Examples of extraordinary combinations of loads are impact loads exerted by vehicles, trains and ships, loads due to internal gas explosions, loads due to an extreme rise in ground water or other water levels, the effect of storm when windows and doors are open and another building's stability facility having been lost.

In addition to fundamental and extraordinary load combinations, buildings and certain escape routes must also be protected against the danger of collapsing due to fire. There are models for this as well. These models also provide additional calculations for fire resistance until parts of structures fail. Examples of this are the fire resistance of, for example, steel or concrete pillars and girders. A precondition for using these models is that sufficient knowledge of construction science is available, provided by a design engineer.

Note:

In the context of European harmonisation, structural safety is covered by European standards: the 'Eurocodes'. They have been published in the Netherlands as NEN 1990 '*Grondslagen van het constructief ontwerp*' (Basis of structural design) and further standards in the NEN-EN 1990 to NEN-EN 1999 series. National annexes are linked to the European standard. Eurocode 1 (NEN-EN 1991-1-2) prescribes the thermal load in combination with mechanical load for strength in the event of fire. NEN-EN 1991-1-2 offers the possibility of using several fire models, including models based on the innovative method of natural fires (natural fire design). NEN 6055 '*Fysisch brandmodel op basis van een natuurlijk brandconcept*' (Physical fire model based on a natural fire concept) is the standard that has been developed for this for the Dutch situation. The national annex NEN-EN 1991-1-2/NB provides information about fire characteristics as the input for the fire model and contains a risk approach for the structural safety.

### 2.4.6 Consideration of FSE tools and recommendations

The special category of models applied to FSE contains fire and evacuation models, models for fire detection element activation times and models for structural safety. These models are mainly developed in countries other than the Netherlands; there are relatively many of them. For the purposes of applying these models to the Dutch situation, research is recommended in order to improve national uniformity. The results of this research will enable parties involved from the market and government sectors to make better choices than is currently possible, i.e. choices that are more distinctly based on the risk.

This research includes:

- aspects for the fire and evacuation models and models for fire detection elements:
  - reaching decisions as to which models can best be applied in a given situation
  - being able to determine the best input for fire characteristics for a given situation.
- aspects for structural safety:
  - being able to determine the best input for fire characteristics for a given situation
  - studying whether the risk approach complies with the fire service's options in terms of repressive action, in the light of developments in the context of the 'Fire Service for Tomorrow'.

## 3. Process and method

As is the case with an assessment of equivalence, the working method for FSE requires a good process. The key terms are objectiveness, transparency and understandability. A precondition is good interaction, both as regards communication and reporting, between the market and the government. In order to make sure that the processes run smoothly, it is important that parties make agreements. This has been outlined in this section, with the process and the working method for reports serving as the central elements. A good process improves the quality of the prevention result and prevents the negative consequences of a possible delay, unnecessary costs and substandard fire protection.

### 3.1 Process model

A distinction is made between three parallel processes in the process model:

- the design and building process
- the process of informal discussions between the applicant and the authority that decides whether or not to grant planning permission
- the formal planning permission procedure.

Figure 40 shows a diagram of these processes, their interrelations and the corresponding reports. The design process and the building process are controlled by the person taking the initiative, the initiator.



### 3.1.1 Informal discussions on the approach to equivalent safety

Informal discussions are held between the initiator or the parties who develop the protection concept on the initiator's behalf on the one hand, and the government and the fire service, on the other. The objective of these discussions is to reach agreement on the practical details and an efficient process in the interaction between the applicant and the authority granting planning permission. The topics may be a quick scan, a risk analysis, an assessment and an evaluation of protection options and the eventual final report. Recording the results of these informal discussions is recommended.

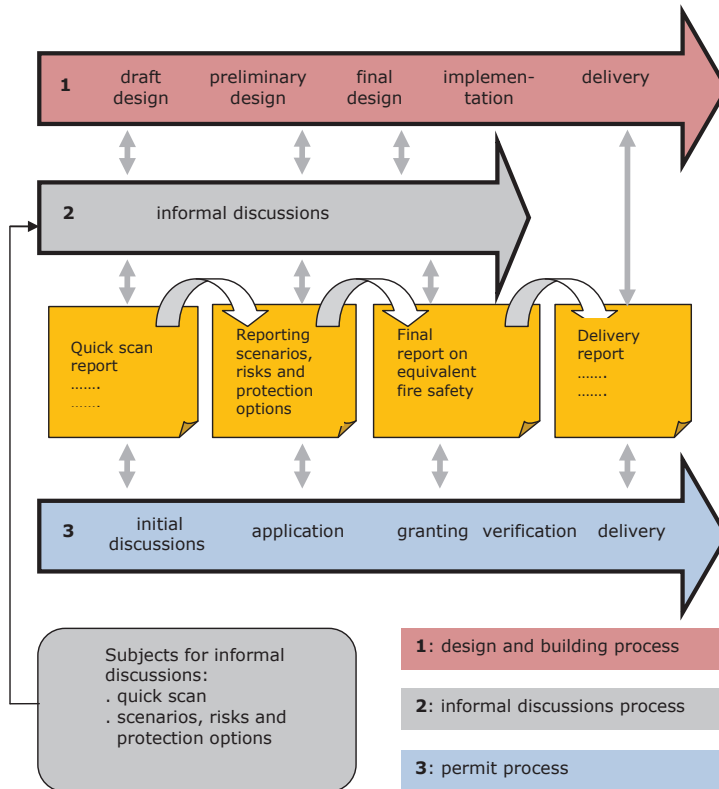


Figure 40 Diagram of a process model

### 3.1.2 Formal procedure

The formal procedure is the procedure for applying for planning permission and the decision that follows. The government's role is that of assessor. The government's advisers, including the fire service, verify whether the equivalent fire safety level has been demonstrated.

### 3.1.3 Interaction: informal discussions – formal procedures

Coordination between parties is not a statutory requirement of the formal procedure, but is highly desirable. Implementing this improves process efficiency as is expressed in procedures and results. In a material sense, this means holding informal discussions at crucial moments and making agreements. Good timing is a precondition. There is little sense in waiting until the last phase of the design stage or the implementation phase before considering the degree and implementation of the fire protection. The early design phase is the most convenient moment to start this. What actually matters is that the parties make good agreements about the process

and the substance. These agreements must be such that authorities and responsibilities are clear. The basic principle is that the market designs and the government assesses. An important precondition is that there is agreement as to the scenarios. The fire service prefers the occupants to be involved in this, since there are often situations where protection solutions that have been devised by technical engineers limit occupants in ways they do not want. An example of this would be a building with an atrium where a fire load in the atrium has not been taken into account for the design and implementation and the occupants would like to use the atrium for purposes that involve a substantial fire load. Such use would not be possible unless adjustments are made.

The initiator draws up some reports and submits them as input for discussions. They are:

- a quick scan report
- a report on scenarios, risk analysis and protection options
- a final report on equivalent fire safety.

The reports follow a logical and efficient path, as they follow naturally from each other. Efforts for the quick scan are necessary for the report on scenarios, risk analysis and protection options and afterwards for the final report.

### 3.1.3.1 Quick scan report

A quick scan report is about the necessity of invoking equivalence. Actually, this is a summary of special characteristics or the bottlenecks that indicate where threshold values are being exceeded. These are the threshold values of the scope of the Dutch Building Decree and the threshold values of the rules within that scope. Examples of special characteristics are underground and high buildings that are not covered by the scope of the Dutch Building Decree, possibly combined with large fire compartments, long walking distances, high occupancy, disproportionate occupancy, large covered inner areas and special use. A risk indication also forms part of a quick scan. The contents of a quick scan largely match information that has been compiled in step 1 of the six-step risk approach. The scope of the report is limited and can be considered a gateway to the report on scenarios, risk analysis and protection options. The quick scan report can be combined with it as well. Drawing up a quick scan report leads to a picture of the fire safety and the associated risks. Agreements about the processes to be followed for the relevant procedures can also be made in this phase.

Figure 41 shows a diagram explaining the quick scan.

Quick scan report	
Initiator	Architect, consultancy firm, fire service
Objective	<ol style="list-style-type: none"> <li>1. Identifying the bottlenecks of the design. Why is the equivalence principle invoked?</li> <li>2. Performing a risk indication</li> <li>3. Laying down the procedure for assessment during the design process: according to process model or deviating?</li> </ol>
Result	Quick scan report

Figure 41 Diagram explaining the quick scan report

### 3.1.3.2 Report on scenarios, risks and protection options

The basic assumption for the contents of a report on scenarios, risks and protection options is that the occurrence of a fire is probable and that some form of protection against fire will have to be implemented. As a minimum requirement, the subjects addressed discuss the envisaged objective and the basic assumptions of protection, the choice of scenario, the assessment and evaluation and the verification of protection options. A risk assessment of protection options may be part of this. Actually, this is about the initiator demonstrating an equivalent fire safety level. It can be substantiated by such documents as:

- reports by consultancy firms,
- reports by autonomous research institutions,
- reports with scientific research,
- calculations with FSE tools,
- the prevailing statutory schemes, including the Dutch Building Decree, as a reference.

The contents of the report on scenarios, risks and protection options are based on the information gathered in steps 2 to 6 of the six-step risk approach. This involves mapping, evaluating, verifying and accepting. A condition for the reports is that they must be easy to understand. Figure 42 shows a summary of the report on scenarios, risks and protection options.



Report on scenarios, risks and protection options	
Person taking the initiative	Architect, consultancy firm To be consulted: fire service (several times if relevant)
Objective	<ol style="list-style-type: none"> <li>1. Defining objectives and basic assumptions</li> <li>2. Determining and adopting scenarios (a risk assessment forms part of this)</li> <li>3. Mapping the protection options *)</li> <li>4. Evaluating the protection options *)</li> <li>5. Adopting the protection options*)</li> <li>6. Verifying protection options *)</li> <li>7. Accepting residual risks</li> </ol> <p>*) Risk assessment of protection options forms part of it. Important elements are the timelines for evacuation in relation to fire development and intervention.</p>
Result	Reporting on the protection options and the route (detailed methods) taken to arrive at the choice of those items defined and/or adopted. The subjects described in the context of the objective shall at least be included in the report. It must be clear how they have been used and the documentation should be easy to understand.

**Figure 42** Summary of report on scenarios, risks and protection options

### 3.1.3.3 Final report on equivalent fire safety

The final report can be drawn up upon completing the verification and acceptance of the residual risk. The contents of this report are obtained from the prior quick scan report and the report on scenarios, risks and protection options. Figure 43 presents a summary of the final report.

Equivalent fire safety report (final)	
Initiator	Applicant
Objective	To be enclosed with permit application
Result	Final report on equivalent fire safety. For content, see also report on scenarios, risks and protection options

**Figure 43** Summary of report on equivalent fire safety

## 3.2 Anchoring in formal permit procedure

The formal procedure starts when the planning application is filed. To be able to file an adequate application, the applicant needs to become acquainted with the statutory filing requirements. When filing for planning permission, the initiator submits documents that have resulted from the design process and the informal discussions. Actually, they are the outcomes of the quick scan report and the report on scenarios, risks and protection options that have been incorporated into the final rapport. The final report on equivalent fire safety is part of the filing documents. The authorities then have to form an opinion on the application, based on the details that have been submitted. Certification and quality assurance documents form part of this.

### 3.3 Delivery report

During the implementation and delivery phases, it has to be established that the protection options actually comply with the required specifications. This is done by testing the active fire protection systems, as well as verifying the certification and the QA documents.

### 3.4 Enforcement

Enforcement starts with the building conditions in the planning permission. Construction that deviates from the planning permission and the conditions attached to it is not allowed. When planning permission is granted and the equivalence has been approved, implementing this solution becomes obligatory for the initiator.

### 3.5 Quality of reports

The party applying for planning permission shall substantiate the FSE solution by submitting technical documents. The applicant can expedite the assessment of the application by ensuring that technical reports are easy to understand. Although complying with this quality requirement does not provide any guarantee of a positive assessment of the protection options chosen, submitting adequate technical reports makes the practical contents of the application easier to assess. Good interaction between the informal discussions and the formal procedures serves to improve quality. Incomplete reports or extracts of reports are often insufficient for the purpose of assessing the solution proposed. Figure 44 shows a summary of areas that require special attention as regards quality requirements set on technical reports. Verification questions were used for this. The summary covers the entire period including the granting of planning permission.

Areas that require special attention	
Parts in technical reports	Verification questions
General details	Are the basic details of the applicant/initiator, the building location, the building plan and the parties involved in the design complete?
Objective	Is the objective of the report clearly described? Is it a quick scan report, a 'scenarios, risks and protection options' report or a final report on equivalent fire safety?
Description of the plan	Is the building clearly described? For example: plot, its location, dimensions, connections to existing buildings, building method, layout, materials used and purpose.  Is the report accompanied by the necessary drawings and illustrations with the right level of detail?
Method	Is the method that has been used easy to follow and described in full?  Is it clear why the method was chosen?  Has the scope of the method been identified explicitly and are any uncertainties mentioned?  If calculation and/or simulation models have been used in the method: <ul style="list-style-type: none"> <li>• Has a description of the validation history been added?</li> <li>• Is the input valid?</li> <li>• Is there consensus as to the input?</li> <li>• Are calculations easy to understand?</li> <li>• Have the relevant details been enclosed correctly, in the form of tables, graphs etc.?</li> </ul>
Assessment and conclusions	Can the conclusions be traced back to the objectives and basic assumptions and are they based explicitly on the details presented?  Are the conclusions explicitly connected to the fire protection measures and facilities proposed?  Are the fire protection measures and facilities that are proposed sufficiently robust and can they be maintained *)? *) certification may be part of this.
Notes: <ul style="list-style-type: none"> <li>• The fire protection options must not contradict other sections of the Dutch Building Decree and other statutory schemes.</li> <li>• The activities of government bodies and their interrelationships must be considered. Examples of this are schemes for environmental care and the preservation of monuments and historic buildings.</li> </ul>	

**Figure 44** Summary of areas that require special attention for quality requirements set on technical reports

### 3.6 Disputes regarding reports

In practice, the initiator and the party deciding on the planning permission may differ as regards the question of whether the solution chosen will lead to the envisaged objective. This may happen during the initial discussions or after the application for planning permission has been filed. Such a stalemate may emerge during the initial discussions by research results being disputed and a second opinion being sought; by the application being continued without the difference of opinion being removed; or by the application being frozen temporarily and resulting in a delay while new research is carried out. After the application has been submitted, a stalemate can emerge if the authority that decides whether or not to grant planning permission asks for additional details and documents; the decision to reject the application due to insufficient details or documents having been submitted; objection or appeal proceedings.

Every form of a stalemate will at least lead to a delay, and will mostly also involve unnecessary extra costs. Applying the process model is recommended in order to avoid stalemates. Furthermore, it is recommended that, if there is a dispute about whether a solution is equivalent, the initiator and the party deciding on the planning permission consider a process arrangement to get out of this stalemate. Options that might be considered here are hiring an independent party, mediation instead of legal proceedings and having the dispute adjudicated by the Dutch national government's Advisory Committee on the application of fire safety rules (*Adviescommissie praktijktoepassing brandveiligheidsvoorschriften*). This committee should support governments, companies and private citizens in situations where there is any ambiguity as to the application of fire safety rules. In addition to the Dutch Building Regulations Helpdesk (*Helpdesk bouwregelgeving*), the Advisory Committee provides advice in situations where the parties cannot come to an arrangement together.

To prevent a stalemate and to improve the quality of fire protection design, the parties can also hire a third party in advance to have them carry out a peer review, provided that the parties trust each other and such trust is maintained during the entire process and they are willing to make the necessary changes as suggested by the third party.

## **Chapter 4**

# **Fire safety measures and facilities**







## Introduction

This chapter uses the model-based approach (conceptual framework) set out in chapter 1 to concretely outline the actual fire protection measures and facilities. This is based on the statutory framework and the basic assumptions and objectives of fire prevention (see chapter 6). In order to be able to determine the measures and facilities, a normative fire development was assumed with a phased subdivision in time matching the basic assumptions in the applicable building regulations. The measures and/or facilities outlined in this chapter are areas that are given special attention in most normal and applicable fire safety options in buildings. They are not statutory requirements and/or regulations. In their interrelationship they indicate an integral approach to fire protection that matches the basic assumptions of the regulations currently in force. The areas that require special attention can also be used as references for a risk-based approach to fire safety (see chapter 3). Some assumptions have to be made both before and while designing fire protection measures and facilities. For example, there is interaction between the fire prevention measures in a building and any repressive intervention by the fire service. These assumptions have been described in this chapter as follows: 'It is/has been assumed that...' or 'Here it is/has been assumed that...'. It goes without saying that, by making these assumptions, we do not intend to interfere with the work or regulations of local authorities. In accordance with their specific remit, local authorities can apply their own policies as regards any intervention by the fire service.

Section 1 addresses the various phases of normative fire development and the associated basic assumptions. Four risk groups can be differentiated for this, depending on certain risk factors. Section 2 describes the system of fire protection measures and facilities as regards environmental characteristics, building characteristics and intervention characteristics. The measures and facilities cannot be viewed separately from human behaviour in the event of a fire. This is particularly important to escape safety. Section 3 focuses on the fire safety balance and pays attention to such matters as implementing protection options in relation to the height of a building and the principle of the interchangeability of protection options. Section 4 discusses the additional risk assessment and evaluation in view of setting up an adequate in-house emergency response organisation. The objective of this is to achieve an optimum match between a building and the intervention by the in-house emergency response organisation and the fire service in the event of a fire.

## 1. Phases of normative fire development, plus basic assumptions

To be able to determine the measures and facilities, a normative fire development with a phased subdivision was assumed. The phases are based on a subdivision into time periods, with basic assumptions connected to them. These basic assumptions closely match the general assumptions of the building regulations (the 2012 Dutch Building Decree - *Bouwbesluit 2012*). The subdivision of the normative fire development into time periods should not be considered as an attempt to set target values. These are only maximum times. It goes without saying that the shorter the time periods are, the better this will be for fire safety. The phases of a normative fire development depend on the decisive risk factors such as whether any people in the building are sleeping and to what extent they are able to leave the building without assistance. The phases are correlated to the risk of a building (see also section 7 of chapter 5). A short extract from this chapter is repeated below for clarity's sake. See figure 45. This deals with the subdivision of buildings into four groups of buildings, based on the most influential risk factors. The division of the normative fire development into phases is also explained in further detail for every individual group of buildings.

Building group	Dominant risk factors	Type of building
1	people who can leave without assistance	office buildings educational buildings public buildings industrial buildings
2	people who can leave without assistance, sleeping	guest accommodation buildings
3	people who cannot leave without assistance, sleeping	healthcare buildings cells and buildings housing cells
4	residents who can leave without assistance, sleeping	residential buildings and homes

Note with the figure:

Only a limited number and range of building types are listed here. A classification of the different types of buildings is provided in Annex A, Building profiles. This includes buildings intended for special accommodation, such as residential care buildings and nurseries. The current practice in the sector covering accommodation buildings where care is provided is to combine residential stay and care. The legal context of building regulations often gives rise to the discussion as to whether a building is a residential building, an intermediate form, or a healthcare building. Such a discussion, that is based on a purely legal perspective makes little sense from the perspective of providing protection against fire, unless the discussion focuses on the people both posing and carrying the risk. If such people are not able to leave without assistance, or if their ability to leave without assistance is limited, the fire protection options must be adjusted accordingly. This also applies to nurseries and homes for the elderly. The healthcare provider has great responsibility in this respect.

**Figure 45** Groups 1 - 4: risk factors related to the types of building

The subdivision makes a distinction between residential and non-residential buildings, as residential buildings involve safety situations in the personal domains of private citizens. This group's risk profile is different from that of non-residential buildings and requires a different approach to fire prevention.

The times of interest for the phases are the discovery and alerting time, the reporting time (to the central control room), the evacuation time, and the fire service's intervention time. This latter time is the aggregate of the response and attack times, the rescuing and fire extinguishing times, the damping down time, and the after-care time. These latter two times are not discussed in this document. When determining the fire development phases, it must be noted that the periods from the moment a fire starts until the evacuation time form a period that is aimed specifically at the user or occupant of a building, since the fire service cannot take action until the report that fire has broken out has been received at the fire service's central control room. The user or occupant also has the possibility of influencing the first periods so that a better fire safety result may be achieved. In those cases where the use of automatic fire detection plays a role, a maximum discovery time expressed in minutes has been assumed. However, it must be noted that, in practice, the discovery time does not depend on the time, but that a smoke detector is triggered by a certain amount of smoke. The risk would still be acceptable if there were a small amount of smoke.

When defining the fire development phases and determining the fire safety measures and facilities, some assumptions have to be made. Here, these assumptions are realistic and of a general nature. An example is the fire service's intervention time. The actual authority for this rests with the local authorities.

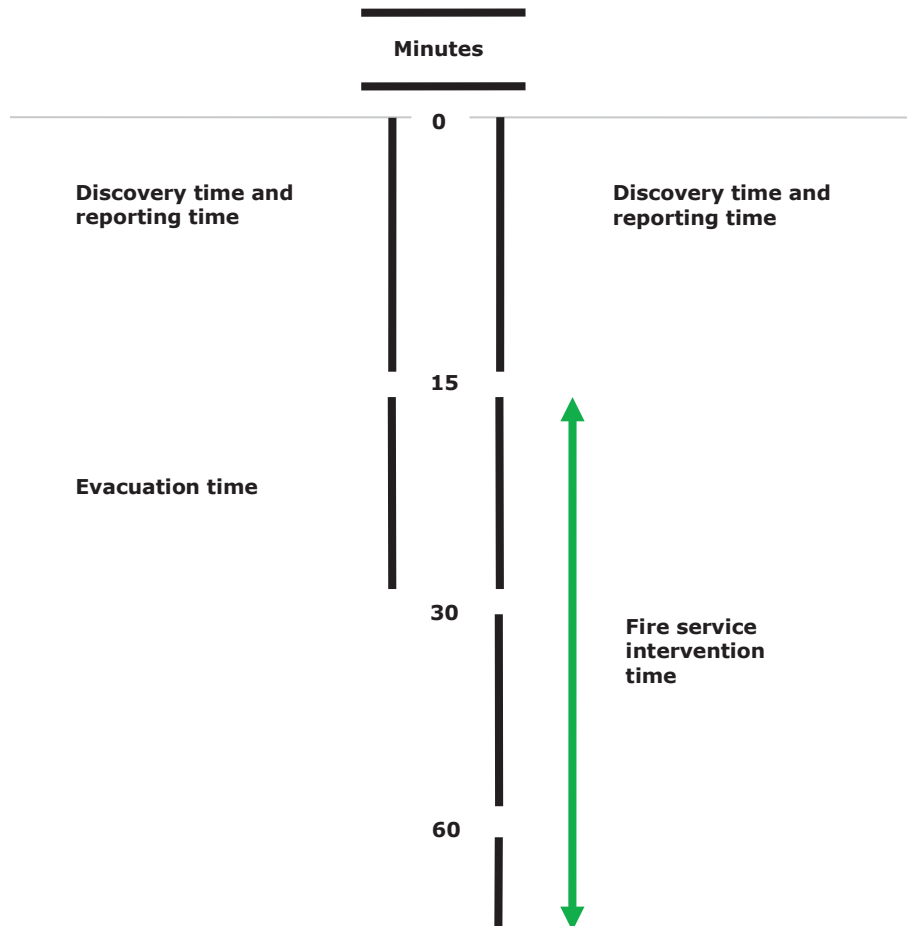
Figures 46 - 49 show the different phases of building groups 1 - 4. The phases that are related to intervention by the in-house emergency responders are shown on the left; the phases related to the intervention by the fire service are on the right.

### **Combined buildings**

Combined buildings are buildings to which the basic assumptions for more than one group apply. An example of this is a hospital where a combination of risk factors is present, i.e. people at risk who cannot leave the building without assistance, or who can only do so to a limited extent, the staff and the visitors. In that event, the basic assumptions for group 1 and group 3 apply. In actual practice, this will not give any problems, since the basic assumptions for group 1 can be integrated in group 3. There are many buildings that harbour such combinations of risk factors.

## 1.1 Group 1 - People who are able to leave without assistance

Examples of buildings from group 1 are office buildings, educational buildings, buildings with a public purpose, and industrial buildings. Since the most influential risk factors are the same, similar phases of normative fire development can be applied to all buildings in this group, but this does not mean that the risk profiles of all buildings in the group are the same. This may vary between different types of buildings and different buildings.



Note:

The times stated are maximum times and should not be considered as target times. The general rule is: the shorter the time, the better this will be for fire safety.

The phases that are related to intervention by the in-house emergency responders are stated on the left. The phases that are related to intervention by the fire service are stated on the right.

**Figure 46** Phases to be differentiated, group 1

When defining the normative fire development phases, it can be assumed for buildings with people who can leave without assistance that:

- the fire will have been discovered, the people endangered by the fire will have been warned and the fire will have been reported to the control room within 15 minutes of the fire starting.

Here it has been assumed that there are no people present in the part of the building concerned and that the fire is discovered by people in other parts of the building, or in the surroundings of the building, at the moment of flashover when the windows break in the room where the fire is located causing a lot of noise, and the flames come out of the building. If there are any people inside the actual part of the building where the fire starts, it may be discovered a lot quicker.

Note:

Although we are aware that the moment of flashover is often sooner nowadays, or does not take place at all in case of a ventilation-controlled fire, we have still assumed a time of 15 minutes.

- the people endangered by the fire will be able to escape to a safe location outside the building, possibly assisted by the in-house emergency responders but without the fire service's assistance, within 15 minutes. In other words: people endangered by fire should have left the building, without the fire service's assistance, within a total of 30 minutes of the fire starting.

It has been assumed in this case that, while fleeing from the building, the doors to stairwells and/or fire compartmentation doors are opened once or several times to let people pass through them. Some smoke will penetrate from the floor/location of the fire into the stairwell or the other fire compartment. For at least 30 minutes after the start of a fire, the stairwell or the other fire compartment will be free from large amounts of smoke.

- the fire service will have arrived and be operational within 15 minutes of the fire being reported to the central control room. In other words: the fire service will be present and operational within 30 minutes of a fire starting.

Here, it has been assumed that the fire service is present in good time. Defining being 'present in good time' is one of the decisions taken by the regional authorities as part of the risk profile that the governing body of a Dutch safety region has adopted, based on the Dutch Safety Regions Act (*Wet veiligheidsregio's*). See chapters 1 and 6 for further information.

- the fire service has the fire under control within 60 minutes of the fire starting. Until that moment, the fire service's efforts are focused on rescuing any people that may still be endangered by the fire. In other words: it is assumed that the fire service focuses its efforts on rescuing people in the endangered area and preventing the fire spreading further within 30 minutes of the fire service becoming operational.

To enable people to be rescued and limit the spread of the fire, the fire must be kept under control and must not be allowed to spread beyond a predefined area. Starting from the normative fire development, this means that, in general, there is a structure between the predefined area and areas located next to, over or under it, preventing a fire that started in such area from spreading to another area for 60 minutes. This time of 60 minutes has been found to be a time that can be achieved quite well in practice. The 60-minute limit also applies to buildings on adjacent plots.



Building group 1: people who are able to leave without assistance / e.g. a school

### *Industrial buildings*

When defining the phases of normative fire development, the fire load (the sum of the permanent and variable fire loads) has been assumed to be lower than 60 kg of pine wood/m<sup>2</sup>. In theory, in relation to the preventative measures and facilities to be implemented, a fire with such a fire load will be under control without any fire extinguishing action being taken within an hour of its starting, since a fire load of 60 kg of pine wood/m<sup>2</sup> will burn for approximately 60 minutes. If the fire load is greater than 60 kg of pine wood/m<sup>2</sup> and the fire service is capable of putting the fire out, the fire is also considered to be 'under control'. The fire development phases are then identical to those of group 1.

However, in a situation where the fire load is greater than 60 kg of pine wood/m<sup>2</sup> and the fire service is not able to extinguish the fire, there is a different fire development, resulting in different fire development phases. Instead of the fire service being in control of the fire within 60 minutes of the fire starting, there will now be an uncontrolled situation of 60 + X minutes. Take, for example, an industrial building where mainly plastics

are stored. If these materials get involved directly in the fire, the fire will develop faster, resulting in a greater heat load on the surroundings, including the building structures. In practice, the '+ X minutes' have to be determined in detail.

An implementation instrument that was developed for the '+ X minutes' is the Dutch Controllability of Fire (*Beheersbaarheid van Brand*) method (2007). This method has replaced the original Controllability of Fire concept and the accompanying Calculation and Decision Model (*Reken- en beslismodel*) from 1995. The experiences gained by using the earlier publications have been incorporated into the updated version, but the basic principles of both versions are similar.

### **The Controllability of Fire method**

The Controllability of Fire method from 2007 is a tool for defining the aspect of 'controlling fire spread' in large fire compartments, i.e. fire compartments that are not covered by the performance requirements defined in the Dutch Building Decree. The method enables choices to be made in order to keep fires controllable. The method can be used in the context of applying equivalent safety measures. It does not set binding regulations. It is quite possible that other methods are applied which serve the same purpose. The Controllability of Fire method does not state any defined fixed size for fire compartments, but makes the size dependent on the location, on facilities to be implemented, and on the amount of combustible material on and in a large fire compartment, i.e. the combustible elements of the structure (permanent fire load) plus the intended maximum amount of combustible materials in the compartment (variable fire load). The calorific value of the materials is important in this respect. The Controllability of Fire method is based on the amount of combustible material. The principle is: the greater the fire load, the smaller the fire compartments and the higher the fire resistance value of structures. On the other hand: the smaller the fire load, the larger the fire compartments and the lower the fire resistance value of structures. The method contains four packages of measures. A package of measures contains indications as to which facilities should be implemented with a view to controlling fire.

#### *Package of measures 1*

In this basic package, the total fire load on and in the fire compartment is limited to the equivalent of 300 tons of pine wood (= 5,700 GJ). The average fire load then indicates how large the fire compartment can be. If the intended use involves a higher fire load, this will require a subdivision into more fire compartments or another package of measures. According to package 1, the requirements on the envelope around fire compartments can depend on the 'normative fire load'. Depending on the above, the size of the fire separations, and of any free space along walls, a safety margin must be included in the resistance to fire penetration and external fire spread of the envelope. The total resistance to fire penetration and external fire spread can vary per side, from 60 to 240 minutes. The number of singly configured connections to adjacent compartments is limited to two. The exact



requirement for outside walls depends on various factors, including where and how they are situated, especially the free space in front of the wall. The method contains a specific calculation of the contribution of distance to the resistance to fire penetration and external fire spread.

#### *Package of measures 2*

Package 2 applies if a number of requirements are fulfilled, including the necessity of an automatic fire alarm system, smoke and heat ventilation to reduce the smoke density, and a limited fire spread speed. The maximum fire load allowed then is the equivalent of 600 tons of pine wood (= 11,400 GJ). With use comparable to that described above, this will lead to a fire compartment that is twice as large. The accompanying requirement as to the resistance to fire penetration and external fire spread of the envelope around the fire compartment depends on the normative fire load as referred to in package 1 and varies between 60 and 240 minutes. However, a safety margin is not required for the resistance to fire penetration and external fire spread, and the number of singly configured connections between fire compartments made in accordance with package 2 is not restricted. The exact requirement for outer walls also depends on the actual distance.

#### *Package of measures 3*

The third package only applies to special cases of bulk storage, with a compact, stacked fire load of the equivalent of at least 300 kg of pine wood per m<sup>2</sup> and a low burn down speed. The fire compartment must have an automatic fire alarm system and the resistance to fire penetration and external fire spread of the envelope must be at least 240 minutes. The maximum storage capacity allowed for one fire compartment is the equivalent of 3,000 tons of pine wood (57,000 GJ). The average fire load indicates how large the fire compartment can be. Singly configured connections to other fire compartments are not allowed. The exact requirement for outer walls also depends on how and where they are situated.

#### *Package of measures 4*

Package 4 assumes the presence of a sprinkler system and comes in three configurations. Depending on the configuration and reliability of the system, the maximum fire load allowed in such a fire compartment is the equivalent of 6,000, 7,500 or 9,900 tons of pine wood (114,000, 142,500 or 188,100 GJ respectively). The maximum size of the fire compartment can be quite considerable and depends on the average fire load. The average fire load of the fire compartment dictates the requirements as to the envelope, with the maximum requirement increasing as the compartment becomes bigger, from 0 (on a company's or institution's own ground's) to a maximum of 240 minutes. The required resistance to fire penetration and external fire spread of the envelope also continues to be restricted to the numeric value of the average fire load. No limits have been set as regards the number of singly configured connections between fire compartments with sprinkler systems. The scope of application of package 4 is the widest scope of the four packages of measures.

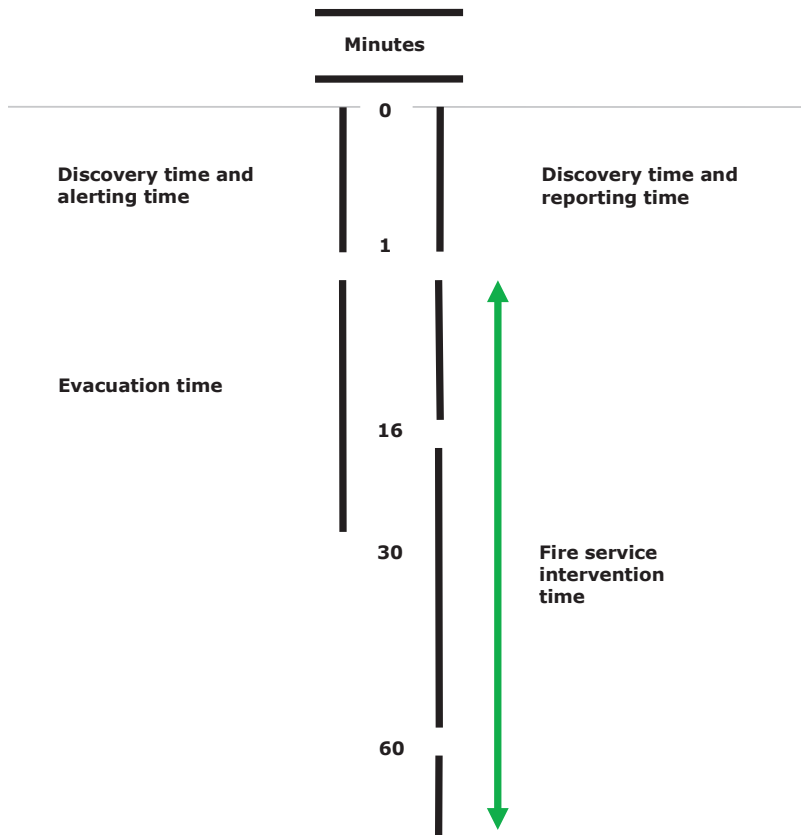
### ***A closer look at the Controllability of Fire method***

The developments in the context of the future view of the Dutch fire service, the *'Brandweer over morgen'* (Fire Service for Tomorrow) require some further comments as to the current version of the Controllability of Fire method. For reasons of risk containment, a repressive attack by the fire service is used in some parts of the method. This specifically applies to those cases where it is assumed that the fire service will fight the fire inside the building. This is the case, for example, with package of measures 2 (automatic fire alarm system and smoke and heat ventilation) and in situations where it is assumed that the fire service will make connections between fire compartments safe by a repressive attack in a building. However, assuming an attack creates incorrect expectations as to the possibilities of deploying the fire service.

This form of attack is going through substantial changes, partly as a result of developments in the context of the future vision of the fire service. If repressive attack opportunities are not as wide ranging as those that the Controllability of Fire method takes into account, safety cannot be determined with any certainty. In line with developments in the context of the future vision of the fire service, the Controllability of Fire method will have to be adjusted accordingly.

## 1.2 Group 2 - People who can leave without assistance, sleeping

An example of a building in group 2 is a guest accommodation building.



Note:

The times stated are maximum times and should not be considered as target times. The general rule is: the shorter the time, the better this will be for fire safety.

The phases that are related to intervention by the in-house emergency responders are stated on the left. The phases that are related to intervention by the fire service are stated on the right.

**Figure 47** Phases to be differentiated, group 2

When defining the normative fire development phases for buildings where people sleep and who can leave without assistance, it can be assumed that:

- the fire will have been discovered, the people endangered by the fire will have been warned and the fire will have been reported to the control room within one minute of the fire starting.

This assumes that the building has a fire alarm system with full monitoring and direct reporting to a control room.

- the people endangered by the fire will be able to escape to a safe location outside the building, possibly assisted by the in-house emergency responders but without the fire service's assistance, within 29 minutes. In other words: people endangered by fire must have left the building, without the fire service's assistance, within 30 minutes of the fire starting.

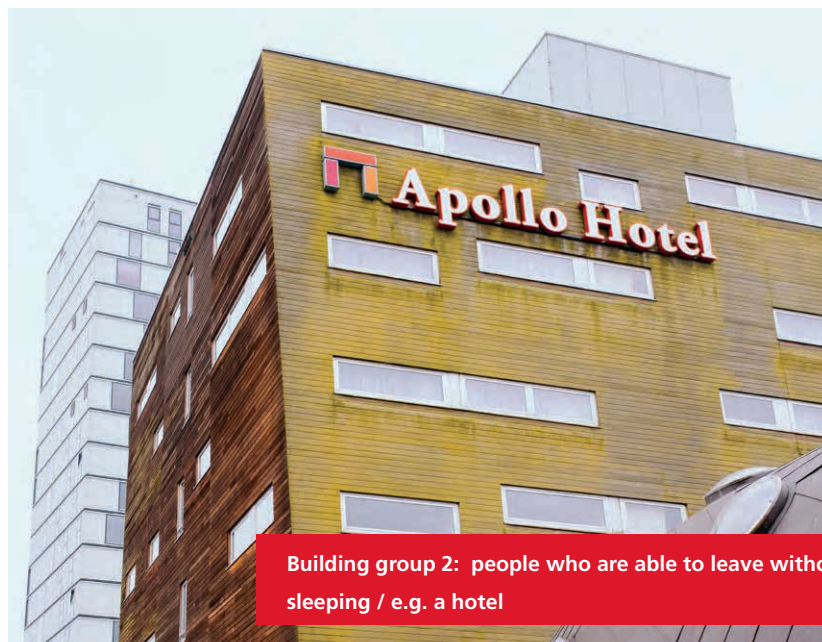
It has been assumed in this case that, while fleeing from the building, the doors to stairwells and/or fire compartmentation doors are opened once or several times to let people pass through them. Some smoke will penetrate from the floor/location of the fire into the stairwell or the other fire compartment. For at least 30 minutes after the start of a fire, the stairwell or the other fire compartment will be free from large amounts of smoke.

- the fire service will have arrived and be operational within 15 minutes of the fire being reported to the central control room. In other words: the fire service will be present and operational within 16 minutes of a fire starting.

Here, it has been assumed that the fire service is present in good time. Defining being 'present in good time' is one of the decisions taken by the regional authorities as part of the risk profile that the governing body of a Dutch safety region has adopted, based on the Dutch Safety Regions Act. See chapters 1 and 6 for further information.

- the fire service has the fire under control within 60 minutes of the fire starting. Until that moment, the fire service's efforts are focused on rescuing any people that may still be endangered by the fire. In other words: it is assumed that the fire service focuses its efforts on rescuing people in the endangered area and preventing the fire spreading further within 30 minutes of the fire service becoming operational.

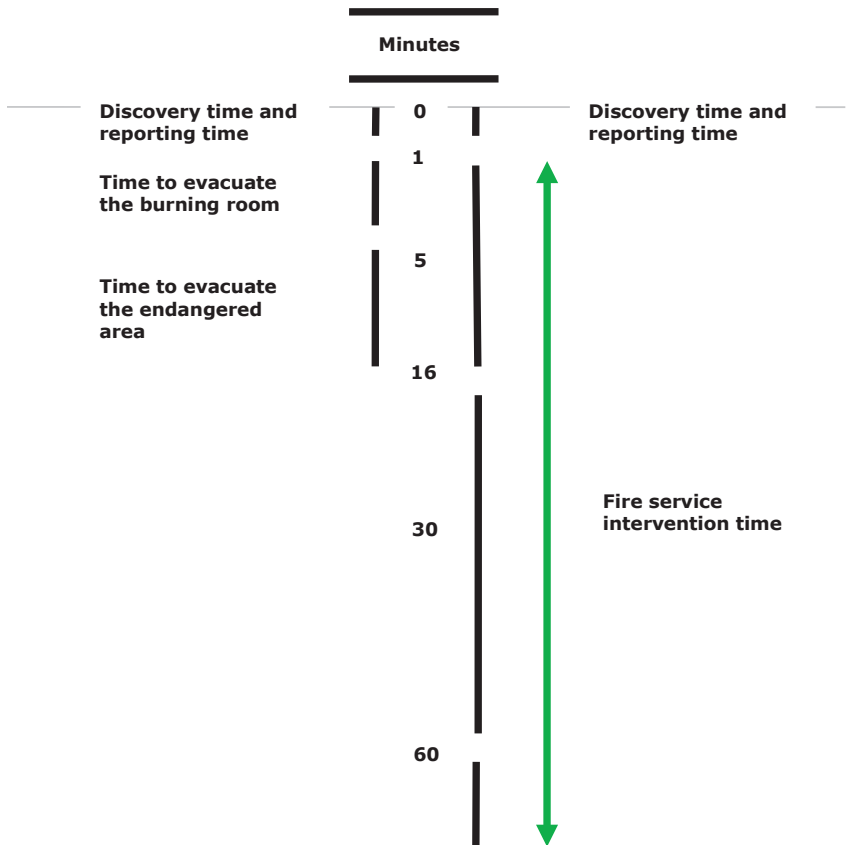
To enable people to be rescued and limit the spread of the fire, the fire must be kept under control and must not be allowed to spread beyond a predefined area. Starting from the normative fire development, this means that, in general, there is a structure between the predefined area and areas located next to, over or under it, preventing a fire that started in such area from spreading to another area for 60 minutes. This time of 60 minutes has been found to be a time that can be achieved quite well in practice. The 60-minute limit also applies to buildings on adjacent plots.



Building group 2: people who are able to leave without assistance, sleeping / e.g. a hotel

### 1.3 Group 3 - People who are not able to leave without assistance, sleeping

Examples of buildings in group 3 are healthcare buildings, such as hospitals, and buildings that house cells.



Note:

The times stated are maximum times and should not be considered as target times. The general rule is: the shorter the time, the better this will be for fire safety.

The phases that are related to intervention by the in-house emergency responders are stated on the left. The phases that are related to intervention by the fire service are stated on the right.

**Figure 48** Phases to be differentiated, group 3

When defining the normative fire development phases for buildings where people sleep who are not able to leave without assistance it can be assumed that:

- the fire will have been discovered, the staff and the in-house emergency responders will have been warned, and the fire will have been reported to the control room within 1 minute of the fire starting.

Here it has been assumed that the building has a fire alarm system with full monitoring (coverage) and direct reporting to the control room, and that the staff and the in-house emergency responders will be alerted automatically, without any third parties intervening.

- the people endangered by the fire must have been brought from the

room affected by the fire to a safe location within 4 minutes of the in-house emergency responders having been alerted.

Here it has been assumed that at least two in-house emergency responders have arrived at the room with the fire within 2 minutes and that the people have been brought to safety from the room with the fire \*) within 2 minutes. The door to the room in which there is a fire must then be shut. Since more staff are available in the daytime than at night, the evacuation can be started almost immediately in the daytime.  
\*) a patient room in a healthcare building, a cell in a building that houses cells.

- the people endangered by the fire must have been removed from the endangered area of the building within 15 minutes of the in-house emergency responders having been alerted, after which these people are brought to a safe location.

Only for buildings that house cells: it has been assumed that the fire service will not take action until the lines of attack are free from inmates. The fire service will only take action in emergency situations, depending on the conditions and findings. This note does not apply to healthcare buildings with psychiatric patients.

- the fire service will have arrived and be operational within 15 minutes of the fire being reported to the central control room. In other words: the fire service will be present and operational within 16 minutes of a fire starting.

Here, it has been assumed that the fire service is present in good time. Defining being 'present in good time' is one of the decisions taken by the regional authorities as part of the risk profile that the governing body of a Dutch safety region has adopted, based on the Dutch Safety Regions Act. See chapters 1 and 6 for further information.

- the fire service has the fire under control within 60 minutes of the fire starting. All people that might still be endangered by the fire must have been rescued by then. In other words: it is assumed that the fire service will have rescued any people that might still be in the endangered area and has, in principle, prevented the fire from spreading further within 44 minutes of the fire service becoming operational.

To enable people to be rescued and limit the spread of the fire, the fire must be kept under control and must not be allowed to spread beyond a predefined area. Starting from the normative fire development, this means that, in general, there is a structure between the predefined area and areas located next to, over or under it, preventing a fire that started in such area from spreading to another area for 60 minutes. This time of 60 minutes has been found to be a feasible time. The 60-minute limit also applies to buildings on adjacent plots.

Note:

The basic assumptions include:

- that for healthcare buildings, there are no more than four people in one room (who are not able to leave without assistance) and who can be relocated using wheeled beds.
- that cells and buildings that house cells have a maximum of two people to one cell (who are prevented from being able to leave without assistance/escaping).



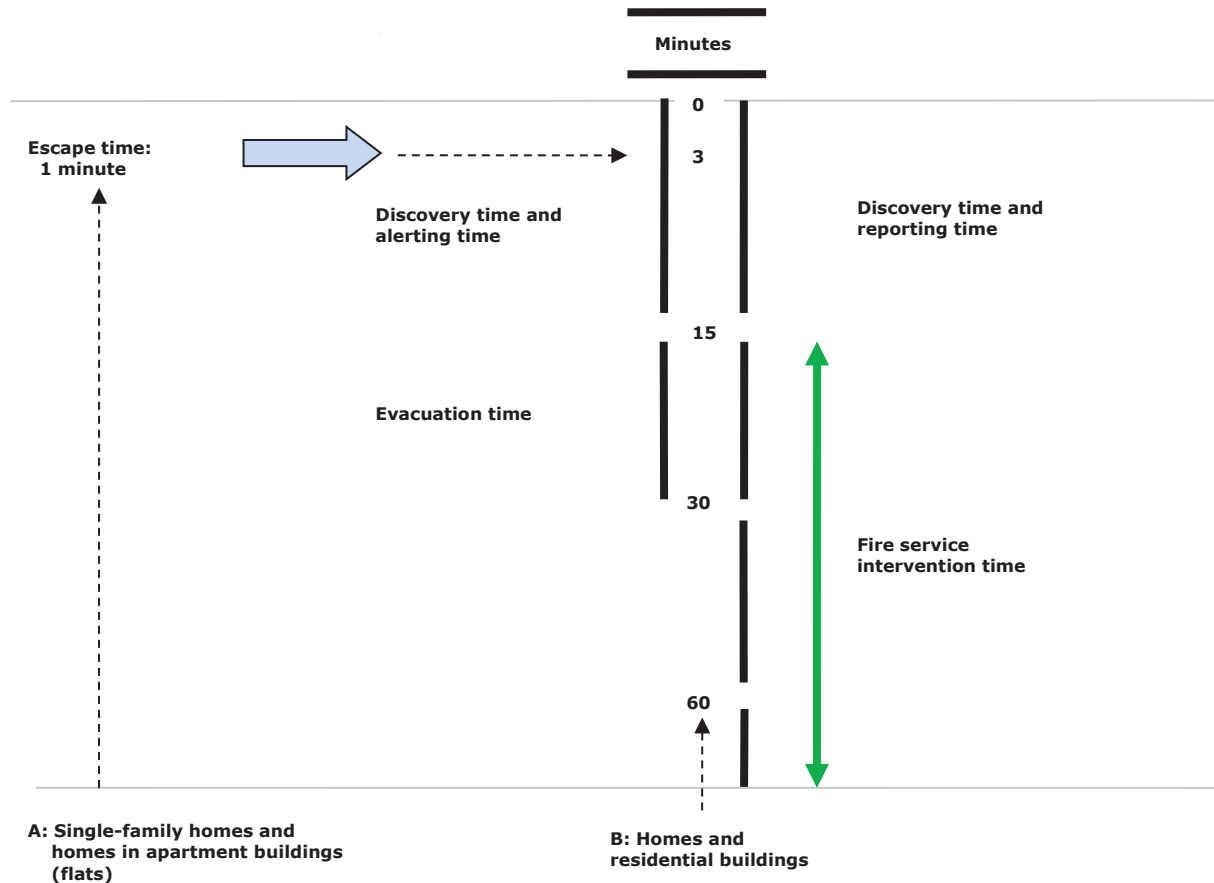


Building group 3: people who are not able to leave without assistance, sleeping / e.g. a hospital



## 1.4 Group 4 - People who can leave without assistance, sleeping - homes and residential buildings

Group 4 is different, since it partly involves safety situations in individual citizens' private domains. Fire safety in this group requires a different approach than would be the case for non-residential buildings.



Note:

The times stated are maximum times and should not be considered as target times. The general rule is: the shorter the time, the better this will be for fire safety.

The phase relating to intervention by the fire service is shown on the right-hand side.

**Figure 49** Phases to be differentiated, group 4

The basic assumptions distinguish between:

- Fire protection in an individual home, such as a single-family home on its own plot, and in a flat in a block of flats.
- Fire protection of the building as such, including people's homes and residential buildings.

For the distinction between A and B, a single-family home on its own plot also qualifies as a residential building.

### **Basic assumption A**

As regards fire protection inside people's private homes (people who can leave without assistance) it has been assumed that:

- the fire has been discovered, the residents (if present) have been warned, and the residents have fled from their home within three minutes of a fire in the home having started.

It has been assumed here that the home has one or more smoke detectors - with inbuilt acoustic signal generators - in the escape route and that, in the event of a fire in the home, the residents have three minutes to reach safety. An evacuation time of one minute has been assumed.

### **Basic assumptions B**

As regards fire protection for people's private homes and residential buildings (people who can leave without assistance) it has been assumed that:

- the fire will have been discovered, the residents endangered by the fire will have been warned and the fire will have been reported to the control room within 15 minutes of the fire starting.

Here it has been assumed that there are no residents present in the home where there is a fire and that the fire is discovered by people in other parts of the building, or in the surroundings of the building, at the moment of flashover when the windows break in the room where the fire is located, causing a lot of noise, and the flames come out of the building. If there are any people inside the actual building where there is a fire, the fire may be discovered a lot quicker.

**Note:**

Although we are aware that the moment of flashover is often sooner nowadays, or does not take place at all in case of a ventilation-controlled fire, we have still assumed a time of 15 minutes.

- the residents endangered by the fire will be able to escape to a safe location outside the building without the fire service's assistance, within 15 minutes. In other words: residents endangered by fire should have left the building, without the fire service's assistance, within 30 minutes of the fire starting.

Here it has been assumed that, while fleeing from a burning home, doors may be left open, which might cause smoke to spread in corridors in the building. Here it has been assumed that, as the residents flee the building, the doors to the stairwell will be opened once or several times to enable residents to pass or flee through them.

Some smoke will penetrate into the stairwell. For at least 30 minutes after the start of a fire, the stairwell will be free from large amounts of smoke.

An opened door in the event of a fire in a porch or doorway will cause smoke to spread in the porch or doorway.

- the fire service will have arrived and be operational within 15 minutes of the fire being reported to the central control room. In other words: the fire service will be present and operational within 30 minutes of a fire starting.

Here, it has been assumed that the fire service is present in good time. Defining being 'present in good time' is one of the decisions taken by the regional authorities as part of the risk profile that the governing body of a Dutch safety region has adopted, based on the Dutch Safety Regions Act. See chapters 1 and 6 for further information.

- the fire service has the fire under control within 60 minutes of the fire starting. Until that moment, the fire service's efforts are focused on rescuing any people that may still be endangered by the fire. In other words: it is assumed that the fire service focuses its efforts on rescuing people and preventing the fire spreading further within 30 minutes of the fire service becoming operational.

To enable people to be rescued and limit the spread of the fire, the fire must be kept under control and must not be allowed to spread beyond a predefined area. Starting from the normative fire development, this means that, in general, there is a structure between a home and homes located next to, over or under it, preventing a fire that started in such home from spreading to another home for 60 minutes. This time of 60 minutes has been found to be a feasible time. The 60-minute limit also applies to buildings on adjacent plots.



Building group 4: people who can leave without assistance (residents), sleeping / e.g. someone's home

## 2. Fire protection measures and facilities

Fire protection measures and facilities aimed at ensuring people's safety are classified as 'safety' measures and facilities and have to be able to function effectively for a relatively long period of time. Fire prevention systems must be sufficiently reliable and robust. 'Reliable' means that a fire protection system functions effectively to protect what it is intended to protect. A robust fire protection system is, as the very least, suitable for the specific conditions in which the system must be able to function. The temperature range is an important factor for technical fire protection systems. The robustness of systems can be improved by providing protection against moisture, dust, explosions, electromagnetic fields and vibrations.

The protection objectives of chapter 1 are the central starting points for concretely outlining the actual fire protection measures and facilities. The measures and/or facilities are areas that require special attention as regards accepted, suitable fire safety options in buildings. They are not statutory requirements and/or regulations. Taken together, the measures and facilities enable an integral approach to fire protection that matches the basic assumptions of the prevailing legislation and regulations, especially those concerning building regulations, leading to an integral framework based on regulations.

The fire protection measures and facilities have been divided into the following focus areas:

- Environmental characteristics
- Building characteristics that are further divided into:
  - architectural measures and facilities
  - technical systems
  - fixtures and fittings
  - occupancy
- Intervention characteristics that are further divided into:
  - the in-house emergency responders
  - the fire service

The aspect of human behaviour is insufficiently considered in the prevailing regulations. Although there are no rules on human behaviour, this does not mean that human behaviour should not be taken into account. It is a crucial aspect from the perspective of people's ability to leave without assistance. This specifically applies to complicated and/or high-risk buildings (see chapter 3).

When opting for a risk-based approach to fire protection, the areas that require special attention serve as a frame of reference since the rules are related to the fire safety level that is required by law. Actually, this statutory level is the minimum requirement.

### **Classification of fire protection measures and facilities by focus areas**

Environmental characteristics are taken to include the situation and the shape of the building in its surroundings, the location of the building relative to the fire station, how easily the building can be reached by the fire service, and the presence of a water facility for fighting fires near the building.

*Architectural* measures and facilities mainly concern the stability of the building or of parts of it during a fire situation, the choice of materials for the different parts of the construction, the safe evacuation of people, and the controllability of a fire.

*Technical systems* are those that serve the building's fire protection, such as fire alarm systems and automatic fire suppression systems. Besides these fire protection systems, buildings also house other types of systems, such as air conditioning systems, lift and elevator systems, and security systems, including automatic access control systems and door locking systems. As these systems may negatively affect fire safety, each of these systems will have to be examined to find out to what extent they negatively affect fire safety, and, if appropriate, effective solutions will have to be found. In specific buildings, such as buildings that house cells, the penitentiary security facilities also require that attention is paid to fire safety. Safety and security are closely linked to one another and must be considered from the perspective of timely and safe evacuation, as well as from the point of view of safely deploying fire service personnel in association with the safety aspects that play a role in the context of the institution's management organisation and its personnel. In other buildings, the overlap between safety and security also calls for attention, for example closed wards in healthcare buildings and door locking systems in office buildings, bank buildings and hotels.

The measures and facilities for the *fixtures and fittings* concern the interior decoration elements and fixtures and fittings, such as furniture, soft fixtures and fittings, appliances and devices, mattresses, bed linen, decorations, etc. The configuration of vehicles such as buses, train carriages and underground trains is important for station buildings. The decoration and set-up of stands, booths, stages, decoration materials, etc. play an important role for some buildings with a public purpose.

*Occupancy* concerns the fire-safe occupancy, also referred to as 'use', of the building, for example keeping escape routes clear, being able to apply an evacuation plan, and providing information about 'what to do in case of a fire'. Occupancy is also taken to mean maintenance carried out to keep measures and facilities in a good state of repair and the activities performed

to inform occupants, for example patients in a healthcare building and the inmates of a building that houses cells.

The *in-house emergency responders* provide first line emergency assistance in the event of a fire: extinguishing an incipient fire and evacuating the building. In a situation with people who cannot leave without assistance, the in-house emergency response organisation should compensate for the inability of people to leave without assistance.

Intervention by the *fire service* concerns the repressive action of the fire service.

The areas that require special attention as regards the fire protection measures and facilities are addressed in sections 2.1 - 2.12. Where special attention is relevant, this is indicated by coloured blocks; if it is not relevant, there will be no block.

## 2.1 Preventing fire

Group 1: can leave without assistance; non-residential buildings	■
Group 2: can leave without assistance, sleeping; non-residential buildings	■
Group 3: cannot leave without assistance, sleeping; non-residential buildings	■
Group 4: can leave without assistance, sleeping; residential buildings and homes	■

Detailed classification of the safety objective:  
Preventing fire is about reducing the risk of fire (risk reduction).

### Surroundings

A building should be situated and shaped such that optimum social control is possible in order to prevent arson.



The distances between buildings should be such that a fire in one building will not cause a fire in another building.



### Architectural measures and facilities

The degree of combustibility of the construction elements and parts used must be limited such that the risk of fire propagation, given the intended use of the room where such construction elements and parts are applied, is sufficiently slight.



Materials used in, on or near a smoke duct must be such that no fire can occur as a result of the temperature of such materials rising due to the appliance connected to the duct.



Materials applied in, on or near a combustion appliance must be such that no fire can occur as a result of the temperature of such materials rising due to the appliance.



A roof must not be such that exposure to fire spread by wind can easily cause a fire.



The building should have effective anti-intruder facilities to reduce the risk of arson.



### Additional information for industrial buildings

Materials used in, on or near process equipment or a machine must be such that no fire can occur as a result of the temperature of such materials rising due to the equipment or the machine.



### Additional information for industrial buildings

Materials used in rooms where substances that have an oxidising action are stored must be such that any leaks of such substances do not easily lead to a fire.



### Additional information for industrial buildings

There must be sufficient ventilation in a room where an ignitable atmosphere may occur.



*Note:*

*The occurrence of explosive vapours may be prevented by applying natural ventilation. If this is found to be insufficient, a solution in the form of a technical system will have to be found.*

### Technical systems

There must be an effective lighting system around a building.



Note:

*This is an aspect of social safety that here serves to help prevent arson.*

Power supplies (gas, electricity) must not easily cause fire.



Only approved technical systems must be used.



The services of accredited installers must be enlisted for installing electrical, gas and similar systems.



A building which - due to its location in a remote area or in a high position compared to its surroundings - is susceptible to being hit by lightning must be protected by means of an effective lightning conductor system.



### Additional information for educational buildings

A building should have an effective intruder detection system to reduce the risk of arson.



### Additional information for industrial buildings

It should not be possible for machines, systems, and production equipment, etc., to cause a fire.



### Additional information for industrial buildings

Rooms in which an ignitable atmosphere may occur must be fitted with devices to prevent such atmosphere from occurring or to shield sources of ignition, for example in order to prevent a dust explosion.



### Fixtures and fittings

The fixtures and fittings used must be as fire safe as possible. This applies to items such as:



- furniture, soft fixtures and fittings, decorations and equipment for all buildings
- mattresses and bed linen for buildings where people sleep
- stands, stages, decorations and merchandise for buildings with a public purpose.

Only self-extinguishing waste bins must be installed.



Only approved equipment (e.g. the Dutch KEMA approval, etc.) must be used.



Only a limited number of items of furnishing and clothing should be allowed in accommodation rooms, such as client/patient rooms in healthcare buildings, and in cells in buildings that house cells.



If there is a risk of improper or other than intended use of cooking or heating equipment which might lead to a fire, adequate measures have to be taken to prevent this.



Note:

*For example microwave ovens in prison cells and electrical ranges in homes for the elderly or in nursing homes must have an adequate thermal cut-out switch and/or a timer switch.*

The use of fire safe products in homes and residential buildings should be promoted. Examples of such products are:



- fixtures and fittings, such as furniture, mattresses, soft fixtures and fittings and decorations
- approved equipment, such as electrical appliances and devices
- dustbins and waste paper baskets that automatically extinguish any burning waste

### Additional information for industrial buildings


Process and general equipment, machines, etc. must be approved where possible (e.g. the Dutch KEMA approval).







Group 1: can leave without assistance; non-residential buildings	
Group 2: can leave without assistance, sleeping; non-residential buildings	
Group 3: cannot leave without assistance, sleeping; non-residential buildings	
Group 4: can leave without assistance, sleeping; residential buildings and homes	

**Additional information for industrial buildings**


Where possible, fire safe materials should be opted for when deciding on the machines, tools, process and other equipment, and the materials and consumables to be used. 

**Occupancy**

In places with an increased fire risk, e.g. if hazardous materials are present, a smoking ban must be imposed and the use of open flames must be prohibited. 


It must be ensured that people who can be expected to want to start a fire, such as the inmates in a building that houses cells and patients/clients in a healthcare building, do not have, nor can get, any sources of ignition (lighters, matches) in their possession. 

**Additional information for cells/buildings that house cells and mental healthcare institutions**


It is up to the institution to decide whether smoking is allowed in cells/buildings that house cells and mental healthcare institutions. 


Note:


*This does not imply that cells in buildings that house cells and accommodation rooms in mental healthcare institutions are not locations with an increased fire risk. They may actually have an increased fire risk since they house people who will not be able to leave them without assistance if a fire breaks out. The correlation with the amount of combustible materials in a room in combination with the presence of possible sources of ignition plays a role in this regard.*

Periodic checks must be carried out in order to prevent fire hazards. Pay attention to issues such as: 

- the distance of spot light fixtures from curtains and decorations
  - audiovisual equipment, computers etc. being left on stand-by permanently
  - self-extinguishing ashtrays and similar devices being emptied in good time
  - keeping the building neat and tidy
  - maintaining the number of fixtures and fittings allowed
  - preventing combustible goods from being stored against outer walls.
- \*) for residential buildings

Instructions for safely carrying out work that poses a fire hazard must be present and must be complied with. Examples of such work are welding, flame-cutting, roofing etc. This also applies to hobby activities and to educational activities, e.g. physics and chemistry tests in school science labs.    
\*) for residential buildings

Instructions for occupants should be drawn up and should include such requirements as:    
• only hiring the services of accredited installers  
• carrying out periodic maintenance on technical systems and equipment  
• avoiding combustible outdoor storage and open waste skips  
• minimising the storage of gas cylinders and other pressurised containers.  
\*) for residential buildings

Periodic checks aimed at prevention and/or timely identification of breaking and entering, vandalism, etc. must be carried out.    
\*) for residential buildings

Staff must be instructed and trained such that their behaviour is structurally focussed on preventing fire. This must be repeated at regular intervals.

Note:

*Certain buildings require instruction and training to also be provided to specific target groups, such as the inmates of a building that houses cells and the patients/clients of a healthcare building. This instruction and training must be repeated at regular intervals.*

Instruction is an important means of preventing fire in the 'residential' sector. The following subjects may be addressed:

A: the safe use of products and technical systems

B: maintenance

C: dangerous behaviour and risk factors.

A. The safe use of products and technical systems

Examples of this category are:

- cooking appliances, especially if oil or fat is used
- heating devices, including electric blankets, and various burners, including burners to remove paint
- naphtha, Coleman fuel, lighters, matches, etc.
- emptying ash trays and emptying ash drawers of stoves
- minimum use of loose electric cords that are permanently live
- preventing sharp and locally high pressure on cords
- monitoring the fire safety around open fire and heat sources, such as the surroundings of cooking appliances, stoves, central heating units, water heaters, lamps and candles. Ensure that clothing and items of furnishing do not get too near to open flames and sources of heat.

B. Maintenance

Examples of this category are:

- periodic maintenance and cleaning chimneys
- periodic maintenance and replacing lights and other equipment, gas connections and electric leads in good time.

C. Dangerous behaviour and risk factors

Examples of this category are:

- cooking, boiling, baking, roasting, frying combined with the consumption of alcohol, etc. This combination should be discouraged, especially late at night.
- smoking in places and at times when people easily fall asleep: in bed, on a sofa or in an easy chair
- psychological problems, stress, an argument or a fight
- low ability to leave without assistance
- unsupervised children
- a cluttered home.

A special form of risky behaviour or risky occupancy is excessive faith in safety and comfort functions or facilities that are integrated in equipment, such as:

- leaving coffee machines or irons on and relying on their integrated thermal safety facility
- leaving audiovisual equipment, computers and similar equipment on stand-by all the time
- leaving electric blankets switched on all the time, even while airing beds.

**Additional information for industrial buildings**

Periodic checks must be carried out in order to prevent fire hazards. These checks should concern such aspects as:

- the proper functioning of machines, tools and process and other equipment
- checking the condition of the substances and materials stored as regards ageing, undesired reactions, leaks, etc.

- Group 1: can leave without assistance; non-residential buildings
- Group 2: can leave without assistance, sleeping; non-residential buildings
- Group 3: cannot leave without assistance, sleeping; non-residential buildings
- Group 4: can leave without assistance, sleeping; residential buildings and homes

#### Additional information for industrial buildings

When storing, processing or handling raw materials, their specific fire hazard properties must be taken into account. Some substances create reactions that pose a fire hazard when they come into contact with each other, whereas other substances react to weather influences, such as heat or rain, with a similar effect. These substances must be stored separately from each other.

#### Additional information for industrial buildings

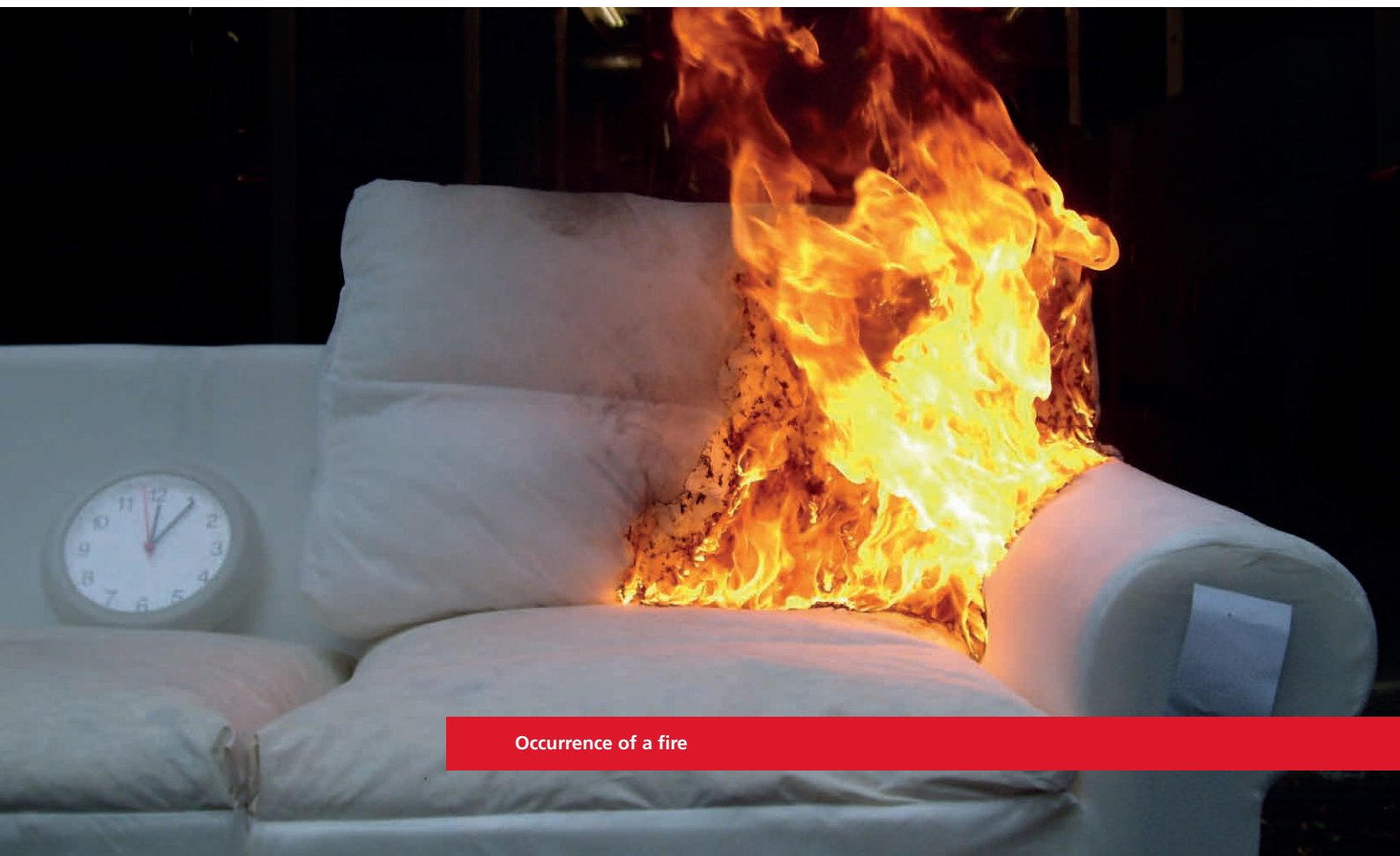
If any substances or processes that may pose a fire hazard are present, the availability of sufficient specialist knowledge must have been arranged. Only properly trained staff should be allowed to handle high fire risk hazardous materials and operate high fire risk hazardous processes.

#### In-house emergency response organisation

Not applicable

#### Fire service

Not applicable



Occurrence of a fire

## 2.2 Early discovery of a fire

Group 1: can leave without assistance; non-residential buildings

Group 2: can leave without assistance, sleeping; non-residential buildings

Group 3: cannot leave without assistance, sleeping; non-residential buildings

Group 4: can leave without assistance, sleeping; residential buildings and homes

Detailed classification of the safety objective:

Discovering a fire as soon as possible is necessary in order to enable safe and timely evacuation. Early discovery is especially important in situations where people are sleeping in a building and/or are not able to leave the building without assistance.

Explanation:

Early discovery of fire may prevent people from dying from suffocation or burning to death. Some examples:

- guests in a hotel room
- patients/clients who are not able to leave without assistance, in a room in a healthcare or residential care building
- inmates locked in a cell in a building that houses cells
- children at a nursery.

An automatic fire alarm system may ensure that fire symptoms, usually smoke, are discovered as soon as possible.

### Surroundings

Not applicable

### Architectural measures and facilities

Not applicable

### Technical systems

The building must have an effective automatic fire alarm system with automatic fire detectors. The degree of protection is full monitoring. The objective is activating the alarm organisation. See 2.7 as to reporting to a control room.

Note:

*If a fire is reported, this must be done unambiguously so as to be able to establish the source of the report as quickly as possible, for example by using a synoptic panel.*

*\*) based on a normal residential building with people who can leave without assistance*

An automatic fire alarm system may be necessary in buildings with such characteristics as high-risk, complex, high, below-ground and/or of a large surface. Quick discovery is necessary in order to activate the alarm organisation. The fire alarm system may also automatically trigger/control an evacuation alarm system, ensuring that any people present are warned and can leave the building.

One or more smoke detectors should be installed in a home, preferably along the escape route.

### Fixtures and fittings

Not applicable

### Occupancy

Staff must be instructed and trained so that their behaviour is structurally in compliance with the rapid discovery and reporting of fire. This must be repeated at regular intervals.

Note:

*Staff should be familiar with how the fire alarm system works and how they should report to the central control room.*

- Group 1: can leave without assistance; non-residential buildings ■
- Group 2: can leave without assistance, sleeping; non-residential buildings ■
- Group 3: cannot leave without assistance, sleeping; non-residential buildings ■
- Group 4: can leave without assistance, sleeping; residential buildings and homes ■

People who are not able to leave without assistance must be instructed and trained so that their behaviour is structurally in compliance with the rapid discovery and reporting of fire. This must be repeated at regular intervals.

*Note:*

*Examples of this are patient/cclients in a healthcare or residential care building, or inmates in a building that houses cells.*

When work that poses a fire hazard, such as welding, flame cutting and roofing, is carried out, a qualified expert must supervise such work at all times.

**Additional information for industrial buildings**

Processes that pose a fire hazard must be under the constant supervision of an expert professional.

**In-house emergency response organisation**

Not applicable

**Fire service**

Not applicable



Discovery of a fire

## 2.3 Raising the fire alarm as quickly as possible

Group 1: can leave without assistance; non-residential buildings	■
Group 2: can leave without assistance, sleeping; non-residential buildings	■
Group 3: cannot leave without assistance, sleeping; non-residential buildings	■
Group 4: can leave without assistance, sleeping; residential buildings and homes	■

Detailed classification of the safety objective:  
Informing in-house emergency responders and other people as soon as possible in order to achieve safe and timely evacuation.

Explanation:

The moment when the alarm is raised and people are warned depends on the time when the fire is discovered. The fastest method is when the alarm/warning is coupled directly to the reporting of the fire and is controlled automatically, becoming active at that moment. Here, it has been assumed that there is very little time between the fire being reported and the alarm being raised.

The alarm may be raised/people may be warned:

- a. without technical aids, for example by calling out to people
- b. using technical aids by:
  - manually operating means of communication
  - automatically activating means of communication
- c. a combination of possibilities a and b.

Technical aids can either be silent or loud alarm systems. Silent alarm systems are mostly used in situations where a selected group of people, i.e. the in-house emergency responders, are alerted, as is the case in healthcare buildings and in buildings that house cells. One of the tasks of the in-house emergency responders is to compensate for people's inability to leave without assistance. Loud alarm systems mainly occur in situations where there are people who can leave without assistance. Examples are specific signal generation (slow whoop) and/or a spoken message. If raising the alarm is not controlled automatically, other kinds of solutions may be provided, e.g. organisational measures. In that event, a maximum alarm generation time/warning time of two minutes is realistic. Raising the alarm to warn people of a fire is directly related to a fire being reported to the fire service (see section 2.7).

### Surroundings

Not applicable

### Architectural measures and facilities

Not applicable

### Technical systems

The necessity of technical aids for alarm purposes depends on the size of the building (surface and/or number of storeys) and the building's floor plan. The criterion for necessity is no longer being able to rely only on the actions of human beings.

*\*) based on a residential building with people who can leave without assistance*

The building should house a communication system such that activation of the alarm system will automatically warn the in-house emergency responders and, if necessary, other staff, without third parties intervening.

In-house emergency responders in the building should immediately receive adequate information about where the fire is, e.g. using a people locator system, when the fire alarm system has been triggered.

Residents in a single-family home or a flat who are endangered by fire and/or smoke must be warned in good time by means of smoke detectors.



- Group 1: can leave without assistance; non-residential buildings ■
- Group 2: can leave without assistance, sleeping; non-residential buildings ■
- Group 3: cannot leave without assistance, sleeping; non-residential buildings ■
- Group 4: can leave without assistance, sleeping; residential buildings and homes ■

**Fixtures and fittings**

Not applicable

**Occupancy**

Not applicable

**In-house emergency response organisation**

Staff must be instructed and trained so that their behaviour is structurally in compliance with rapidly raising the alarm if a fire is discovered. This must be repeated at regular intervals. ■ ■ ■

*Note:*

*Elements to be dealt with in this context is familiarity with how the communication system works in the context of the alarm procedure.*

**Fire service**

Not applicable



## 2.4 Timely evacuation/fleeing in case of a fire

Group 1: can leave without assistance; non-residential buildings

Group 2: can leave without assistance, sleeping; non-residential buildings

Group 3: cannot leave without assistance, sleeping; non-residential buildings

Group 4: can leave without assistance, sleeping; residential buildings and homes

Detailed classification of the safety objective:

The objective of timely evacuation and/or people fleeing is to reach a safe location in the event of a fire. Support by in-house emergency responders may be necessary. Besides fire, there are other situations where the timely evacuation of a building is required, e.g. in the event of a bomb alert or if there is external danger due to risks originating from the surroundings, such as the storage and/or transport of hazardous materials.

Explanations:

- *Human behaviour.* Although the current rule-based approach does not consider human behaviour from the point of view of people being able to leave without assistance, this should definitely be taken into account. This specifically applies to complicated and/or high-risk buildings (see section 2.4.4.2 of chapter 3).
- *15-minute building evacuation time.* The escape routes must be guaranteed to be available from the moment when a fire starts until the end of the evacuation time. The available evacuation time for buildings is assumed to be 15 minutes. In practice, special stairwells, protected by fire and smoke resistant partitioning constructions, are used for this. Air locks for stairwells improve the safety of the escape route by adding extra protection. Starting from a threshold value of 50 metres for buildings (the floor level of the highest storey where people are present) and an average storey height of 3.2 - 3.5 metres for non-residential buildings, the 15-minute evacuation time is based on stairwells being guaranteed to be available for approx. 15 storeys. In other words: one minute is available for every individual storey. For fire evacuation purposes, stairwells of buildings that exceed this threshold value of 50 metres must be additionally protected by means of air locks. Starting from the maximum threshold of 70 metres and an average storey height of 3.2 - 3.5 metres for non-residential buildings, this would equal approx. 20 storeys being made safe for the available 15-minute evacuation time. The 5-storey (= 5-minute) difference is compensated for by having stairwells where extra protection is provided by air locks. In the 2003 Dutch Building Decree, the threshold value for an air lock to be required was 50 metres (floor level of highest storey where people are present). This air lock is necessary to enable timely evacuation and fleeing in case of a fire. The threshold value was lowered to 20 metres in the 2012 Dutch Building Decree further to a request from the fire services, as this would more effectively support repressive fire fighting. The threshold value for the necessity of a dry riser for fire suppression, a fire service lift and an air lock is the same and is also 20 metres.
- *Home evacuation time.* The time to evacuate an individual home is 1 minute.
- *Group 3, in-house emergency responders.* Group 3 requires special attention due to people's inability to leave without assistance. This must be compensated for by the in-house emergency responders. The scope of activities carried out by in-house emergency responders is not identical to that of an in-house fire service and furthermore the in-house emergency responders have not been trained and equipped with the means to act in the same circumstances as the fire service. Given their limited education and equipment, they are not expected to enter a burning room or a room filled with smoke that they cannot see through in order to rescue a person, unless the fire is still in such an early stage that the temperature and smoke in the room allow this. Here, the in-house emergency responders will evacuate the building and the fire service will rescue any people that may still be endangered. In other words: in-house emergency responders are not fire service personnel. In-house emergency responders are not expected to



Group 1: can leave without assistance; non-residential buildings

Group 2: can leave without assistance, sleeping; non-residential buildings

Group 3: cannot leave without assistance, sleeping; non-residential buildings

Group 4: can leave without assistance, sleeping; residential buildings and homes

venture into dangerous and unsafe circumstances where there is thick smoke, poor or no vision, heat, and where the fire is spreading. One should be aware that the use of respirators under dangerous circumstances requires specific competences, such as are applicable to firefighters. The use of respirators by in-house emergency responders in dangerous circumstances is not advised. However, they may be used in circumstances where there is no danger. This would be a technical use, e.g. to guide the fire service. However, the question remains whether this is actually necessary. The basic assumption is that where in-house emergency responders act as guides they will accompany the firefighters as far as the border of the unsafe area and keep themselves available there.

## Surroundings

Not applicable

### Architectural measures and facilities

The strength of the load-bearing structure of a building must be such that the structure will not collapse within a short time, ensuring that the available escape routes in the building stay intact and can be used by the people in the building, in spite of the fire.

A building must be divided into smoke compartments such that people are not forced to walk through smoke for too long.

Note:

- *There is a direct link between smoke compartments and the maximum permissible walking distances in buildings.*
- *It has been assumed that remaining in a smoke-filled room for more than thirty seconds is not permissible. The assumption that people can hold their breath and can cover a certain distance through the smoke on foot for this period of time is a realistic assumption. A walking speed of approx. 1 metre per second can be assumed for able-bodied people.*
- *A smoke-free escape route will be available for longer if the smoke is removed, for example by means of a smoke and heat ventilation system. If the building design assumes longer walking distances, a sufficient safety margin must be applied.*

A building should be divided into fire compartments such that they contribute to the safety of people in other parts of a building.

Note:

*The objective of a fire compartment is to restrict the possible unimpeded spread of a fire to a certain part of the building, such that a possible fire can be kept under control. If a fire is contained within the fire compartment, this will contribute to the safety of people in other parts of the building.*

The number of exits from a room in a building and where these exits are located, as well as the total width of the exits to be used, must be matched to the number of people that may be present in the room and to the extent of the fire hazard in the room.

Note:

*Based on common statutory requirements, the locations and sizes of exits will be sufficient for safe evacuation in many situations.*

*Special attention is required for situations where:*

- *wheelchairs and beds are used to transport people*
- *occupancy by people is extremely high or is beyond the scope of the applicable regulations.*

The fire resistance of partitioning constructions of rooms in which people are present who may be sleeping must be such that these people are not endangered by fire in another room.

Note:

*Here, it has been assumed that the fire must not escape from a pre-defined room within a period of 30 minutes. Examples of such rooms are:*

- *patient rooms in a healthcare building; patients and clients must not be endangered by fire in another room*
- *cells in a building that houses cells; inmates must not be endangered by fire in another cell or another room*
- *rooms in a guest accommodation building (e.g. a hotel room); guests must not be endangered by fire in another room.*

*An alternative value for the 30 minutes: fire resistance at least equal to the fire load expressed in kilograms of pine wood per m<sup>2</sup> of floor surface.*

In principle, people in a building should be guided to a safe place from a room in two directions, i.e. the 'escape routes', directly or only by way of floors, stairs and ramps.

\*) for residential buildings

Note:

*Here, 'in principle' refers to some, be it very few, possible exceptions, e.g. if walking distances are very short.*

In principle, in buildings with people who cannot leave without assistance, these people have to be moved horizontally to a safe sector (i.e. another fire compartment as the evacuation sector). Examples of such buildings are a healthcare building and a building that houses cells.

Note:

*Fire may lead to a situation where horizontal movement is not possible since only one side of the fire compartment borders on another fire compartment. There will then be an emergency exit (stairs or exit that leads directly outside) on the other side. This is a complicating factor that the in-house emergency responders must take into account, particularly in healthcare buildings with people who are not able to leave without assistance.*

Every room in a home should have at least one escape route that is straightforward and logical and that leads along a reasonably safe route of the shortest distance possible.

The number of escape routes and how they are situated, the locations of the exits, the widths of the escape routes and exits must be matched to the number of people who use them 'simultaneously', as well as to the degree of the fire hazard in the building.

\*) for residential buildings

Note:

*Based on common statutory requirements, the locations and sizes of escape routes will usually be sufficient for safe evacuation.*

*The following situations require special attention:*

- *If wheelchairs and beds are used to transport people, e.g. in healthcare buildings.*
- *If several rooms are used at the same time, due to which flows of people moving in opposing directions will have to be prevented from occurring, e.g. in certain public buildings, conference centres and bars and restaurants.*
- *High occupancy. As regards evacuation, it must be taken into account that, once a crowd has started to move, it must not be slowed down too much as this might result in panic, leading to casualties as people may be trampled underfoot.*

The combustibility of the construction elements must be limited such that the risk of fire propagation and smoke development is sufficiently small, given the intended use of the room where such construction elements are used.

Note:

*Restricting fire propagation and smoke development on the non-heated side of walls is an area that requires special attention. This specifically applies to situations where walls demarcate the escape routes.*

Group 1: can leave without assistance; non-residential buildings



Group 2: can leave without assistance, sleeping; non-residential buildings



Group 3: cannot leave without assistance, sleeping; non-residential buildings



Group 4: can leave without assistance, sleeping; residential buildings and homes



Doors in an escape route must be able to be opened without a key or another loose object and must, in principle, not open in the opposite direction to the evacuation direction.



Note:

- Of course, this does not apply to rooms intended for people to be locked up in them.
- The opening direction depends on how many people have to use the door.

The building should have effective escape route signage.



Note:

This may possibly be combined with emergency lighting systems.

While evacuating the building, people should not be hindered by falling glass.



### Technical systems

The building should have an effective lighting/emergency lighting system.



#### Additional information for buildings that house cells

A building that houses cells should have an effective communication system in order to inform the inmates.



Note:

This is the system that provides the speaking/listening connection between the guards and the cells or a similar system with sound transmission. This system can be used to convey messages, and so can also be used in the event of a fire. Information provision by way of the system should be such that information is provided from a central point and individual inmates or groups of inmates can hear what is going on and how to act. This may be achieved by providing the communication system with instructions to be issued via a pre-recorded message, if necessary in several languages if the inmates do not understand Dutch well enough.

### Fixtures and fittings

The fixtures and fittings in the building must not significantly contribute to the fire growth and the occurrence of smoke. Examples are upholstery, furniture, mattresses and bed linen.



#### Additional information for industrial buildings

The construction of machines, tools and process or other equipment must be such that they will not cause major fire and smoke development.



#### Additional information for public buildings

The construction and furnishing of vehicles (buses, trains and underground trains) must be such that they will not cause rapid fire and smoke development in the event of a fire.



### Occupancy

Escape routes must be kept clear from obstacles, stored goods and combustible goods.



The equipment and other fixtures and fittings must be placed such that they do not impede timely evacuation and fleeing.



Staff, guests, residents, clients, i.e. the people at risk, must be aware of the fundamentals of the evacuation plan.



Instruction and education play an essential role in the 'residential use' sector. Some areas that require special attention for residents:

- Make sure you have an evacuation plan.
- Limit the amount of combustible materials in homes. This particularly applies to corridors, lobbies and doorways.
- Keep interior doors, especially the doors to the living room and the kitchen, closed, at least at night.
- Close windows and doors in the event of a fire.
- Prepare evacuation possibilities, especially if a home has certain rooms which are hard to flee from.
- Sometimes it will not be possible to flee from a fire while walking upright. The chances of escaping safely are better closer to the floor, possibly by crawling, since temperatures are lower and there is less smoke.
- Before opening any doors, make sure that there is no fire behind the door (warm or hot door). If you do have to open the door anyway, stay low (crouch or bend down) and avoid being directly in front of the door as much as possible.
- Remember that some people, especially children, may hide under a bed or in a cupboard or flee into the toilet, etc. out of fear of the fire.

### **In-house emergency response organisation**

There must be an effective evacuation plan that is aligned to the fire service's plan of attack.

Areas that require special attention as part of the evacuation plan are:

- The order in which rooms containing people will be evacuated. This is mainly important for buildings of group 3. When bringing people in such buildings to safety, a system with a structured order must be applied. The basic sequence of evacuation is:
    - from the room with the fire (e.g. patient room or cell) to a safe location and then
    - from the endangered area (e.g. fire compartment) to a safe location
- Explanation, specifically for group 3:  
A safe location is a room in the building, or a location outside the building, with sufficient capacity to accommodate the number of people in question.  
The safe location must be guaranteed to be free from fire, smoke and heat radiation, such that the people involved do not see the fire. If the safe location is indoors, it will, in the first instance, be another fire compartment.
- Knowing how many people have to be evacuated.
  - Specifically for buildings with people who can leave without assistance:
    - if there are some people who suffer from a disability or impediment due to which they need the help of others to get to safety, the organisation must correspond to this.
  - Specifically for healthcare buildings:
    - The organisation must correspond to the specific restrictions of the specific patients and/or clients.
  - Specifically for buildings that house cells:
    - The management of keys to enable the rooms where people are locked in to be unlocked.
    - Sufficient safe rooms (shelters) must be designated where inmates can be taken to.

*Note:*

- *The basis for an in-house emergency response plan is the risk assessment and evaluation that is necessary from a work safety perspective. The evacuation plan is part of the in-house emergency response plan. An in-house emergency response plan should include instructions as to suppressing an incipient fire and evacuating a building. Fire scenarios can be used in order to actually set up an in-house emergency response organisation, taking into consideration any architectural facilities and technical systems present.*
- *People who cannot leave without assistance rely entirely on the in-house emergency responders to evacuate them. In that event, an additional risk assessment and evaluation, i.e. a specific fire safety analysis, will have to be carried out besides the regular risk assessment and evaluation in order to set up an effective emergency response organisation (see also section 4).*

Group 1: can leave without assistance; non-residential buildings	■
Group 2: can leave without assistance, sleeping; non-residential buildings	■
Group 3: cannot leave without assistance, sleeping; non-residential buildings	■
Group 4: can leave without assistance, sleeping; residential buildings and homes	■

- To be able to set up an effective emergency response organisation, a specific fire safety analysis must also be carried out in high-risk buildings, such as buildings with high occupancy combined with rooms used for multiple purposes.
- To avoid all ambiguity, a reference document with the typical scenarios should be available for every sector or for every type of building, since scenarios determine the standards for setting up the in-house emergency response organisation. The evacuation plan may be part of a bigger whole, the company emergency plan.

The basic assumptions underlying the division of the normative fire development into phases (see section 1) have to be complied with.

Drills to practice the evacuation plan should be carried out on a regular basis.

The in-house emergency responders and the staff should know what to do in the event of a fire.

Note:

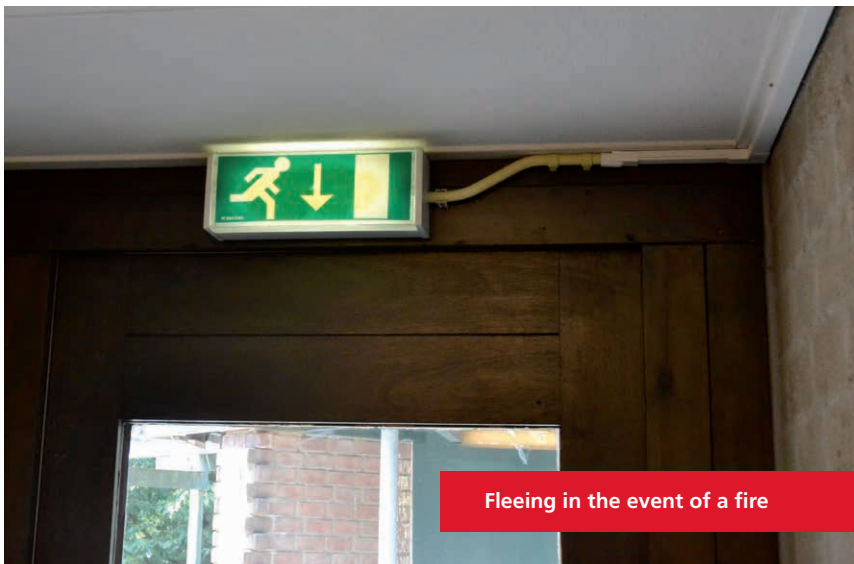
- Instruction about and drills in using the evacuation plan and the circumstances in which it is used must be provided and must be repeated at regular intervals. Sometimes the staff perform subtasks as in-house emergency responders.
- Coordination and working together with the local fire service are important aspects of the drills. This particularly applies to high-risk and complex buildings, including those in group 3.

### Fire service

A plan of attack for the fire service must correspond to the evacuation plan for the building.

Note:

- The fire service's deployment must be prevented from stagnating.
- A specific requirement for cells and for buildings that house cells is that the fire service must not be deployed before the evacuation has been completed (to avoid hostage situations).



Fleeing in the event of a fire

## 2.5 Action by the in-house emergency responders, staff and residents to extinguish an incipient fire

- Group 1: can leave without assistance; non-residential buildings ■
- Group 2: can leave without assistance, sleeping; non-residential buildings ■
- Group 3: cannot leave without assistance, sleeping; non-residential buildings ■
- Group 4: can leave without assistance, sleeping; residential buildings and homes ■



Extinguishing an incipient fire

Detailed classification of the safety objective:  
Using fire extinguishing equipment, such as a portable fire extinguisher, a fire blanket and a fire hose reel, to extinguish an incipient fire.

Area that requires special attention:  
The interaction between extinguishing the fire and evacuation: what should be done first, and under what circumstances?

**Surroundings**  
Not applicable

**Architectural measures and facilities**  
Not applicable

**Technical systems** ■ ■ ■  
There must be effective fire hose reels in the building.  
*Note:*

- Certain rooms, such as technical rooms, laboratories, workshops and kitchens, require effective portable fire extinguishers to be available in addition to the fire hose reels.
- The decision as to whether fire hose reels and/or portable fire extinguishers are necessary depends on the results of a risk assessment.

**Fixtures and fittings**  
Not applicable

**Occupancy** ■ ■ ■  
Members of staff have to be aware of the user instructions for the fire extinguishing equipment.

Fire extinguishing equipment must always be easily accessible, i.e. the fixtures and fittings must not impede their accessibility. ■ ■ ■

Residents must also be instructed as to the following subjects: ■

- They should be aware of practical indoor fire extinguishing methods, such as by covering the flames (e.g. when the contents of a cooking pan catch fire), and of how to use garden hoses, portable fire extinguishers or fire blankets.
- Any efforts by the residents to put out a fire in a home must not delay their reporting the fire to the fire service.

**In-house emergency response organisation** ■ ■ ■  
The in-house emergency responders must have practised the use of the fire extinguishing equipment that is available.

The tasks assigned to the in-house emergency responders as regards suppressing an incipient fire must be determined on the basis of the expected fire scenario. ■ ■ ■

Instruction and practice in how to use fire extinguishing equipment is necessary and must be repeated at regular intervals. ■ ■ ■

**Fire service**  
Not applicable

## 2.6 Automatically suppressing a fire as quickly as possible

Group 1: can leave without assistance; non-residential buildings	■
Group 2: can leave without assistance, sleeping; non-residential buildings	■
Group 3: cannot leave without assistance, sleeping; non-residential buildings	■
Group 4: can leave without assistance, sleeping; residential buildings and homes	■



Detailed classification of the safety objective:

Automatic fire suppression is a protection option that should definitely be considered for high-risk and complex buildings. The fire scenarios can be influenced by automatic fire suppression, enabling the normative fire scenario to be scaled down compared to a scenario that does not provide for automatic suppression. A properly designed and maintained sprinkler system is capable of extinguishing a fire or keeping it under control. Automatic suppression leads to early intervention in the events that play a role in a fire, resulting in less severe consequences as the impact of a small fire is less than that of a major fire. In the event of a fire, automatic suppression makes a positive contribution to improved time, temperature and smoke conditions and, as a result, to the safety of the people in a building, including any emergency responders. Providing automatic fire suppression enables optimum account to be taken of the vulnerability of human actions during a fire situation. This latter consideration is specifically important in buildings occupied by people who cannot leave without assistance.

Residents of homes who receive extramural care are part of the ageing population in which the tendency is towards deterioration in ability to leave without assistance. Early fire suppression is important here as well, in this case using sprinklers for residential environments.

Due to a change away from the repressive intervention perspective, the fire service has become more reluctant to attack inside a building. This specifically applies to situations where no people have to be rescued and the adjoining buildings do not run any risks (see also sections 2.8 - 2.11). Early suppression using a sprinkler system is important if:

- an owner/occupant wants to keep the building intact in order to contain the damage and/or to prevent their business operations from being interrupted
- the fire service thinks that fighting the fire inside the building is no longer possible and the building's collapsing would lead to problems for its surroundings. An example of this is an underground parking garage with a building on top of it.

In-house emergency responders in group 3 buildings must be able to compensate for the inability of people to leave without assistance. In such events, the endangered area does not need to be evacuated if the fire is suppressed or contained automatically. However, evacuating people from any rooms where there is fire continues to be necessary.

*There is a relationship between the 'automatic suppression' method and the set-up of the in-house emergency response organisation:*

- The risk assessment and evaluation, required for work safety, forms the basis for an in-house emergency response organisation. Attention to fire is an integral element of this. An important aspect to consider is which tasks to assign to the in-house emergency response organisation. The protection option of 'automatic suppression' in a building can be realised by performing both a risk assessment and evaluation and an additional fire safety analysis (see also section 4).

*This method requires that special attention is paid to the following aspects:*

- From the point of view of cost effectiveness during a building's lifecycle, the lump sum costs of investment in the automatic fire suppression systems should be compared to the long-term management costs that would otherwise be incurred by the organisation for the relevant sub-area of fire protection. When considering the long-term management costs for the organisation, the costs of a large or heavily equipped in-house emergency response

organisation should be compared to those of a smaller and/or less heavily equipped one.

- There is a relationship between the use of the protection option of 'automatic suppression' and the fire safety balance (see section 3), the possible consequence of which is that, based on a risk assessment, less strict requirements may apply to other types of fire protection facilities.
- There is a positive relationship between the use of the protection option of 'automatic suppression' and damage reduction and the continuity of an institution's or company's operations.

#### Alternative protection options in the context of extinguishing fires



The number one option for automatic fire suppression is an automatic sprinkler system, mainly since this is a tried and tested technology that has proved its worth for many years. This does not imply that other types of fire extinguishing systems that serve the same purpose are not useful and cannot be applied.

In the context of the principle of equivalent fire safety there is the opportunity of applying alternative protection options. This also applies to alternatives of the protection goals of 'automatically suppressing fire as quickly as possible'. If the alternative involves a different type of system that provides automatic fire suppression, this will have to be judged on its merits.

An example of an innovative system is a water mist suppression system. Another innovative option is a suppression system that must be activated manually in order to extinguish or contain fires in prisons. Although this is not strictly automatic fire suppression, this facility may help provide an adequate fire safety level. Innovative facilities do require that their applicability is studied.



Automatically suppressing a fire



## 2.7 Reporting a fire as quickly as possible

Group 1: can leave without assistance; non-residential buildings	■
Group 2: can leave without assistance, sleeping; non-residential buildings	■
Group 3: cannot leave without assistance, sleeping; non-residential buildings	■
Group 4: can leave without assistance, sleeping; residential buildings and homes	■

Detailed classification of the safety objective:

Reporting a fire to the fire service in order to inform the fire service about a fire. Fires can be reported as follows:

1. directly to the central control room of the emergency services. Possible method:
  - manually (e.g. by phone)
  - automatically through a fire protection system (e.g. a fire alarm system and/or a sprinkler system)
2. through another control room (e.g. a commercial control room).

For reporting times: see the phases identified for normative fire development in section 1.

*Note:*

*To prevent the fire service from turning out unnecessarily, a commercial central control room must ensure proper verification of reported fires before passing them on to the fire service.*

### Surroundings

Not applicable

### Architectural measures and facilities

Not applicable

### Technical systems

The fire alarm system and the automatic fire suppression system should report directly to the central control room of the emergency services.

\*) for the time being this applies to hotels without 24/7 monitoring by staff. The Dutch fire services have agreed with the Dutch Ministry of the Interior and Kingdom Relations that this direct reporting to central control rooms will be maintained for this category for the time being, as studies have shown that guests in hotels without 24/7 monitoring fail to properly respond to a fire alarm, and in practice, the fire service does not know whether the hotel has been evacuated. As soon as hotel owners have made sufficient investments in facilities to ensure effective alarm response by hotel guests, the requirement for the local systems to report directly to a central control room will be cancelled here as well.

*Notes:*

*Both the fire service and the in-house emergency responders are often confronted with false alarms by fire alarm systems that directly report to the central control room of the emergency services. The percentage of false alarms by fire alarm systems is approximately 95%, based on all types of buildings. This high percentage affects the mindset of the internal organisation and the fire personnel, resulting in a longer reaction time and slower turnout speed. Furthermore, false alarms lead to problems for the fire service in the form of:*

- less capacity to be deployed for real fires elsewhere
- traffic being jeopardised unnecessarily
- unnecessarily high extra costs.

*Attempts to effectively solve the problem of false alarms have been unsuccessful in the past. If no further action is taken, these problems will continue to exist.*

### Project to reduce unnecessary turnouts

The former Dutch NVBR and the Fire prevention professorship of the Netherlands Institute for Safety (NIFV) carried out a study in order to try and reduce the number of false fire alarms by fire alarm systems that directly report to a central control room. The study report, entitled 'Nodeloze uitrukken terugdringen (NUT)' (Reducing unnecessary turnouts) was published in February 2011. One of the conclusions of the report is that the current number of false alarms can be reduced by 54% without compromising the fire safety level. This reduction could mainly be achieved in the sectors of buildings with people who can leave without assistance. The report contains some recommendations for improvements. As a follow-up to the NUT project, the NVBR drew up the 'Handreiking Terugdringen Ongewenste en Onechte Meldingen' (Guidelines on reducing undesired and false alarms) (TOOM, March 2012). The NVBR has drawn up these guidelines to provide the fire service regions and fire brigades with practical information and examples in order to help them further reduce the number of false alarms by systems that must have direct reporting to an control room. Through these guidelines, the NVBR has also contributed to more uniformity in the approach to reducing the number of false alarms.

Reporting a fire requires that there is a phone in or near the home. Extra phones in one or more bedrooms are advisable. The basic assumption is that any telephone lines have been constructed such that they will not be affected too quickly by fire.

Fire alarm systems that report to a commercial control room should offer sufficient quality guarantees to ensure that any fire alarms are reliable and will be handled properly.

### Fixtures and fittings

Not applicable

### Occupancy

When work that poses a fire hazard, such as welding, flame cutting and roofing, etc., is carried out, a qualified expert must supervise such work at all times.

Residents and staff are to be instructed as to how to report a fire to the central control room. They should learn which information is important for the control room. The parties involved have to know that 112 is the emergency number and which information to provide: the town or city and the address where there is a fire.

*Note:*

*The objective is that their behaviour is structurally focussed on reporting the fire to the central control room of the emergency services as quickly as possible.*

Staff must be instructed and trained so that their behaviour is structurally in compliance with rapidly reporting a fire to the central control room of the emergency services. See the text directly above as well.

### In-house emergency response organisation

In-house emergency responders must be instructed and trained so that their behaviour is structurally in compliance with rapidly reporting a fire to the central control room of the emergency services.

*Note:*

*This concerns aspects such as being familiar with the procedure to be followed when reporting a fire to the central control room and the correlation between the fire alarm system and the automatic fire suppression system.*

The basic assumptions underlying the division of the normative fire development into phases have to be complied with.

- Group 1: can leave without assistance; non-residential buildings ■
- Group 2: can leave without assistance, sleeping; non-residential buildings ■
- Group 3: cannot leave without assistance, sleeping; non-residential buildings ■
- Group 4: can leave without assistance, sleeping; residential buildings and homes ■

**Fire service**

The internal organisation of government and commercially operated control rooms involved in fire alarms and their mutual coordination should be set up to the aim of achieving an optimum speed and efficiently gathering information about, and verifying, fire alarms. The quality of the control rooms should be monitored and improved where necessary.



Reporting a fire to the fire service

## 2.8 to 2.11 Intervention by the fire service as quickly, safely, and effectively as possible

Group 1: can leave without assistance; non-residential buildings	Dark Blue
Group 2: can leave without assistance, sleeping; non-residential buildings	Light Blue
Group 3: cannot leave without assistance, sleeping; non-residential buildings	Red
Group 4: can leave without assistance, sleeping; residential buildings and homes	Orange

Detailed classification of the safety objectives:

There are dynamic relationships between the various protection objectives of responding (2.8) and attacking (2.9) by the fire service, and the fire service rescuing people (2.10) and extinguishing fires (2.11). These relationships manifest themselves during the intervention time. These relationships are the reason why the protection objectives 2.8 - 2.11 have been combined. This also applies to the associated areas that require special attention. As the fire protection of buildings is the central theme of this document, the dangers caused to the environment when fires are extinguished are not considered in these areas.

Explanation:

Strict basic assumptions for defining the time phases for the protection objectives 2.8 - 2.11 related to risk management in buildings are neither useful nor possible, save for the times stated in the sub-division into phases of the four groups of buildings identified in section 1 of this chapter (see section 4 of chapter 1 for further information on intervention time).

The method of attack is related to the fire service's intervention perspective. This intervention perspective has actually been subject to constant changes in the past few years and is now evolving quite distinctly from a default, standard approach to bespoke intervention.

*Basic fire service units*

For many years, a standard response unit of the Dutch fire service consisted of one water tender and a crew of six. In the 1980s, this was a crew of eight and a few years earlier a crew of nine. The introduction of walkie-talkies heralded the end of the position of orderlies and as the fire appliances (water tenders) also started to carry their own water, 'hose crew' were no longer needed either. These six people enabled the fire to be fought inside the building by two crews. In most situations, that sufficed to perform the tasks of rescuing people, and containing and extinguishing the fire. And if this did not suffice, the attack would be scaled up by more units comprising one water tender and a crew of six.

However, in recent years it has become clear that fire fighting can be organised more effectively and more efficiently. Experiments are also being carried out in countries surrounding the Netherlands and some of these countries have been working with flexible response sizes and standby crew sizes in fire stations for some time now. For example, there are more fire appliances and personnel in fire stations in the city centres in the daytime, but this changes at night, when the majority of appliances and personnel are relocated to residential and entertainment districts. Some countries are even experimenting with manned fire appliances positioned in varying strategic locations instead of usually being kept in the fire stations. In the Netherlands, this system is only used at events that draw large crowds.

Flexible standby intervention crews at fire stations do not exist in the Netherlands yet, but the fire appliance crews already vary in some circumstances. An appliance is no longer always manned by a standard crew of six, but it may also be manned by a crew of four or two for example. Various studies by the Dutch safety regions have shown that lots of fires can also be extinguished by smaller appliances with fewer personnel. This enables more flexibility and efficiency (also if an intervention is scaled up), and, if fire stations depend on volunteers for turnouts, a shorter mobilisation time.

Group 1: can leave without assistance; non-residential buildings	■
Group 2: can leave without assistance, sleeping; non-residential buildings	■
Group 3: cannot leave without assistance, sleeping; non-residential buildings	■
Group 4: can leave without assistance, sleeping; residential buildings and homes	■

At present, the system of variable appliance crews is a subject of debate. The people who advocate this system see the advantages that flexibility offers in order to make sure that the fire service organisation will also stay sufficiently strong in the future. For the fire protection of buildings it will then be necessary that the variable response size is properly matched to the normative scenarios of the building, i.e. via a good risk assessment of building, fire and human characteristics. This requires relevant knowledge of fire prevention from the people who decide on the response size. Those who are opposed to this system think that the fire service should not prepare for normative scenarios but for maximum scenarios and they therefore see the variable appliance crews as compromising the quality of fire fighting and as a cost-cutting measure. However, the discussion about variable appliance crews had already started in the Netherlands before there was any need for the Dutch government to cut their spending.

#### *Attack inside a building*

The fire at De Punt on 9 May 2008, where three firefighters lost their lives, caused the fire service to reconsider its attack strategy, which at that time actually only consisted of an 'indoor attack' which meant that, upon arriving, the firefighters entered the burning building to fight the fire. The arrival of high-pressure fire extinguishing equipment and respiratory devices enabled this strategy to be developed in the 1960s after which it was continuously perfected. However, the risks of fighting fires in buildings increased in recent years, partly due to the increased use of plastics in building and furnishing materials. After the fire at De Punt, people realised that more fire fighting alternatives had to be made available. In theory, there was already an alternative in the form of attacking from the outside, but in fact what this boiled down to was letting the building burn down in a controlled manner.

Several tactics have now been developed, based on the '4-quadrants model'. Based on the parameters of indoor attack, outdoor attack, offensive attack and defensive attack, four options have been developed and elaborated into considerations and conditions for the head fire officer on site. See figure 50 for the 4-quadrants model.

Although the development of several attack options was inspired in order to improve safety for fire service personnel, this is by no means its only objective.

For example, studies have shown that an offensive outdoor attack produces better results for survival conditions (by influencing temperature, oxygen content and CO concentration) of people still in the building, and produces such results faster, than offensive indoor attack. This provides the fire service with more time to rescue people from the building in time.

Besides the fire characteristics, the building characteristics and the human characteristics also play a role when deciding on the type of attack. This is a very important step in determining the relationship between fire prevention and repression and it has created a direct relationship between the choice of the fire fighting method and the other repressive tasks such as evacuation, rescuing and preventing the fire from spreading, and the risk classification of buildings into groups 1 to 4.

A scientific substantiation of these attack options and the development of the necessary technical aids will be drawn up in the near future. The extinguishing medium also plays an important role here. As water is no longer always the obvious choice, the need of extinguishing water will also be reviewed.

Building regulations consider the deployment of the fire service in order to fulfil the basic principles that people should be able to leave a building safely and that any adjoining buildings must not be damaged. The 4-quadrants model does not change this. The task of rescuing is still performed and has never been a problem. The problem that led to the development of the 4-quadrants model was that most firefighters who died in action were killed while carrying out activities to limit damage. The other basic principle, i.e. that any adjoining buildings must not be damaged, is now better supported from a repressive point of view since the 4-quadrants model provides for a scientifically substantiated tactic for the defensive outdoor attack aimed at protecting adjoining buildings.

Fire prevention measures and facilities play an important role in being able to choose the type of attack and successfully completing the attack. For example, fire resistant partitions play a crucial role in a defensive indoor attack. The attack is then aimed at limiting the fire to the fire compartment or the sub-compartment. The recognisability and reliability of the fire compartments are essential then. The behaviour of building structures and materials has also started to play a more explicit role. Although this is not always essential to the people who are fleeing from the building, compliance with the requirements is vital to the firefighters who are in the burning building later and longer.

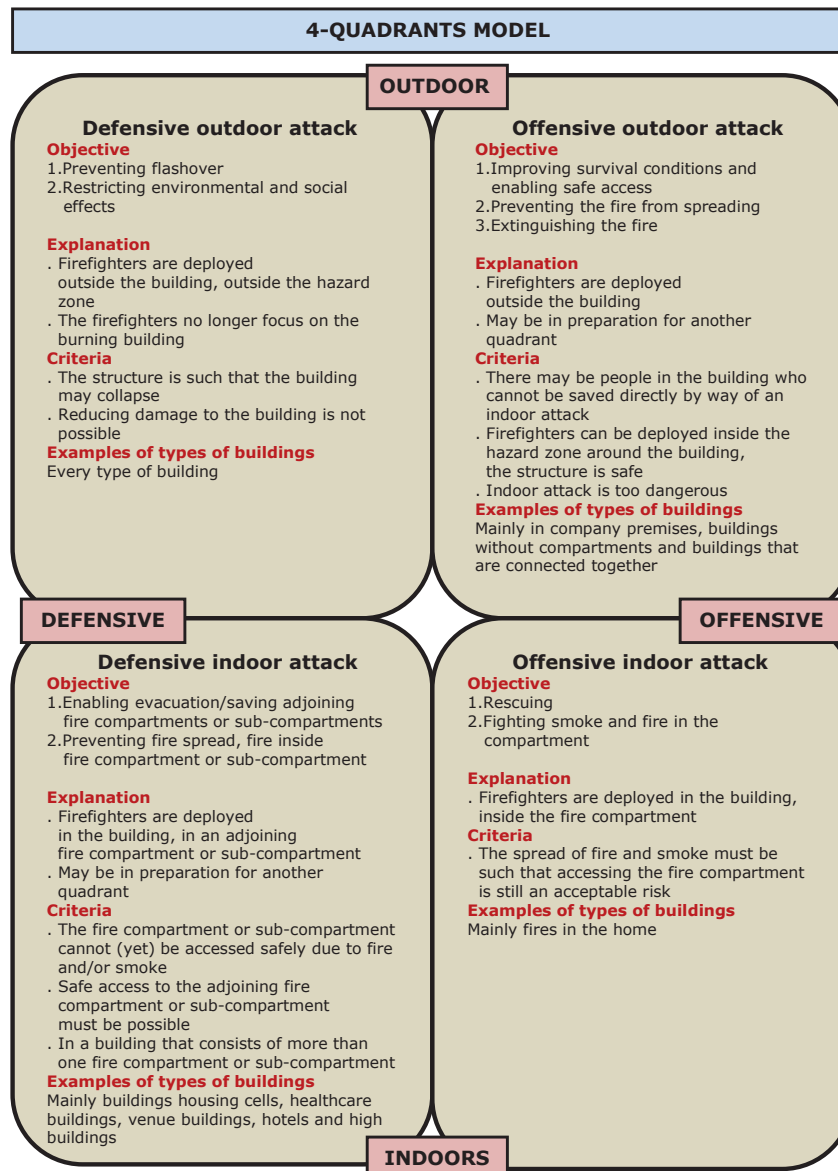


Figure 50 4-quadrants model

Group 1: can leave without assistance; non-residential buildings	■
Group 2: can leave without assistance, sleeping; non-residential buildings	■
Group 3: cannot leave without assistance, sleeping; non-residential buildings	■
Group 4: can leave without assistance, sleeping; residential buildings and homes	■

*Risk approach in the event of repression*

In response to market demands, the application of risk approach has made fire prevention an increasingly bespoke solution. The same thing now goes for fire fighting. This is stimulated by the government. 'Bespoke' here means carefully weighing all options, while considering an integral solution. A bespoke solution for repression now already includes considering whether or not to directly report an automatic fire alarm to a central control room, considering where the statutory response times may be exceeded, or where shorter response times are necessary. This also means identifying which appliance crews are possible and necessary. Add to this the options of outdoor or indoor attack and an offensive or defensive intervention tactic and it will be clear that repression is now also all about scenarios and risk approach.

**Surroundings**

As regards the fire service responding, it has been assumed that the fire stations are located such that timely intervention by the fire service is possible.



Responding by the fire service requires the fire service's permanent attention to the traffic infrastructure. Solutions that serve both general traffic safety and a quick response by the fire service have to be found.



As regards response by the fire service, it has been assumed that good accessibility is assured.



As regards deploying the fire service, it has been assumed that a hose line to the building entrance closest to the fire can be constructed from the location where the fire service sets up its equipment within a short time of arriving at this location. See also section 3.2 for further information on providing facilities that increase the speed of intervention, such as fire service lifts and dry risers.



*Note:*

*A building's complexity and nature are important factors for determining the number of emergency exits and other exits. Every exit or emergency exit is also a way in. Since it is not known in advance where a fire may occur, every entrance may be the entrance closest to the fire.*

As regards the deployment of the fire service, it has been assumed that the first basic unit (fire extinguishing unit) can be connected to an extinguishing water facility of sufficient capacity and sufficiently long usage duration, within a short time of their arrival at the location where they set up their equipment.



**Architectural measures and facilities**

To enable the fire service to be deployed, gates, subways, fences and other kinds of structures on the access route to the building must comply with the regular dimensions applicable to such structures on public roads to enable fire appliances to get near the building.



To enable the fire service to be deployed, and to enable them to rescue people and extinguish the fire, the main load-bearing structure of a building must be of a sufficient strength to prevent the structure from collapsing within a certain time in the event of a fire. This ensures that the routes of attack in the building remain intact and can be used by the fire service in spite of the fire.



To enable the fire service to be deployed, and to enable them to rescue people and extinguish the fire, the routes of attack in a building have to comply with the same architectural principles as described in section 2.4.



To enable the fire service to be deployed, and to enable them to rescue people and extinguish the fire, a stairwell that forms part of a route of attack must be free from fire and, to the extent possible, smoke for as long as the fire service uses the stairwell in question in order to extinguish the fire.



*Note:*

*Since it is not known in advance where a fire may occur, any escape route might serve as a route of attack.*

Rooms where hazardous materials are located, and where the danger is such that these rooms cannot, or cannot immediately, be entered by the fire service, must be enclosed such that any fire in such rooms cannot spread further and that a fire in the surroundings cannot affect these rooms. Examples of such rooms are: rooms where spray cans with combustible aerosols, radioactive materials and/or fireworks are stored.



For a fire to be extinguished by the fire service, a building must be divided into fire compartments such that the fire service is able to get a fire in a fire compartment under control within 60 minutes of the fire starting.



The fire resistance of the partitioning structures between a fire compartment and the other parts of the building, expressed in minutes, must as a minimum equal the fire load expressed in kilogrammes of pine wood per m<sup>2</sup> of floor surface.



### Technical systems

Good radio communications or other forms of communication among the different fire service units and the central control room must be guaranteed for the fire service to be deployed inside a building.



*Note:*

*The fire service's own means of communication will usually suffice. If they do not work sufficiently well in a certain building or structure, a provision must be made in the building or structure that has the envisaged effect on the operation of the customary means of communication.*

Deployment of the fire service may require the entrances of a building specifically for the fire service to be communicated to the fire service by means of an optical signal that is connected to the fire alarm system and/or automatic sprinkler system.



*Note:*

*The need of the facility is related to a complex situation where, for example, the grounds contain many buildings and/or where it is not clear how to access a complicated building. The objective of the optical signal is to enable the fire service to find the right entrance in the most efficient time.*

### Fixtures and fittings

Deployment of the fire service requires that the fixtures and fittings, such as storage racks, are sufficiently stable.



### Occupancy

As regards the deployment of the fire service, it has been assumed that the fire service can make use of locations that have been reserved for them and where they can set up their equipment.




As regards the deployment of the fire service it has been assumed that the fire service has an effective plan of attack for complex and/or high-risk buildings.






- Group 1: can leave without assistance; non-residential buildings 
- Group 2: can leave without assistance, sleeping; non-residential buildings 
- Group 3: cannot leave without assistance, sleeping; non-residential buildings 
- Group 4: can leave without assistance, sleeping; residential buildings and homes 


**In-house emergency response organisation**

As regards the deployment of the fire service, it has been assumed that, if there are people in the building, the in-house emergency response organisation has been set up such that the fire service will be met upon their arrival, admitted into the grounds, and provided with the relevant information (in-house emergency responders acting as a first response unit). Any access doors, gates and fences should have been opened. 


As regards the deployment of the fire service, it has been assumed that the staff will take action in good time to clear the route of attack for the fire service. 

*Note:*


*The security facilities that are related to the fire service's ability to act in good time and safely require special attention. Examples of this are door locking systems in buildings that house cells, mental healthcare institutions, banks and law courts. Here, specific attention should be paid to access to grounds and complexes that have corridor-like controlled access facilities for vehicles.*

As regards the deployment of the fire service, it has been assumed that staff must be instructed and trained so that their behaviour is structurally in compliance with the objective of achieving fast deployment of the fire service. This training and instruction must be repeated at regular intervals. This requires that the in-house emergency responders and the local fire service work together. 

**Additional information for buildings that house cells**


As regards the deployment of the fire service, it has been assumed that the personnel of a building that houses cells takes timely action to clear the fire service's route of attack from inmates. 


**Fire service**

To enable the fire service to turn out, the traffic may have to be controlled at the forecourt of the fire station and on the main routes leading to the scene of the fire. 

*Note:*

*Fire appliances may be fitted with means to control the traffic, e.g. to control the traffic lights on crossroads that are always busy.*

As regards the fire service responding, it has been assumed that the central control room has an effective alarm control system so that, if the first basic unit (fire fighting unit) is away, the nearest fire fighting unit is warned. 

To enable the fire service to be deployed, and to enable them to rescue people and extinguish the fire, it has been assumed that the fire service has an effective plan of attack. 

*Note:*

*A contingency plan for disasters may also apply to buildings in the industrial sector.*



The extinction of a fire by the fire service

## 2.12 Providing after-care as quickly and effectively as possible

Group 1: can leave without assistance; non-residential buildings

Group 2: can leave without assistance, sleeping; non-residential buildings

Group 3: cannot leave without assistance, sleeping; non-residential buildings

Group 4: can leave without assistance, sleeping; residential buildings and homes

Detailed classification of the safety objective:

The safety objective is restricted to preventing consequential damage or loss. Other forms of after-care, such as the after-care aimed at people, do not form part of this document.

It has been assumed that the repressive intervention by the fire service is such that preventing consequential damage or loss, including damage by smoke and water, is taken into account as much as possible.

It has been assumed that the fire service will inform the Dutch Salvage foundation about a fire if necessary.

*Note:*

The Dutch Salvage foundation takes measures to:

- limit damage and loss, including consequential damage and loss, as a result of a fire to the extent possible. This may be done by quickly taking some relatively simple measures, such as having extinguishing water removed, sealing windows where the glass has broken, and/or:
- advising and actively helping victims
- obtaining an understanding of the cause and extent of the damage as soon as possible.

### 3. Fire safety balance

The degree of fire safety in a building is determined by the combination of building characteristics, human characteristics, intervention characteristics and environmental characteristics. This combination can be compared to a pair of scales that should be in balance (see section 2). Figure 51 shows a diagram of a fire safety balance.

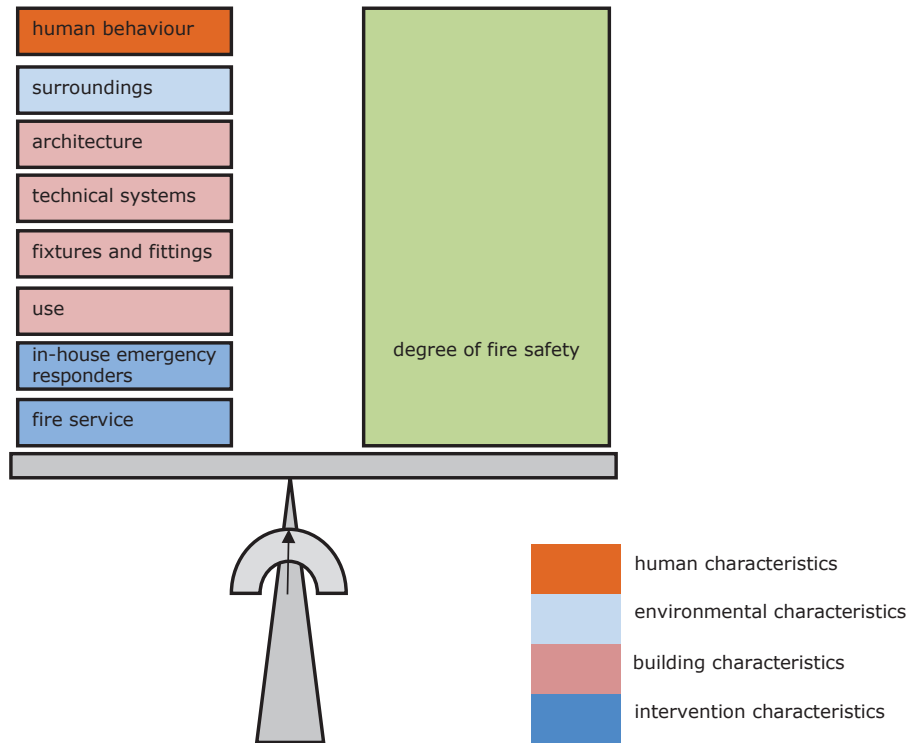


Figure 51 Fire safety balance

The combination of areas requiring special attention outlined in section 2 is closely related with the normative fire development phases already defined. If the height or size of a building is such that the basic assumptions listed in the normative fire development are not fulfilled, extra measures and/or facilities may have to be provided. These measures or facilities aim to positively influence the evacuation and intervention times. The combination of basic assumptions also enables choices to be made without disturbing the balance. These choices are made in the context of equivalent fire safety. For example, an automatic fire suppression system can help limit the extent of a fire and the amount of smoke. This substantially reduces the risks and creates reduction opportunities in other focus areas, such as architectural measures and facilities, and the in-house emergency responders. Influencing the evacuation time and influencing the intervention time are key aspects of the fire safety balance.

#### 3.1 Influencing the evacuation time

In principle, the evacuation time of buildings with people who can leave without assistance can be improved by:

- making stairwells safer (see 3.1.1)

- shortening the discovery time (see 3.1.2)
- automatically suppressing the fire almost immediately after it has started (3.1.3).

Effective deployment of the in-house emergency response organisation can also positively influence the evacuation time.

In general, the evacuation time is not determined by fire only, but this depends on the facilities, the layout and other relevant properties of the building. The evacuation time may also depend on the number of people who feel immediately endangered and, of course, also on the number of people who are actually endangered. The capacity required for the escape routes is determined by more factors than only fire. Possible internal or external causes that necessitate complete and quick evacuation, such as in the event of an imminent explosion in the surroundings or a bomb alert, should also be taken into account. This document does not go into these causes. In buildings with people in them who are not able to leave without assistance, the evacuation time cannot be influenced by the first two measures mentioned. In principle, people who have to be helped to evacuate from these buildings will not be able to leave the building in a vertical position. These buildings require a fire alarm system with full monitoring to be present as a basic facility. An automatic fire suppression system makes it possible to limit the evacuation effort to a smaller part of the building.

### 3.1.1 Safer stairwells

A stairwell in a building is generally free from large amounts of smoke for at least 30 minutes (i.e. 15 minutes after raising the alarm). A stairwell should be free from fire, and from smoke to the extent possible, at least until the end of the fire service intervention time (60 minutes). The smoke freedom value is lower because the doors to stairwells are opened to let people pass through them as part of the evacuation operation and thus smoke may enter the stairwell on the floor where the fire is located. Firefighters who use respirators can continue to use the stairwell for longer than 30 minutes. If the descending speed is one minute per storey, the maximum height allowed for a building can be approximately 50 metres. The descending time determines the permissible building height. If the actual descending time per storey is two minutes (due to the number of people who have to use the escape route or due to people's mobility being affected), the maximum permissible building height is approximately 25 metres. Given current building practices, a descending time of one minute per storey is often a theoretical value, since the dimensions of stairwells in taller buildings are often insufficient to enable this descending time to be achieved if large numbers of people have to evacuate from the building. A funnel effect will occur on lower storeys. Phased evacuation is a possible solution, but this calls for the specific attention of the in-house emergency response organisation. The dimensions of the stairwells of most residential buildings do not lead to any problems. Making it harder for smoke to penetrate into stairwells enables a longer evacuation time so that people can also be evacuated from higher buildings.

However, there are limitations to the maximum evacuation time. At a certain height of the building, it should actually be questioned whether able-bodied people are still physically capable of reaching the street level safely. For the time being this height is set at 70 metres. In buildings of greater heights, a fire will have to be contained or extinguished automatically to avoid a full-scale evacuation.

There are several ways of making it harder for smoke to penetrate into a stairwell, such as:

- fitting all entrances to the stairwell with air locks
- automatically applying overpressure to the stairwell in the event of fire and providing all entrances to the stairwell with air locks
- constructing the stairwell as a safety stairwell.

The stairwell can also be provided with an overpressure system. Besides improving the prevention of smoke penetrating stairwells, there are also possibilities to improve the fire resistance of stairwells. Please note that the different methods applied in order to make it harder for smoke to penetrate a stairwell are not always equally good. For instance, a fire safety stairwell is safer than a stairwell with overpressure. The first solution is more robust and has less risk of failure.

### 3.1.2 Shortening the discovery time

The discovery time in buildings can be shortened by installing a fire alarm system that provides full monitoring. Using such a system enables the discovery time to be shortened, so that there will be more time to put out the fire or evacuate the building. Assuming a one-minute discovery time and two minutes being required to warn the people present, this enables up to approximately 12 minutes to be gained.

### 3.1.3 Automatic suppression

An automatic fire suppression system enables a fire to be extinguished or contained, so that full evacuation in the event of a fire will not be necessary. Automatically suppressing a fire is an aspect that should be considered for buildings with people who cannot leave without assistance. This is strongly correlated with the in-house emergency responders who have to be able to compensate for people's inability to leave without assistance (see section 2.6).

## 3.2 Influencing the intervention time

In principle, the intervention time of the fire service in buildings can be influenced by:

- implementing technical facilities that increase the intervention speed, such as fire service lifts and dry risers (see 3.2.1)
- shortening the discovery and reporting times, leaving more time for the intervention
- deploying an efficient in-house fire service (see 3.2.3)
- automatically suppressing the fire almost immediately after it has started (see 3.2.4).

Note:

The option of shortening the discovery and reporting times does not apply to buildings with automatic fire alarm systems since this is an integral function of such systems, for example for buildings with people who are not able to leave without assistance.

### 3.2.1 Facilities that will increase the intervention speed

The intervention (part of the deployment) is related to the height and size of a building. Assuming that firefighters have to reach the storey where the fire is located while carrying respirators, hoses and other equipment, and while still being physically able to immediately start the follow-up activities, the maximum height allowed for a building without additional fire protection facilities is approximately 20 metres (six storeys). For the time being, it has been assumed that this height is also the maximum height that firefighters can cover on foot such that they will still be physically capable of getting people to safety and extinguishing the fire. At greater heights, effective fire service lifts and dry risers will have to be applied. To enable the most effective and safest intervention by the fire service, any stairwells that are used as routes of attack must be provided with air locks. Fire extinguishing units can supply water of sufficient pressure up to a level of approximately 70 metres high. Risers and a pump system have to be provided if the building is higher than 70 metres. Due to the necessity of rapid deployment, a similar situation may occur in the horizontal plane in complicated buildings. In that case, a dry riser in the horizontal plane can be the right solution. This may require specific bespoke solutions in buildings with long and/or complex routes of attack. Such bespoke solutions may require the provision of:

- dry or wet riser systems (high/low pressure)
- fire hydrants in connection with entrances and locations where the fire service can set up its equipment.

### 3.2.2 Shortening the discovery and reporting times

The intervention time can be extended by shortening the discovery and reporting times. The discovery and reporting times can be shortened by using a fire alarm system that provides full monitoring. Applying such a system enables the discovery time to be reduced and time to be gained. Assuming a 1-minute discovery and warning time, some 14 minutes can be gained. This has been provided for non-residential buildings in groups 2 and 3. A fire alarm system with full monitoring is a basic facility in such buildings, serving to protect the people in these buildings against the effects of fire and smoke.

### 3.2.3 Deploying an efficient in-house fire service

Deploying an in-house fire service shortens the mobilization time. The in-house fire service is already present in or near the building. In-house fire services can be found in industrial companies, specifically where hazardous materials are produced, processed and/or stored. In theory, this option may also be applied to other types of buildings. An in-house emergency response organisation is not the same thing as an in-house fire service (see section 4 of chapter 6).

### 3.2.4 Reducing the deployment of the fire service

Automatically suppressing the fire almost immediately after it has started enables the deployment of the fire service to be reduced.

Finally, it should be noted that having some idea of the intervention by the fire service is important from the point of view of prevention as this provides an understanding of the scope of the repressive actions of the fire service. This understanding enables optimum protection options in a building (see section 2.3.1. of chapter 6). A pre-condition for this is that choosing other fire safety measures and facilities must not conflict with statutory schemes.

## 4. In-house emergency responders, risk assessment and evaluation

The in-house emergency responders contribute to controlling any safety risks. The policy as regards the in-house emergency response service and its organisation results from the risk assessment and evaluation. The risk assessment and evaluation forms the basis for preventing and fighting risks in a building. A risk assessment and evaluation must be made, according to a pre-defined method, of all risks present, i.e. also the risks due to an in-house emergency response being implemented. The risk assessment and evaluation serves as the basis to assess which measures must be taken in order to control the risks. However, some risks cannot be avoided. Due to such 'residual risks', repressive action may be necessary after an accident or incident in order to reduce and control these risks. Fire risks and risks of accidents that lead to injury are covered by the scope of a risk assessment and evaluation. In order to control the consequences of a fire or of an accident that leads to injury, an in-house emergency response plan must be drawn up, taking the following normative factors into account:

- The size and location of the building (including risks posed by its surroundings). The size of the building is one of the factors that is considered to determine how the in-house emergency response organisation should be set up. This concerns the number of people (staff and others) as well as their usual locations in the building.
- The fire and accident scenarios that are deemed to be normative, i.e. set the standard, for the building.
- The number of staff and other people that can reasonably be expected to be present, as well as the times when they are, or tend to be, present. Knowing when employees who can be used for emergency response tasks are present and how many of them are present is important.
- The number of people that can reasonably be expected not to be able to get themselves to safety in the event of an accident or a fire.
- The possibilities offered by the fire service and other emergency services. The in-house emergency responders act as a 'first response unit' for the government's emergency services such as the fire and ambulance services.
- The opportunity of working together with other organisations (evacuation plans, information about risks, preparing for accident and disaster scenarios, joint drills and actual joint operations). If the building

houses several employers, they should have a joint in-house emergency response operation that is considered as one in-house emergency response organisation for all the employers present.

- The demonstrable expertise that is present.

The in-house emergency response plan must address such aspects as objectives, tasks, procedures, resources and means, including instructing and training the in-house emergency responders. This requires that the details of the 'emergency response job' that must be done are clear. The use of scenarios enables a better understanding of this 'job' which can serve to further detail the activities to be performed by the in-house emergency responders. The current and accepted risk assessment and evaluation methods are often insufficient for this. An additional fire risk assessment and evaluation, i.e. a specific fire safety analysis, may fill this need.

#### 4.1 Additional fire risk assessment and evaluation

Just like a regular risk assessment and evaluation, the objective of an additional risk assessment and evaluation is to identify and control any risks. An additional risk assessment and evaluation is more detailed. An additional risk assessment and evaluation may be part of a regular risk assessment and evaluation. The purpose of an additional risk assessment and evaluation is to optimally match a building and the in-house emergency response organisation to each other. The implementation of an additional risk assessment and evaluation focuses on the hazard aspects in the event of a fire and on reducing and fighting them. Scenarios are good instruments for achieving this. Working with scenarios helps people to think more in terms of safety. The additional risk assessment and evaluation serves to provide an understanding of the fire protection in the building (architectural, technical systems) in combination with the intervention by the in-house emergency responders and the intervention by the fire service. This understanding enables responsible choices to be made for individual buildings, regardless of whether they are new or existing buildings.

The current statutory provisions provide a good basis for arranging effective fire safety, provided that the in-house emergency responders intervene effectively. The next question then is whether the in-house emergency response organisation has sufficient skills and capacity. The in-house emergency responders provide first-line emergency response and are faced by some limitations in this respect. It would be incorrect to assume that in-house emergency responders can solve everything. The actions by in-house emergency responders are partly based on the architectural state of the building and the technical systems in the building. The risk assessment is a crucial element of the evacuation/fire suppression tasks performed by the in-house emergency responders. This is specifically important in high-risk, complex buildings, e.g. buildings where people are present who are not able to reach safety without the help of others. In such situations, the in-house emergency responders' tasks should primarily focus on compensating for such people's inability to leave without assistance. While assessing the risks, it will often be necessary to weigh one's own safety, which is of prime priority, against the need to evacuate people; this decision will have to be



taken under high pressure.

In buildings where there are people who cannot leave without assistance, an in-house emergency responder has to take a decision that is related directly to people's chances of falling victim to the fire or not. This is definitely not an easy choice and it will affect the mental well-being of the people in question. Fire protection as a combination of the common physical fire safety facilities and organisational measures, including the in-house emergency response organisation, is a complex task and its integrity and quality may be affected by many factors. Human actions are the central element in this. Crucial decisions, that always have subjective elements, play a role. The circumstances that exist in the event of a fire, will definitely not improve fallibility. The costs should also be considered, since an in-house emergency response organisation must be maintained for the entire time that a building is occupied. Costs can be influenced by using technical facilities.

Note:

It is important that in-house emergency responders have information that enables them to carry out interventions safely. Deployment in the event of a fire requires in-house emergency responders to assess the risks by weighing their own safety - which has the highest priority - against their emergency response tasks. Visible and tactile sources of information may help the emergency responders take the right decision. Closing the doors to the room that is on fire is an important element. Specific attention must be paid to the correlation between extinguishing and evacuation: what is done first and in which circumstances?

The majority of fire safety experts agree that influencing the source of the risk is an excellent fire protection method. This method may help ensure that a fire is contained as a minor fire or is extinguished. The underlying philosophy is that minor fires cause less danger than major fires. A sprinkler system may help ensure this. The system positively contributes to achieving better conditions for such aspects as timely intervention and limiting the temperature and smoke development, and, consequently, to the safety of the in-house or external emergency responders and to the people who are not able to reach safety without the help of others. Automatically suppressing fires will positively influence the fire scenarios. In that event, a fire of a pre-defined and limited scope can be taken into account, as a result of which this part of fire protection will become considerably less vulnerable compared to a situation where this is not the case. Automatic suppression contributes to early intervention in the events that play a role in a fire and helps reduce the effects of a fire.

Using a sprinkler system brings substantial safety benefits since:

- the vulnerability of the fire safety is greatly reduced, compared to a building without a sprinkler system
- the chances of people being rescued are increased, resulting in fewer casualties
- only limited evacuation is required
- the in-house emergency responders run fewer risks
- the building can be used more flexibly without negatively affecting fire safety.

## 4.2 Phased plan for additional risk assessment and evaluation for fires

An in-house emergency response organisation acts in the context of the architectural and technical fire safety facilities in a building. This means that an understanding of the building's state of fire safety is important, as this may have consequences for the set-up of an in-house emergency response organisation. The understanding obtained can be used to consider the protection options in order to match the building and the organisation to each other as closely as possible.

An additional risk assessment and evaluation consists of three steps:

Step A: Assessing the building's state of fire safety

Step B: Mapping the intervention by the fire service

Step C: Analysing the building in connection with an intervention by the fire service (the correlation between A and B).

See figure 52 for a diagram of the additional risk assessment and evaluation.

### *Step A: Assessing the building's state of fire safety*

Step A is assessing the structural and systems-technical state of the building to clarify whether the building is adequately protected. The existing building regulations can be used as a reference for the level of the standard, but a similar standard obtained on the basis of equivalent fire safety can also be applied. The assessment will yield one of two possible results: the building complies with the standard set in the building regulations or it does not comply with the standard.

#### *A-1 The building complies with the standard*

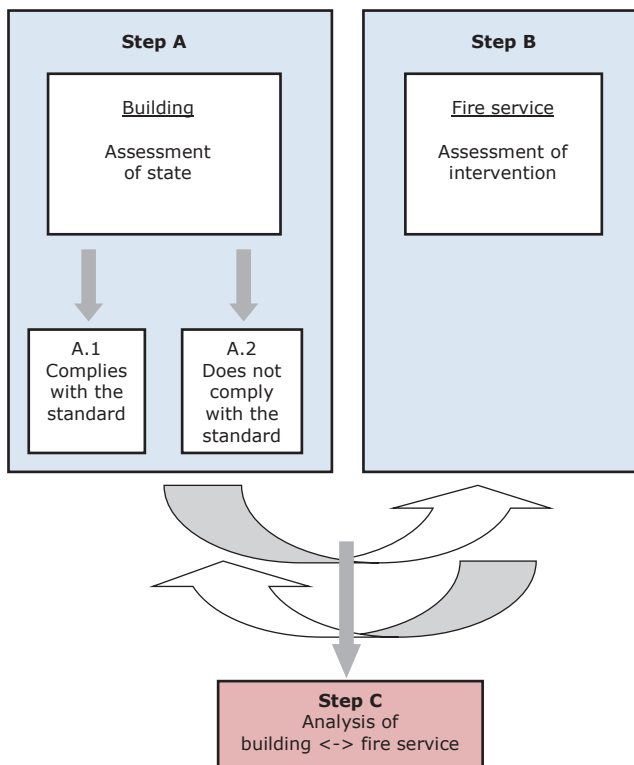
If a building complies with the standard, the in-house emergency response organisation can be set up. Normative fire scenarios for the assistance provided by the in-house emergency responders play a role in this. When setting up the in-house emergency response organisation, the physical possibilities of the in-house emergency responders and the correlation with their regular tasks must also be taken into account. If they are insufficient, alternative protection options will have to be assessed.

#### *A-2 The building does not comply with the standard*

If the building does not comply with the standard, there are shortcomings as regards fire safety. The question then is if this has any consequences for the setting up of the in-house emergency response organisation. To be able to assess this, the shortcomings must be analysed in combination with the physical possibilities of the in-house emergency response organisation. Using normative fire scenarios for the emergency response in the analysis enables a better understanding to be obtained. Decisions can then be taken, depending on the shortcomings and the results of the analysis. The options are:

- accepting some or all of the risks and/or
- implementing fire safety facilities and/or
- taking additional organisational measures in the context of the in-house emergency response organisation.

As regards the latter point, it should be noted that the risks run by the in-house emergency responders must not be greater than they would be if the building did comply with the standard.



**Figure 52** Diagram of additional risk assessment and evaluation

**Step B: Mapping the intervention by the fire service**

The basic assumption is that buildings should be sufficiently safe, given the internal organisation, and that taking the success of repressive action as a means of prevention for granted in advance will lead to an uncertain safety situation. There is a relationship between the in-house emergency response organisation and intervention by the fire service. The underlying coordination between both organisations, particularly in complex, high-risk buildings, is important. And it is also important that the various parties know what they can expect from each other. Knowledge of the locally available intervention time is part of this. Late intervention may have its consequences.

**Step C: Analysing the building in connection with an intervention by the fire service**

In order to be able to consider alternative fire protection options, it is important that, as part of the analysis, the consequences of late intervention are related to the fire protection measures and facilities that have been or are intended to be implemented in a building. Late intervention by the fire service, specifically the aspect of the response time, does not automatically imply an unsafe situation. To obtain an understanding of the possible consequences, the actual total response time in combination with the fire protection (architectural, technical systems and organisational) in the building must be analysed and weighed. In all situations, occupants

of a building are, in first instance, on their own as regards evacuation and putting out the fire. When considered from this perspective, there is effective fire preventative care in a building if the in-house emergency responders act properly (especially in order to evacuate people) and a fire stays within the partitioning structures of the fire compartments or sub-compartments for the required fire resistance time in minutes.



## **Chapter 5**

### **Risks in the event of a fire**





## Introduction

‘Risk’ is a certain way of designating danger. The term gives an impression of the probability of an undesired event occurring, associated with the consequences of the event. Risk can be typified as a method to deal with uncertainty. Risks are an inseparable element of our contemporary society. People are exposed to them all the time, willingly or otherwise. People are often unaware of which risks they are running. However, based on their own personal decisions, people can choose which risks they are willing to take. Examples are the risks of smoking, extreme sports (e.g. mountaineering) and accepting insufficient fire safety (e.g. if there are not enough escape routes) when buying a house. Knowledge of the risk factors is a precondition for making the right choices. People are often also faced with involuntary risks, which means that making one's own choices is more difficult, if not impossible. Examples of involuntary risks are the risks of fire safety in the event of an urgent admission into hospital (how fire-safe is the hospital?) and the risks run by people who live in an area where transport routes for hazardous materials have been planned.

Section 1 focuses on themes such as fire risk, risk perception and the acceptance of risks. Section 2 deals with controlling fire risks using the ‘bow tie’ model. This is done in connection with developments in the fire service that have been made in the context of the vision for the future of the Dutch fire service, as outlined in the ‘*Brandweer over morgen*’ (Fire Service for Tomorrow) scheme. Section 3 is about risk control methods. Here, key terms such as deterministic, probabilistic, quantitative and qualitative are explained. Section 4 provides a further explanation of people's behaviours and the concept of people's inability to leave without assistance. Fire risks in buildings are addressed in section 5. The fire risks are studied on the basis of a classification of the building, the circumstances of people's presence in the building, the occupancy aspects and the human factor. Section 6 presents a theoretical explanation that enables fire risks to be translated into fire protection options. The instruments for this are fire scenarios, the probability-impact matrix and the event tree. Section 7 links risk factors to types of buildings and presents a model of a risk indication system for buildings. Finally, section 8 provides information about the causes of fires in buildings and the resulting consequences.



## 1. What is fire risk?

Fire can pose a danger and, as a result, involve risks. The parties involved in designing and assessing fire safety, such as designers, advisers and assessors, first form an impression of a fire situation. A fire may occur, but it is never certain that this will actually happen. We perceive this as a fire risk. The concept of 'fire risk' consists of two elements: an assessment of the risk of a fire occurring and a negative impact. Both elements can be classified from small to large. The impact can be the consequences of fire in the broad sense, such as the immaterial, material and administrative consequences.

$$\text{RISK} = \text{PROBABILITY} \times \text{IMPACT}$$

Both the extent of the probability and the extent of the impact can vary. Here, a matrix of four categories can be drawn up as a schematic classification of fire risks.

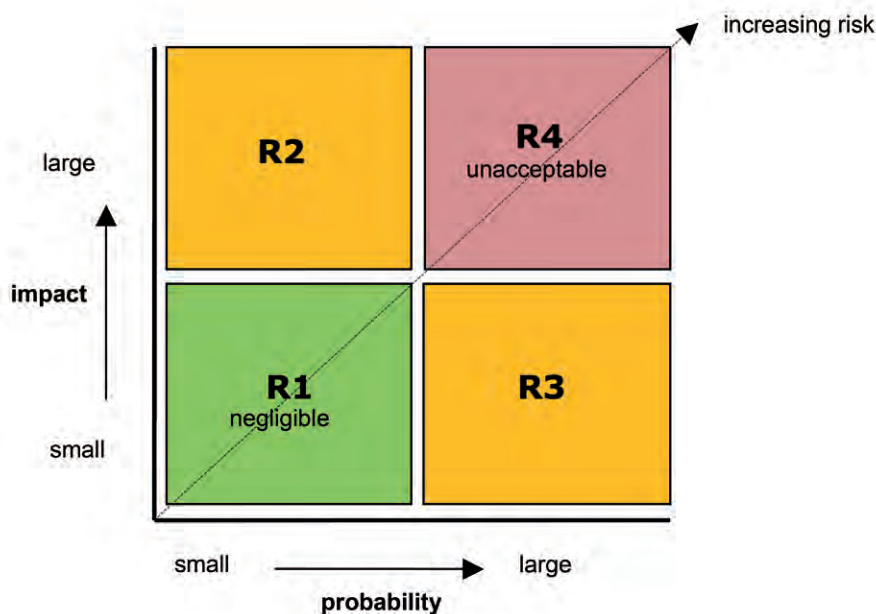


Figure 53 Schematic view of risk categories in a risk matrix

Category R1: low probability and low impact; we do not worry about this. We perceive this as an acceptable risk.

Category R2: low probability with a high impact. We are very much aware of this, but if the advantages outweigh the disadvantages, we are often willing to take this risk.

Category R3: high probability and a low impact. We, once again, weigh these against each other. We classify a low impact as an inconvenience that we would rather not experience too often.

Category R4: high probability and a high impact. We perceive this to be an unacceptable risk.

The quadrants R2 and R3 represent situations where we have to weigh the probability against the negative impact of fire and the likely advantage. These quadrants form the transition area between unacceptable risks (R4) and negligible risks (R1). People are inclined to accept higher risks if certain advantages can be obtained by doing so, for example in situations where not implementing any fire protection measures and/or facilities would have advantages for an organisation's business operations, as might be the case if a fire-resistant partitioning structure were not installed. Sabotaging fire protection measures and/or facilities may play a role, such as using wedges to block fire-resistant and self-closing doors in their open positions and deactivating an automatic fire alarm system. For situations that fall in quadrants R2 and R3, an attempt is made to reduce the risk by implementing fire protection measures and/or facilities. This risk is always greater than that of the negligible risks in the R1 quadrant.

In the real world, there is not a distinct dividing line between the four risk quadrants; they merge into each other. The point of zero risk can be found in the lower left-hand corner of figure 53: the probability is zero and there is no negative impact. The situation of maximum probability and a maximum impact can be found in the top right-hand corner. Probability and impact increase along the imaginary diagonal line from bottom left to top right, with the risk increasing from minimum to maximum. Zero risk can only be achieved for individual aspects of fire safety. However, fire safety consists of a lot of aspects, all of which involve a certain risk. This can never be avoided. This means that a certain degree of risk, or a certain degree of danger, will have to be accepted.

### 1.1 Risk perception

Risks can be large or major, small or minor, acceptable or unacceptable. The question is when a risk is a major and unacceptable risk. The answer is related to how risks are perceived and this can differ from one person to another. What is perceived as an acceptable risk by one person might be a major risk to someone else. People usually evaluate a risk on the basis of the extent of the impact. The more casualties there might be at the same time, the higher the risk is considered to be. Past experiences with fires may cause some people to assess a certain situation as a major risk, where others might perceive it as a minor risk, or the other way around. Furthermore, the more people think they are in control of a situation, the lower they will perceive the risk.

### 1.2 Acceptance of risks

Risk perception and acceptance of risks are strongly interrelated. How people see a risk is a decisive factor in whether they are willing to take the risk or not. People are prepared to accept greater risks if they think they have full control of the potential danger. The opportunity to obtain advantages also plays a role in whether a risk is accepted or not. The greater the advantage will be, the more prepared people will be to take the risk. An example of this is locking the emergency exits in a shop to prevent people from leaving without paying. A shopkeeper who does this acts in violation of the regulations and can be penalised. If the shopkeeper does



#### Risks of underground buildings

not perceive this as a serious risk or a serious impact, or thinks ‘the risk of getting caught is so slight that I’m willing to take it’, they may decide to lock the emergency exits. The shopkeeper then makes an individual choice that involves negative consequences if a fire breaks out. This example shows that acceptance of risks, here by the shopkeeper, is related to the choice of whether or not to take a risk. When an individual person makes such a choice, the consideration as to whether to accept a risk or not may be quite hard, especially if several parties are involved who all have their own different risk perceptions. Making choices is then harder still.

## 2. Controlling fire risks: the 'bow tie' model

Many developments are currently taking place within the Dutch fire service in the context of the 'Brandweer over morgen' (Fire Service for Tomorrow) programme that has been initiated by *Brandweer Nederland* (the organisation of Dutch Fire Services). Regenerating the Dutch fire service is the key issue here. The scheme emphasises fire prevention in combination with revamping repressive action. Controlling fire risks is also part of this scheme. We have tried to align this document with this scheme. In the context of controlling fire risks, this alignment has been achieved by using the bow tie model. Fire has been chosen as the key event, see figure 54. The bow tie model should be read from left to right. The fire, i.e. the key event, is placed in the middle. The fire causes can be found on the left and the consequences on the right. Fire causes can be portrayed by means of an error analysis. The effects, or 'impacts', are shown by means of an events analysis. Intervention points, to influence the fire's development as a cause and effect chain, exist on both sides, ranging from actions to prevent a fire on the one hand and actions to ensure that, if a fire does break out, it is brought to the safest conclusion possible, on the other. This subdivision is a rather crude classification. A more detailed analysis of the fire chain shows the concrete measures and facilities, and the lines of defence or 'barriers' in the chain. The vertical arrows in this figure that cross the horizontal branches of the error and event tree are the 'lines of defence'. The arrows in the figure show that an effective line of defence leads to a safe(r) conclusion of the fire, such that a controlled and untroubled situation can eventually be resumed.

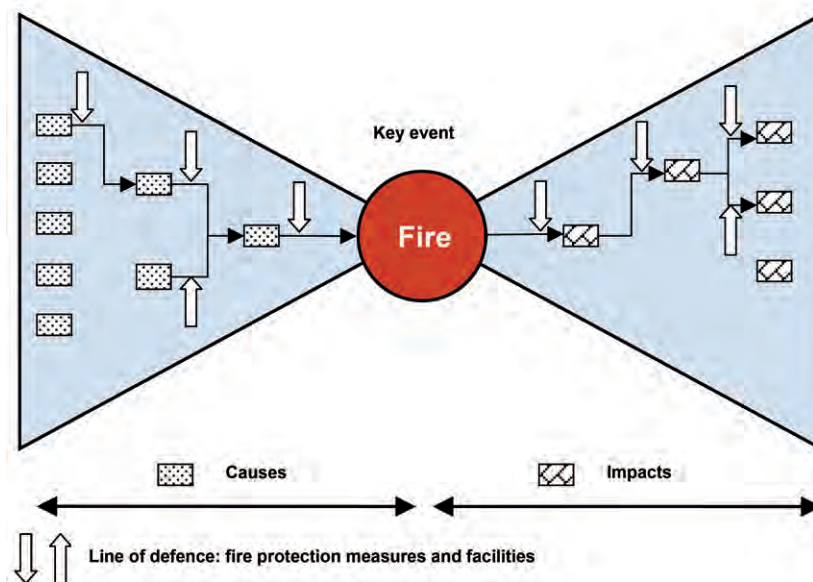


Figure 54 Bow tie model

The bow tie model presents the framework for reducing risks. The following basic principles apply here: place the lines of defence as early as possible in the fire chain and think of measures and facilities that serve to prevent fire in the first place, such as preventing sources of ignition due to work, using sound electrical systems and devices and using fire-safe items of furnishing. Do not forget that any lines of defence that are located later in the chain

have consequences for the occurrence of a fire and, once a fire has started, for the consequences of a fire. If not all the risks can be prevented, the lines of defence must aim to prevent and reduce the risks and their consequences as much as possible.

A risk assessment can be made of fire risks; these risks can then be analysed and translated into fire protection measures and facilities. This can be done by using fire scenarios. These are descriptions of how a fire may occur, with the relevant causes, and the possible development: the consequence. In other words: this is a cause and effect relationship.

The lion's share of risks may be reduced by lowering the probability or limiting the impact, but there will always be some risks that cannot be reduced or only by disproportionate efforts. These residual risks will have to be explicitly accepted.

Figure 55 provides a summary of issues that may help prevent fire, i.e. probability reduction, and reduce the effects, i.e. impact reduction.

↑ Probability reduction	↑ Impact reduction
Improve users' safety awareness	Use small extinguishers
Improve the safety of products and systems	Use an automatic fire suppression system
Optimise maintenance of fire protection measures and facilities	Use an automatic fire alarm system combined with rapid intervention
Use non-combustible materials	Set-up an effective in-house emergency response team
Instruct / educate users	Have an operational evacuation plan and do evacuation drills

**Figure 55** Summary of probability reduction and impact reduction

### 3. Risk control methods

A deterministic or a probabilistic approach can be taken to fire risk control methods.

#### 3.1 Deterministic approach

The deterministic approach is based on a distinct dividing line between good, i.e. safe, and bad, i.e. unsafe. Safe is when the rules are followed. The deterministic approach does not consider the extent of the fire risk or the probability of a fire. The Dutch Building Decree is largely a deterministic document. This can mainly be seen by the fact that threshold values are given for performance requirements. These requirements primarily aim to limit and contain a fire that has started. The majority of these requirements do not aim to prevent fire.

#### 3.2 Probabilistic approach

The probabilistic approach is all about the extent of the risk. This is calculated by obtaining an understanding of both the probability and the consequence. The difference between a deterministic and a probabilistic approach is explained in the example below.

### Example

On the basis of the Dutch Building Decree, a certain situation requires that a fire partition in a building has a fire resistance of at least 60 minutes and the door structures in that partition have at the least the same fire resistance value and are self-closing. Please see the determination methods laid down in standards for further specifications.

If the fire partition is constructed in accordance with the specifications and is then maintained properly, it can be assumed to make its expected contribution to fire safety. In a deterministic approach, things are good or bad or right or wrong and nuances do not play a role at all, or only an insignificant one. The functioning of the fire partition in an actual fire situation is not taken into account. A probabilistic approach does take the real-world situation into account by providing an understanding of the risks (here the probability of failure of a fire partition and its consequences). The '*Miljoenenbranden in Nederland*' (Million euro fires in the Netherlands) report from 2003 illustrates this. In the context of an assignment, the Dutch Association of Insurers asked the former Nibra organisation to study fires that resulted in damages of more than one million euros, and that occurred in 2001. The study looked at aspects such as the functionality of the fire preventative facilities, including fire compartmentation. The study identified 32 cases where fire compartmentation played a role. In 15 cases, fire compartmentation did not work properly. The reasons why fire compartmentation failed were listed as their not being sufficiently fire resistant or being used incorrectly, for example by fire doors or other doors being opened, negating the effectiveness of the fire compartment. It was also found that some 50% of the self-closing doors in the buildings studied failed to close. Without drawing far-reaching conclusions from the study, it can be assumed that a probabilistic approach to fire safety enables the probability of failure of fire protection measures and/or facilities, in this case a fire partition failing, to be taken into account, and the study shows that the probability of failure of a fire partition is quite real.

### 3.3 Quantitative or qualitative

The extent of a risk can be determined quantitatively, semi-quantitatively and qualitatively.

A characteristic of a quantitative method is the unambiguity of threshold values for the acceptance of risks. An example of such a method is the statutory regulation for external safety, based on the Dutch Major Accidents (Risks) Decree (*Besluit risico's zware ongevallen – BRZO*). This decree provides statutorily permissible threshold values for the risk that people may run as a result of hazardous materials. The decree contains instructions for scenarios and calculation methods.

As regards the fire safety of buildings, the Netherlands does not have statutory regulations for the acceptance of risks and no such regulation is expected to be adopted in the near future either. Information about fires is required to enable threshold values for acceptance of risks to be developed. Analysis of such information serves as the basis for enabling the threshold value for a statutorily permissible fire risk to be developed. This can be provided by information from case histories, statistics and fire studies or fire research. However, the problem is that too little information about this is available and what there is tends not to be sufficiently in depth. Actually, more data is available for residential than for non-residential buildings.

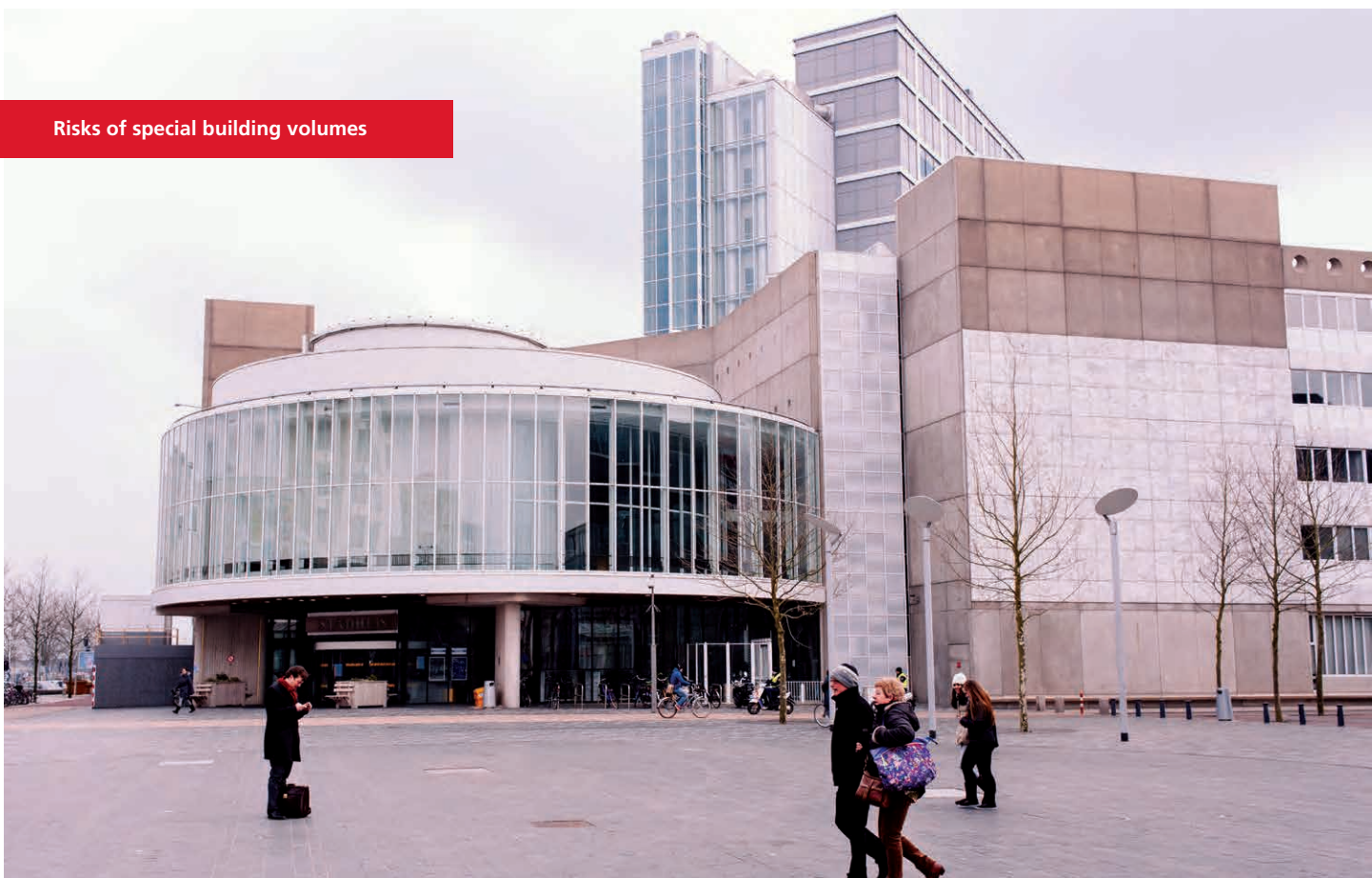
The consequence of this restriction is that developing a quantitative risk method that might serve as a standard is not really possible at the moment. However, a qualitative or a semi-quantitative method would be a possibility. Information from case histories, statistics and fire studies can be used for this. If such information is insufficient, an expert could be asked to give their final judgement. Although a qualitative or semi-quantitative method is more general, it can yield valuable results if applied with sufficient expertise. This method is actually used in current practice. It can be integrated with the bow tie model. This model comprises scenarios and events (cause and effect relationships) to which probability can be assigned. This method is the framework for the risk approach to the fire safety of buildings.

Note:

The process industry and the work safety sector use quantitative methods. If, as regards causes, no probability is known from case histories and statistics, a fault tree is used in order to calculate the probability of the key event occurring. An event tree is used for the consequences. An event can be influenced by protection measures and facilities. Their proper operation can be assigned a probability value which can then be used to determine the probability of the eventual consequences. Actually, assigning the probability of failure results in uncertainties.

Developments in the context of the Dutch Fire Safety Action Programme (*Actieprogramma Brandveiligheid*) are referred to as a possibility for drawing up a quantitative risk analysis method for the fire safety of buildings in the future. This programme was drawn up by the Dutch national government (the former Ministry of Housing, Spatial Planning and the Environment and the former Ministry of the Interior) and it was instigated as a result of the

### Risks of special building volumes



fire at the Schiphol cell complex. This programme contains an exploratory study into the risk-based fire safety assessment.

Annex 1 of the action programme states the following:

“Risk model for fire safety in health care/feasibility study. To give the risk approach more concrete detail, the Ministry of Housing, Spatial Planning and the Environment commissioned the RPS consultancy firm to develop a risk model for fire safety. The purpose of this model is to provide an understanding of the risks and control measures in the event of fire. The model can be used to quantify these risks in principle, and it enables the effectiveness of control measures to be determined. The eventual goal is to make a contribution to the discussion about the use and feasibility of such a risk model for fire safety policy in the Netherlands. A feasibility study aimed at buildings in health care was opted for in this project. Risk models that enable both the risks of different types of work accidents and the effectiveness of control measures to be quantified have been drawn up in the context of the programme to improve work safety and its work safety risk model (*Versterking Arbeidsveiligheid – RAM (Risicomodel Arbeidsveiligheid)*) of the Ministry of Social Affairs and Employment. The same methods, based on the bow tie model, were used in this project. Input from experts (especially from the Dutch fire service and the Netherlands Institute for Safety) and data from analyses of historic fires were used to develop the model. At present, only very few of these types of analyses are available. As a result, there is no collective memory that can be consulted in order to structurally map experience gained from studies into the causes of fires. The model that was developed offers a structure for analysing direct and indirect causes of fires and can serve as an instrument to analyse trends.

The philosophy underlying the use of the risk model is that the risk can be reduced in a targeted manner and cost-effectively by taking measures aimed at factors that have the greater share in the risks. This makes this model useful for companies and organisations that would like to improve their fire safety situation. After some further developments, the model can now be used for quantitative calculations of fire risks enabling calculations to be made of strategies of measures. This enables alternatives for building structures, safety facilities and organisational measures to be compared to each other on the basis of their risk levels. This approach is initially suitable for complex, high-risk objects where this model can be used to apply specific standard or bespoke control measures based on performance requirements.”

No efforts have yet been put into further developing the model.





Risks of large non-compartmented surfaces

#### 4. People both posing and carrying the risk

People are the crucial factor when considering the interrelationship between buildings and fire safety. People both cause risks and run risks. As risk causers, they play a role in a fire being started, e.g. in the event of arson or not observing due care when handling fire. Insufficient maintenance of systems and equipment may also contribute to the risk of a fire occurring.

The people who are present in a building are the people who run the risks, i.e. the 'people at risk', as they undergo the fire risks. The risk that a fire hazard poses for people largely depends on their personal situation, i.e. the circumstances of their presence in the building. A crucial element is the distinction between people who are able to reach safety on their own, i.e. able to leave without assistance, and people who rely on others for their safety as would be the case in a hospital or a prison. Patients in hospital are 'not able to leave without assistance' and the inmates in a prison are 'prevented from being able to leave without assistance'. To flee, both the patients and the inmates depend on others to help them, i.e. they are not able to leave without assistance.

Note:

In response to the fire in the K-wing of the Schiphol cell complex, the Dutch government drew up the Fire Safety Action Programme. The final report of this programme was presented to the Speaker of the Dutch House of Representatives in April 2009. This programme focuses on buildings with residents and occupants who are vulnerable or who depend on others for their safety, i.e. people who are unable or partly unable to leave without assistance.

People's inability to leave without assistance is contrasted with people's ability to leave without assistance. People's behaviour is an important factor here. During the initial phase of a fire, the people present in a building mainly have to rely on themselves and on the people in their direct vicinity. People's behaviour during this first phase is the most crucial. Their reaction to the first signs of fire especially influences their chance of surviving the fire. And besides this, the availability of fire protection facilities, such as escape routes and emergency exits plays a decisive role. It takes a while for internal and external emergency assistance to be initiated. The chance of surviving a fire is determined by people's reaction to fire and their ability to leave without assistance.

The ability to leave without assistance in the event of a fire is the human capacity of observing and interpreting danger signals, and of making and implementing decisions aimed at surviving a fire situation. (*M. Kobes*)

#### 4.1 Not being able to leave without assistance in the event of a fire

'Not being able to leave without assistance in the event of a fire' is used to describe situations where people's capacity is insufficient to enable them to independently take decisions and/or action in order to survive fire situations. This implies that people depend on others to save them. In present-day practice, the concept of a 'reduced ability to leave without assistance in the event of a fire' is also used as an intermediate form to express the insufficiency of people's capacity, and this applies to such buildings as those where the residential and care functions are combined with each other. There is no straightforward definition of this term. Reduced ability to leave without assistance is related to the insufficiency of a person's capacities. Where necessary, this relationship should be expressed in the protection options (the fire protection measures and/or facilities), e.g. by providing an effective internal assistance organisation that can give collective instructions to help people evacuate the building safely. The people at risk will then have to be sufficiently mobile and their mental capacities should also be sufficient. People who are not able to leave without assistance require individual help.

### Example

The fire that broke out in the Rivierduinen institute for mental healthcare in Oegstgeest, the Netherlands, on 12 March 2011, killed three patients. The Dutch Safety Board studied this fire and reported on it in April 2012 in the report entitled '*Brand in Rivierduinen: veronderstelde veiligheid*' (Fire in Rivierduinen: alleged safety). The review of the study stated and concluded that healthcare institutions are considered as high-risk organisations, that there is a high probability of fire and that the evacuation of patients or residents is often frustrated by their physical and/or mental condition. The institutions are responsible for patients or residents whose physical or mental conditions affect their ability to leave without assistance. This makes them dependent on others for their evacuation. Dealing critically with these factors is crucial for fire safety in healthcare institutions. The conclusions suggest that an integral approach should be the norm for fire safety, taking into account the extent to which the people at risk are able to leave without assistance.

## 4.2 People's ability to leave without assistance and their behaviour

How people behave influences the extent to which they will be able to leave without assistance in the event of a fire and, as a result, this influences the evacuation process. The Netherlands Institute for Safety (NIFV) performed an extensive literature review into fleeing from a fire. More than 150 international publications were studied for this. The study was documented in a publication entitled '*Zelfredzaamheid bij brand: kritische factoren voor het veilig vluchten uit gebouwen*' (Being able to leave without assistance in the event of a fire: critical factors for fleeing safely from buildings). The document provides a summary of current knowledge of the factors that determine people's ability to leave without assistance in the event of a fire. It contains a comparison between scientific data and the basic assumptions of fire safety policy.

### Survival strategies

In the event of a fire, human behaviour plays a role in relation to people becoming aware of a fire, taking decisions and the actions that should be taken. Three possible strategies can be applied in order to survive a fire. The first strategy is fighting the fire. Taking effective action creates the possibility of putting out the fire or limiting its extent. Studies conducted in Great Britain and Australia have shown that 75% of all fires in the home are put out by the residents themselves. Little is known about how fires are extinguished in other types of buildings.

The second strategy is seeking shelter and waiting to be saved by others. However, various fires showed that people tend to prefer to walk through smoke or jump from buildings instead of waiting for others to save them. It is not clear why people jump from buildings in the event of a fire. It may be a deliberate choice where people prefer to jump and die by their own choice rather than dying due to suffocation or falling victim to the flames. The answer to the question of why people walk through smoke although they

know that this is dangerous, or choose a survival strategy instead of finding a safe place where they wait for others to save them, is not known yet. The third strategy is fleeing. The aspects of fleeing from a fire have been studied the most and have been given the most attention in the relevant literature.

### **Process of fleeing**

The process of fleeing consists of three basic activities that are carried out in sequence:

- becoming aware of danger due to external stimuli
- validating such danger signals and reacting to them (decision-taking)
- moving to a safe location.

Signals and indications play an important role in *becoming aware* of a danger. There are strong indications that, in general, people have little awareness of danger. The presence and density of smoke are direct signs of danger, but people seem to find it hard to properly assess danger signals. Furthermore, several evaluations have shown that, if unexpected events occur, people initially hold on to the role expectations that match the purpose of the building they are in and they ignore the signals and signs of danger.

The *decision-taking process* of people in the period before and while fleeing is determined by their personal reaction to the behaviour of others in their direct surroundings (social factors) and to the ambient conditions (heat and smoke) due to a fire and the building's design.

*Moving to a safe location* depends on the interaction between:

- The building's design. Among other things, this influences which route people will take.
- The ambient conditions (heat and smoke) resulting from a fire in combination with human behaviour while fleeing (human characteristics).

Besides this, organisational aspects may influence the evacuation or fleeing process, such as the availability of an evacuation plan and experience of evacuation drills. The behavioural aspects for fleeing depend on personal circumstances. Examples of behavioural aspects are age, fitness and alertness. The behavioural aspects also play a role in relation to the building, e.g. if the building has a complex layout and/or a high occupancy.

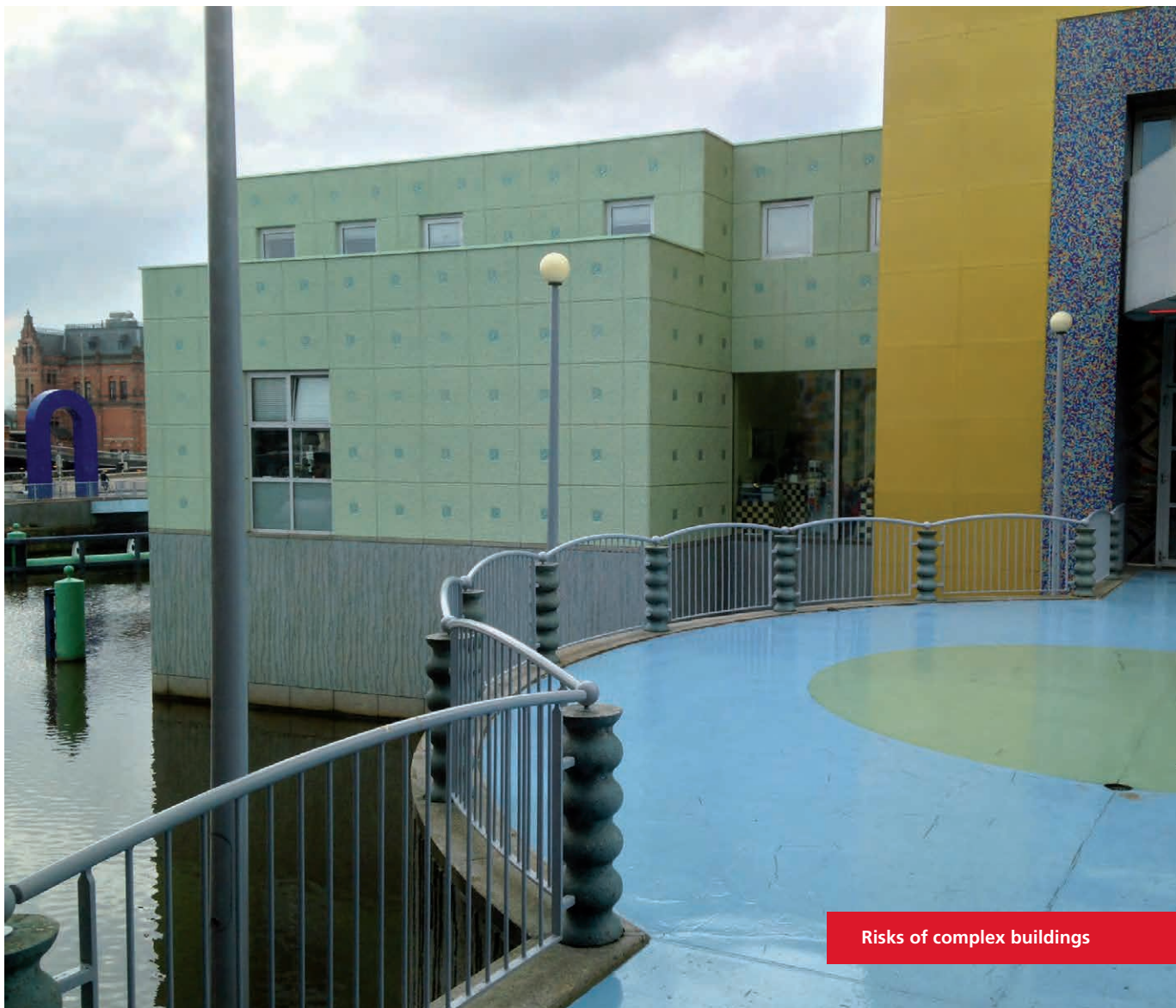
### **Human characteristics**

The personal characteristics of stress level, mobility, physical fitness and powers of perception influence behaviour in the event of fire and particularly the evacuation time. Incident evaluations have shown that many people 'of average mobility' have problems descending stairs.

Other personal characteristics whose influence is not entirely clear are: gender, age, follower/leader, knowledge and experience, faith in one's own abilities and profession. People's faith in their own abilities affects the choices they make, the effort they take to do something, how long they persevere with an action if they are confronted with obstacles (and fail) and how people feel. Although this theory has not been tested in emergency situations, faith in one's own abilities may also influence the decisions people take in emergency situations. The parallel with escaping from an emergency is evident.

Person-related situational characteristics that influence people's ability to leave without assistance mainly concern their alertness, their perception of danger, their physical position and their familiarity with the building. The main indicator for alertness is whether people are sleeping or are awake. People who are sleeping have a very low level of alertness for what is happening in their direct surroundings. Furthermore, people tend to take the route they are familiar with.

The main social characteristics in relation to fleeing are group behaviour and social ties, task commitment, the roles and responsibilities of the people present, safety training and in-house emergency responders. In general,



people behave unselfishly while fleeing from a building. People also usually look first at others' actions and then react in the way that the people in their direct environment react. In situations that they are not familiar with, people will often rely on the staff that work in the building, as they are expected to be familiar with the building. Incident evaluations have shown that people follow the instructions of people of authority if these instructions match their own assessment of the situation. Furthermore, there are some examples of fires where people were within visual range of the seat of the fire and still continued with their activities.

Several experiments and incident evaluations have shown that the behaviour of properly trained staff positively influences the behaviour of the other people present in a building. The people present can use escape strategies and evacuation procedures to obtain information about the emergency situation. This additional information is found to be highly relevant to the fleeing behaviour of the people present in a building. An analysis of the most fatal fires in the Netherlands has shown that there was often no in-house emergency response organisation or only a very poorly functioning one. Information that is available on the response times in office buildings and shops shows that the actions of properly educated and trained in-house emergency responders may significantly shorten response times (up to ten times shorter).

The influence of human behaviour cannot be quantified unambiguously when compared to the applicable building regulations. This requires an approach based on a model (see chapter 3 and annex B).

## 5. Classification of fire risks in buildings

This classification is about risks that are known. The first person who is responsible for controlling any risk is the occupant of a building.

Risk control with the objective of preventing casualties and preventing damage to adjoining buildings by fire is not only a private matter, but also a government matter. Statutory regulations, e.g. the provisions of the Dutch building decree, set out to restrict these risks by provisions and instructions for fire protection measures and facilities.

The parties involved, such as designers, advisers and assessors, recognise and confirm the risks. Making people safe is also one of their first concerns. However, they find it harder to identify with the rule-based and rigid approach to risks taken in the building regulations. In situations where the design of a building, or parts of the design, does not or do not match the scope of statutory instructions, they invoke the principle of equivalence and they often choose a risk-based approach.



A risk-based approach is necessary to control the risk of damage in buildings and also to reduce damage. A pre-condition for such an approach is that there must be clarity as to the result to be reached in terms of damage reduction. Risk control in order to minimise fire damage to buildings is a private matter that is not covered by this document.

## 5.1 Classification of risks

Fires often have fatal consequences. Studies, literature and practical experience have shown that buildings involve fire risks and that fire safety mainly depends on the human factor. It is inevitable that there will always be a residual risk. Zero risk, i.e. 100% fire safety, is not possible, but reducing the risks to a socially acceptable level by implementing fire safety measures and facilities is. Risk reduction is the central theme when implementing fire safety. Risk reduction is directly related to, and serves, the main objectives of fire safety that are aimed at:

- preventing fire
- safely fleeing from a fire
- containing fire
- safe and effective intervention in the event of a fire by internal emergency responders and the fire service.

To be perfectly clear: trying to limit fire and smoke is part of the main objectives.

Risks in buildings are determined by the building as such in association with the circumstances of people's presence in the building. These are primary risks. They form the benchmark for the measures and facilities that are to be implemented in the building. In practice, these risks are always known to a certain extent prior to designing a building. But the risks that occur after the design and building phases are not always clear. These risks result from how the building is fitted out and is used and can be characterised as secondary risks. An optimum alignment of primary and secondary risks is a pre-condition for enabling fire safety to be adequately ensured. There is then an integral assessment of building methods and a building's use. They are inseparably connected to each other. Insufficient alignment of primary and secondary risks may result in an unsafe situation. Please note that the distinction between primary and secondary does not indicate a difference in the degree of importance, but in the time sequence. The following subsections describe the risks of buildings. This has been limited to a couple of examples for the secondary risks. See the box below for the most effective method.

The most effective method of reducing risks is to reduce the probability of fire as much as possible, since if no fire breaks out, there will be no consequences.

### 5.1.1 The building

Buildings come in many shapes and sizes. There are large buildings, small buildings, high buildings, underground buildings and/or buildings with large non-compartmented surfaces and buildings with a special building volume. Buildings may also have a complex layout. The different types of buildings have different risks. High buildings involve higher risks than low buildings. The higher the building is, the more difficult evacuation and providing assistance become. Buildings that are located underground involve a higher risk than above-ground buildings. The higher risk is partly the result of the fire characteristics. Heat and smoke rise, making it more difficult to escape from the building and making it harder for the fire service to provide assistance. The risk of a large fire is greater in buildings with large, non-compartmented surfaces, than in buildings with smaller surfaces. The more complex a building's layout, the higher the risk will be. A building that is clearly laid out lets people find their way out much more easily.

### 5.1.2 The circumstances of people's presence in the building

The circumstances of people's presence in a building influence the risks in a building. This is the case if people in the building are sleeping and/or are not able to leave without assistance. This also applies to situations where many people are present in a limited area and/or where people are present in a building without other people being aware of their presence. See figure 56 Risk themes and risk factors (primary).





### **Awake – sleeping**

People who are present in a building may be awake or sleeping. The risk is greater if the people who are present are sleeping. The reason for this is the lower degree of alertness of people who are sleeping or who have just woken up. This means that their reaction time, and by extension the time they need to escape to safety, will be longer. A hotel is an example of a building where this situation occurs.

### **Able to leave without assistance – not able to leave without assistance**

A person's ability or inability to flee on their own is an important risk indication. People who are not able to flee on their own are not able to leave without assistance and run a greater risk than people who are able to do so. A hospital is a good example of a building where this situation may be found, as many patients will not be able to leave without assistance. A prison is another such example. Although the inmates are able to leave without assistance in principle, they are prevented from doing so. This is identified as being 'prevented from being able to leave without assistance' instead of 'not being able to leave without assistance'. Both patients and inmates depend on other people for evacuation.

### **Low occupancy – high occupancy**

Many people in a limited area (number of people per m<sup>2</sup>) is identified as high occupancy; here the risk is greater than with low occupancy. The higher the occupancy, the more people there will be in a certain area and the more they will hinder each other in their attempts to flee. Their walking speed will become slower and it will take longer for them to reach safety. If occupancy is very high, the walking speed may reduce to zero.

### **Familiar – not familiar**

People who are familiar with a building will be better able to find their way than people who are not familiar with the building. Unfamiliarity leads to a greater risk indication.

### **Consideration of 'building' and 'circumstances of people's presence in the building'**

The primary risk factors are relevant when considering the 'building' and the 'circumstances of people's presence in the building'. Combinations of risk factors might reinforce individual factors, e.g. in a building with high occupancy, a complex layout and people being present without others being aware of their presence. Another example is a building where people are sleeping and are not able to leave without assistance. The primary risk factors take precedence when determining the necessary fire protection measures and facilities for all buildings. They have to fit in with the main objectives of fire safety.



Building with people who cannot leave without assistance and with sleeping facilities

Risk themes	Risk factors (primary)
Building	High
	Underground
	Special building volume
	Large non-compartmented areas
	Complex building layout
Circumstances of people's presence in the building	Sleeping
	Not able to flee without help (not able to leave without assistance)
	High occupancy
	Present without others being aware of this

Figure 56 Risk themes and risk factors (primary)

### 5.1.3 Occupancy aspects

The occupancy, fixtures and fittings and the circumstances of people's presence in the building may cause risks. These risks are inseparably attached to the primary risks. See figure 57 Risk themes and risk factors (secondary).

#### *Fire-safe use*

Wrong use of the building involves risks. An example of an occupancy aspect is escape routes being obstructed by obstacles such as beds and other furniture.

#### *Fixtures and fittings*

The fire behaviour is a risk factor for the fixtures and fittings. The higher the combustibility and smoke development of the fixtures and fittings, the greater the risk will be. Examples of such fixtures and fittings are furniture, curtains, mattresses and decorations.

#### *State of people's presence in the building*

A person's state of presence in the building may negatively affect their escape safety, leading to a higher risk. Alcohol and/or substance abuse and the use of certain medication affect a person's responsiveness.

Risk themes	Risk factors (secondary) This list serves as an example and is not exhaustive
Building	Escape routes being obstructed
Fixtures and fittings	Fixtures and fittings with fast fire spread, e.g. furniture
State of people's presence in the building	Alcohol and/or substance abuse
	Use of medication

Figure 57 Risk themes and risk factors (secondary)

### 5.1.4 The human factor

In addition to the risk factors mentioned above, people's behaviour plays a role during the escape and evacuation process (see section 4).

## 6. Translating risks into protection options

A risk approach is about determining the extent of the risks and then translating them into protection options. As yet, the assessment method is a qualitative method that requires another way of working than the current practice that is mainly based on applying rules. The aggregate risk equals the sum of the individual risks. Individual risks can be assessed and ranked according to their importance. All individual risks can be assessed to determine their applicability.

A suitable risk approach method is based on the analysis of scenarios. This method can only be applied if fire scenarios are available in combination with the analysis methods. Commonly used analysis methods are based on a risk matrix and an event tree. Both methods greatly simplify the real world situation. A risk approach involves assigning probabilities to protection options or to parts thereof.

## 6.1 Fire scenarios

Fire scenarios are a pre-condition for a risk-based approach to fire safety. In other words: risk analysis is not possible without these scenarios. Scenarios identify the norm for the fire protection measures and facilities that are to be implemented. Designing fire scenarios requires a sound knowledge of fire and of the consequences of fire. Scenarios can be designed using retrospective and prospective methods.

The retrospective method looks at the past: this concerns fire risks that are known. This method uses information about fires that have been documented in case histories and statistics. Studies that include fire tests and trials can also serve as sources of information. The information is used as the basis for estimating the probability of fire occurring in buildings and the impacts of such a fire.

Examples of sources of information are:

- The statistics of fires held by Statistics Netherlands (CBS).
- Report on fatal fires in homes from the Netherlands Institute for Safety.
- International statistics.
- Research reports by the Dutch Safety Board and national government inspections, such as the Dutch Security and Justice Inspectorate.
- Research reports by Efectis Nederland bv and reports by comparable organisations.
- International research reports.

A scenario provides an understanding of the development, the size and the consequences of a fire. A fire scenario is defined as follows:

A fire scenario is a theoretical description of a realistically imaginable fire based on some pre-selected factors that determine the growth and the development of a fire (and smoke) resulting in the consequences of such fire for the people in the building, the fixtures and fittings of the building and the actual building. (*Fire protection concepts*)

Due to the many factors that may determine the occurrence and development of a fire, many different fire scenarios can be drawn up, but only the scenarios with considerable consequences are relevant.

The prospective method is a method of predicting fire scenarios that have never occurred. This does not concern known fire risks. The question is whether such 'imaginary' scenarios are relevant to the eventual risk level.

This depends on the probability of such a scenario occurring and of its consequences. Not involving prospective scenarios in a risk analysis because they look unrealistic may lead to the risk being underestimated.

## 6.2 Probability-impact matrix

A probability-impact matrix enables the probability and the seriousness of a risk to be related to each other. The key issue when using the model is the question of how probable it is that a certain event, in this case a fire, will have a certain impact. This cannot be determined exactly. If this model is applied with sufficient expertise, it is very useful for a probabilistic qualitative approach. A further elaboration of the model can be found in figure 58. The model consists of a coordinate system where the vertical axis shows the impact, i.e. the consequences of fire, from unimportant to average to serious. The horizontal axis identifies the probability of the impact, in terms of highly improbable to possible to highly probable. Application of the model involves three steps.

### *First step*

Initially this concerns identifying one or more events that require information to be provided on their probability and impact combinations. An example: the ability of a certain construction to offer sufficient resistance to fire and smoke in relation to escape safety.

### *Second step*

The next thing to be considered is the coordinate system's classification of categories. For the time being, the horizontal axis runs from highly improbable to highly probable and the vertical axis runs from unimportant to serious. However, other possible configurations are definitely possible. An example would be to express the horizontal axis as a percentage with intervals of 10 or 20% and to put the casualties and/or damage along the vertical axis.

### *Third step*

In the third step, the events are positioned in the matrix and it is determined whether any measures and facilities (protection options) are necessary and if so, what they are.

The risk/probability in the bottom left-hand corner of the matrix is negligible or low. No protection needs to be provided against this. The risk/probability in the top right-hand corner is high and unacceptable. Protection must always be provided against this. What remains is the manner in which the protection options are implemented.

The transitional area is the most interesting part of the matrix. This area is about answering the question of whether a certain fire safety measure and/or facility is useful and if so, whether it is sufficiently reliable. To help answer this question, risks are assessed on the basis of the probability of

failure and consequences. A probability-impact matrix is often used as part of an iterative process in a combination of risk factors.

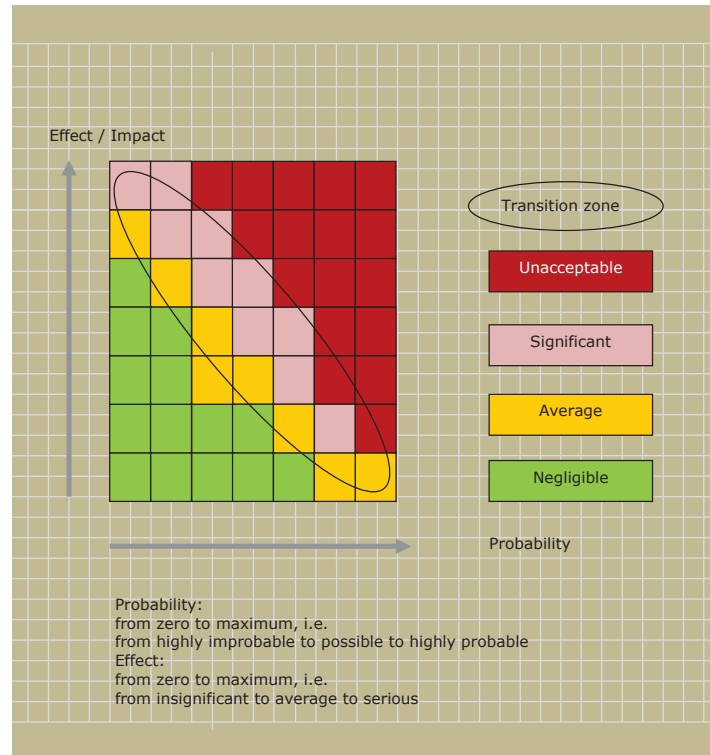


Figure 58 Probability-impact matrix

### 6.3 Event tree

An event tree, i.e. the right-hand side of the bow tie model, enables events that occur during a fire to be put in logical order and enables the possible consequences of a certain group of events to be identified.

Comparing different groups of events and their consequences to each other may enable choices to be made. Sub-events play a role in the group of events, with individual risk assessments applying to the different sub-events. Sub-events can be assessed using the probability-impact matrix method.

The event tree has three steps that are identified and commented on below. For the event tree, see figure 59.

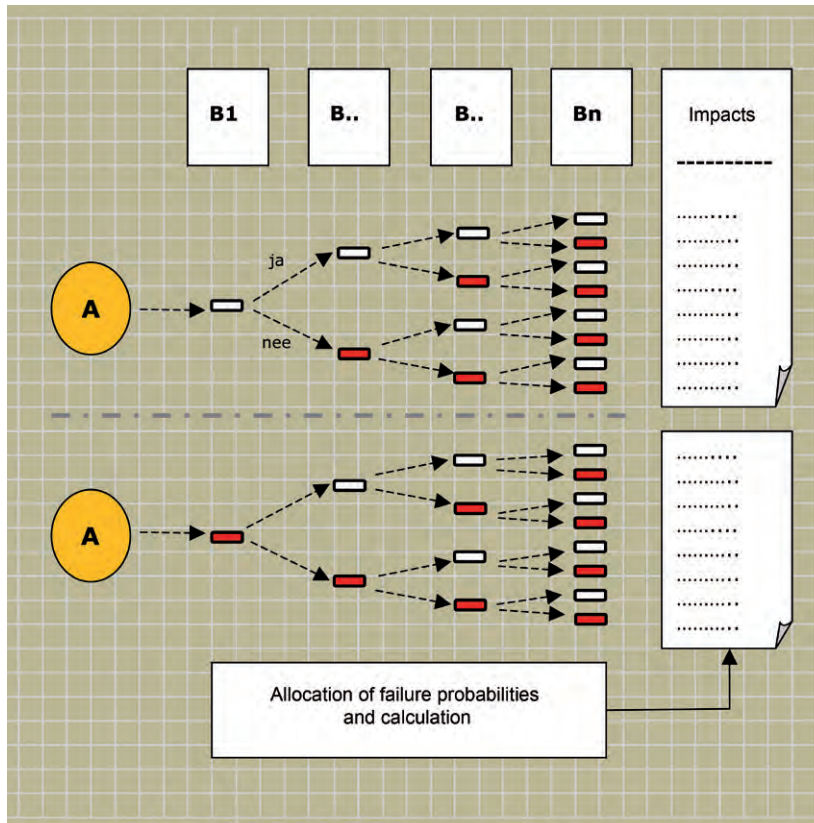


Figure 59 Event tree

### First step

The first step is the initial event, a fire (A in the figure).

Unless the initial event does not occur or its consequences are negligible, it is assumed that the initial event takes place. Current knowledge is not yet sufficient to enable a risk differentiation for the occurrence of fire. And furthermore, the event tree method makes no sense without an initial event.

### Second step

The second step is adding lines of defence, i.e. the fire protection measures and facilities. This addition concerns the impact events (B1 to Bn in figure 59). The B's concerns the implementation of measures and/or facilities in order to prevent the next event or to reduce it as far as possible. This may lead to different consequences for every branch of the event tree.

The size of an event tree is defined by the desired level of detailing. The different types of B's and their mutual correlation can be quite considerable. In theory there are numerous possibilities. Reducing the number of B's is important as this improves the transparency of the tree structure. The B's must be ordered in a logical sequence, based on cause and effect, and there must be clarity about the themes that are to be analysed on the basis of their impact. Such themes may be escape safety, buildings in the direct vicinity, intervention by the in-house emergency assistance organisation,



intervention by the fire service and/or private damage prevention. The costs of the protection options may be considered here as well. Drawing up several transparent event trees is preferred over a single non-transparent event tree.

The figure shows four B's, leading to eight results. Five B's would lead to sixteen results. Examples of B's are such themes as the use of an automatic fire alarm system, the manner of reporting to a control room, fire compartmentation, an automatic fire suppression system, the in-house emergency responders and the fire service. It may also be desirable to differentiate between several situations, e.g. a day-time and night-time situation and/or a rapid fire and a slow fire.

### **Third step**

The third step is studying whether the impact event actually occurs. Awarding probabilities to the impact event forms part of this step. These probabilities are multiplied to quantify the probability for every branch of the event tree to enable comparisons. It is obvious that this will also be the case if several event trees are drawn up. This method is characterised as semi-quantified. The results of the third step yield material for comparison, resulting in options to enable different choices to be made.



## 7. Risks and buildings

Assuming that good protection of a building against fire is possible, the risks in a building are then determined to a great extent by the circumstances of people's presence in the building. These risks are people-related. An important protection aspect is that people should be able to reach a safe place in good time and safely if a fire breaks out. From this perspective, it is advisable that, for the purposes of fire protection of buildings, a distinction is made between buildings with people in them who can leave without assistance, and who may be sleeping, and buildings with people in them who are not able to reach safety on their own.

The difference indicates the type of building. Buildings can be categorised into groups by linking risks to types of buildings. The decisive risk factors are the circumstances of people's presence in a building. Figure 60 provides a classification. Types of buildings are then linked to the groups. Residential buildings and homes have been included as a separate category since their residents are familiar with their living environment and furnish their own homes.

Building group	Dominant risk factors	Type of building
1	people who can leave without assistance	office buildings educational buildings public buildings industrial buildings
2	people who can leave without assistance, sleeping	guest accommodation buildings
3	people who cannot leave without assistance, sleeping	healthcare buildings cells and buildings housing cells
4	residents who can leave without assistance, sleeping	residential buildings and homes

**Figure 60** Groups 1 - 4: risk factors and the relevant types of buildings

Note to the figure:

Only a limited number and range of building types are listed here. See annex A for profiles of the different types of buildings. This includes buildings intended for special accommodation, such as residential care buildings and nurseries. The current practice in the sector covering accommodation buildings where care is provided is to combine residential stay and care. The legal context of building regulations often gives rise to the discussion of whether a building is a residential building, an intermediate form, or a healthcare building. Such a discussion based on a purely legal perspective makes little sense from the perspective of providing protection against fire, unless the discussion focuses on the people who are actually at risk. If such people are not able to leave without assistance, or if their ability to leave without assistance is limited, the fire protection

options must be adjusted accordingly. This also applies to nurseries and homes for the elderly. The healthcare provider has great responsibility in this respect.

In addition to the dominant risk factors, there are also other risk factors, such as the presence of large numbers of people, people being present in a building without others being aware of this, and how this relates to human behaviour when fleeing from a building. Industrial buildings also have specific risk factors, e.g. due to a certain production process or due to certain goods being stored in them.

Special accommodation buildings, other than guest accommodation buildings, are buildings where the people at risk sleep, but for whom this is not their regular living situation. An example of a sector where this is applicable is the sector of accommodation buildings where care is provided or where rooms are let. Buildings in these sectors have an extra risk if the 'residents' have to furnish their rooms themselves and/or are able to lock their rooms. And often the 'residents' of such buildings do not assume any responsibility for each other, which is different from regular living situations. In that event also, the protection options must be matched to the people at risk, the 'residents'. As a minimum, the basic assumption should be that the building should be as safe as a regular home.

The risk factors in figure 60 are also expressed, to some extent, in the statutory provisions on building, refurbishing and occupying buildings. For example, buildings in which people sleep have to comply with stricter requirements than buildings where no people sleep. The regulations place higher requirements on hotels than on office buildings, for instance. This is expressed in the requirement to have extra protection form part of the design of hotel rooms and the requirement to have an automatic fire alarm system. Buildings where people sleep and who are not able to flee the building without the help of others are subject to stricter requirements than buildings where people only sleep. One of the ways in which this is expressed is by extra architectural requirements for evacuations, such as evacuation partitions to enable people to be moved through the building horizontally. Examples of risk factors that are not expressed in statutory schemes, or that are only expressed to a limited or insufficient extent, are the risks that result from high occupancy, a complex layout and people's unfamiliarity with the building. People's reaction to fire plays a crucial role that has not been taken into consideration in statutory schemes. These risks require a different kind of approach to fire safety than the current approach, i.e. a risk-based approach.

Table 1 shows a model for the risk indication of buildings. This model enables a transparent risk assessment to be made, which will generate information that can be applied in a risk analysis (often probabilistic and qualitative). People's circumstances and behaviour are important factors here.

Making an analysis is about assessing the risks as they correlate with each other by matching the risks of the building against the risks that people will fall victim to the effects of a fire. Events and how they are influenced by fire safety measures and facilities, the protection options, play a key role while performing an analysis. Failure probabilities can be assigned to protection options to enable several options to be compared to each other. A similar method can be applied in order to limit the damage. The risks of the building must then be compared with the risks of damage.

Using a risk indication model forces people to think about fire safety in terms of risks and serves as a guide when assessing the various risk factors. The model may be expanded for buildings with specific risks. Analysing the risk factors identified produces a risk profile of the building that is to be made safe. The fire protection measures and facilities to be implemented should match the risk profile.


Please remember that individual buildings are actually often combinations of several types of buildings, for instance a combination of office and public functions.





Building where people are present without others being aware of their presence

**Table 1** Risk indication model

Type of building	Risk theme					Human
	Building					
	Risk factors (primary)					
	High	Under-ground	Special building volume	Large non-compartmented areas	Complex layout	
Office						
Education						
Public						
Guest accommodation						
Health care						
Cells						
Industry (storage)						
Industry (production)						
Living						
Special accommodation						
. Residential care						
. Nurseries						
. Letting rooms						
	Notes:					
	<b>State of people's presence in the building</b>					
	Risk factors (primary)					
	Sleeping	Not able to leave without assistance	High occupancy	Present without others knowing this		
Notes:						
<b>Occupancy</b>						
Risk factors (secondary)						
Fire-unsafe use	Fixtures and fittings	State of people's presence in the building				
Notes:						
<b>Impression of people's behaviour</b>						
Notes:						

<b>Building</b>	
Type	Mark the type of building. E.g. mark guest accommodation building (hotel) by a √.
High	Mark high. E.g. draw an X if the building qualifies as a high building. Note: The reference for marking the building as a high building is 50 metres. Below this threshold, height is not a special risk. The height threshold of 50 metres equals about 15 storeys.
Underground	Mark underground E.g. mark an X if storeys are located underground. Note: The indication for marking is 1 or more underground storeys. Above this threshold does not qualify as a special risk.
Special building volume	Mark special building volume. E.g. by means of an X if relevant.
Large non-compartmented areas	Mark large non-compartmented areas. E.g. by means of an X if relevant. Note: An indication for marking are areas of more than 1,000 m <sup>2</sup> . Areas may also be located on more than one storey (atrium-type construction). For risk indication, there is a relationship here with the occurrence of large-scale fires and possibly in combination with escape safety.
Complex layout	Mark complex layout. E.g. by means of an X if relevant. Note: It is hard to describe exactly what a complex layout is. See 5.1.1 of this section. Examples of complex layouts are buildings with hard to understand floor plans, resulting in greater risks as regards escape safety and emergency assistance.
Notes	The 'notes' box can be used for a further explanation of the building's risk factors and for listing extra risk factors, e.g. those concerning: <ul style="list-style-type: none"> <li>- the people at risk (in the building)</li> <li>- any combination of building purposes that lead to extra risks.</li> </ul>
<b>State of people's presence in the building</b>	
Sleeping	Except high occupancy and not being able to leave without assistance, these risk factors are easy to indicate and to mark. E.g. by means of an X if relevant. Note: <ul style="list-style-type: none"> <li>- see section 4 for people who cannot leave without assistance</li> <li>- indication for high occupancy / number of people per m<sup>2</sup></li> <li>- in the context of escape safety, it is noted that the occupancy of escape routes may increase when evacuating the building, resulting in lower walking speeds.</li> </ul>
Not able to leave without assistance	
High occupancy	
Present without others being aware	
Notes	The 'notes' box can be used for a further explanation of the risk factors of people's state of presence.
<b>Occupancy</b>	
Fire-unsafe use	These risk factors are harder to indicate and mark because they usually occur later in time in a real world situation. For reasons of escape safety, this must be given proper attention and in good time.
Fixtures and fittings	
State of people's presence in the building	
Notes	The 'notes' box can be used for a further explanation of the occupancy risk factors.
<b>Human behaviour</b>	
Notes	Form an impression of human behaviour in connection with the above risk factors

## 8. Fire causes and consequences

Statistics and case histories are important tools and indicators for determining risks. This also applies to the risks of fire and the consequences of fire. However, neither of them has been developed sufficiently yet. The statistics provided by Statistics Netherlands are incomplete. An improvement is being worked on and better fire statistics are expected to be available with effect from 2016. Case histories have been structurally gathered by fire research teams of the Dutch fire service in some pilot areas for some years. The Fire Prevention professorship of the Netherlands Institute for Safety (NIFV) structurally gathers data on fatal casualties due to fires.

The average number of people dying in a fire over the past ten years has been 53. This is a slight drop compared to previous years. Compared to other countries, the risk of the consequences of fire, measured in terms of the number of people dying in a fire, is low in the Netherlands. The number of people who die in a fire in the Netherlands every year is just below four in every one million inhabitants. The average number in the European Union is 12, with considerably fewer casualties in western and southern Europe than in the northern and eastern parts. The EU actually has a good 'score' compared to other European countries and Northern America. There are no reliable figures on the number of people who are injured in fires; literature shows that this number is about ten times higher than the number of fatal casualties.

There are some 14,000 fires in buildings in the Netherlands every year. Half of them take place in buildings with a residential purpose. More than half of the 7,000 fires in non-residential buildings a year occur in industrial buildings, healthcare buildings and venue buildings. Fires in buildings housing cells and educational buildings are often caused by arson.

By analogy with the classification into types of buildings from figure 60, a classification of causes and consequences for individual types of buildings and a classification of the risks for fire service personnel when taking repressive action in them is provided below. To give a more complete picture, the case histories of fires have been included in annex C to complement the classification that has been described in this section. The intention is to keep this as up to date as possible.

### 8.1 Causes and effects per type of building

#### *Office buildings, educational buildings, public buildings and industrial buildings with people who can leave without assistance*

Most building purposes fall into this building type. The number of injuries and deaths in this group has been decreasing for years. During the past ten years, the number of fatalities in this category in the Netherlands was 5 a year, including the pub fire in Volendam where 14 people lost their lives, seven of whom were firefighters. The fatalities occurred in industrial buildings (24) and in public buildings (27), where shop buildings accounted for four fatalities. This means that educational buildings, sports buildings

and office buildings did not claim any casualties in this period. Statistics lead to the conclusion that venue buildings and industrial buildings are buildings with people who can leave without assistance in them and that pose the highest risks. For public buildings, this can be explained by their often high occupancy. The casualties in industrial buildings were not so much due to fires, but due to explosions caused by work processes, which also led to fire. This means that the process in the building leads to more risks than the building itself.

### ***Guest accommodation buildings, people who can leave without assistance, sleeping***

The last major hotel fires in the Netherlands date from the 1970s ('t Silveren Seepaerd hotel in Eindhoven where 11 people died; Hotel Polen in Amsterdam where 33 people lost their lives). Fire safety in guest accommodation buildings has improved since those days. Only two people have died in hotel fires in the Netherlands in the past ten years. Some 300 hotel fires occur in the Netherlands every year. As regards the risk, statistics do not supply sufficient information. Studies by the NIFV into people's ability to leave without assistance have shown that hotel guests' fleeing behaviour leaves much to be desired. This is also confirmed by practical situations encountered by the Amsterdam fire service and other parties. This means that guest accommodation buildings continue to be a high-risk category where safety gains can mainly be achieved by positively influencing hotel guests' behaviour and, along the same lines, by improving the hotel management's sense of responsibility.

### ***Healthcare buildings, cells and buildings housing cells, with people who cannot leave without assistance, sleeping***

There are people who cannot leave without assistance and who are sleeping in these types of buildings. This makes it a high-risk group of buildings by definition. Over 1,000 fires in healthcare buildings and some 300 fires in buildings housing cells are reported to the fire service every year. In the past ten years, fires in healthcare buildings have claimed ten lives and fires in buildings housing cells 11. These latter 11 casualties were all in one fire. The relatively large number of incidents combined with the vulnerability of the people present in a fire means that this category presents a great risk of an incident with many casualties. Experiences in other countries have shown the same results.

### ***Homes and residential buildings, with residents who can leave without assistance, sleeping***

Starting from statistics and case histories, the residential environment is found to be the most high-risk environment of all types of buildings. Of course, this is mainly because of the large number of homes in the Netherlands: seven million, resulting in 7,000 fires being reported to the fire service every year. Over the last 10 years, the average number of fatalities in fires in people's homes was 46.



The slow fall in fatalities and casualties that can be seen in the other building purposes is not occurring in buildings with a residential use. As a result, the percentage of fatalities and casualties in this category has also been increasing, compared to the figures for the other types of buildings. Only 25 years ago, two thirds of the people who were injured or died in a fire were victims of a fire in the home. After the 1990s that changed into three quarters and in recent years it has gone up to 90%.

A relatively large number of people who lose their lives in a fire in the home are 65 or older. Relatively speaking, this means that three times as many people aged 65 or above die in a fire than people below 65. As the population of the Netherlands is ageing more, and the government's policy is to have people continue to live in their own homes for as long as possible, this means that the risk in people's living environment will increase. Developments in construction methods and home fixtures and fittings increase the risks of fire in homes that spread fast and that may be fatal, and this is where the greatest challenge lies for risk reduction.

## 8.2 Risks for fire service personnel

Statistically speaking, repressive action by the fire service is a high-risk activity. Every year, one in 20,000 firefighters dies while fighting a fire. Given the two hours a week that an average firefighter actually spends fighting fire, this is a relatively high number. Relatively speaking, the accident rate is even higher than in the construction industry. There are 28,000 firefighters in the Netherlands, implying that, on average, one firefighter a year is killed in action. Firefighters have died in all phases of firefighting, i.e. during the assessment phase, the rescuing phase, the fire suppression phase and, while damping down the scene of a fire.

Fatal accidents to fire service personnel have occurred in all the types of buildings identified. In the past 25 years, 72% of all firefighters who were killed died in buildings where there were people who could leave without assistance (44% of this 72% concerned industrial buildings), 6% died in buildings where people were sleeping who could leave without assistance, 4% in buildings where people were sleeping who were not able to leave without assistance, and 6% in buildings with a residential purpose. The differences are mainly due to the differences in the numbers of buildings in these categories. The conclusion is that few firefighters are killed in residential buildings and relatively many in industrial buildings. This can be explained by the size of the buildings in question. Industrial buildings cover a large area, leading to higher risks while searching them and to higher risks of fire and smoke spreading. The opposite applies to small homes and residential buildings.

**Chapter 6**  
**Statutory framework and objectives of fire prevention**





## Introduction

This chapter addresses the statutory framework and the objectives of fire prevention in an attempt to review and provide further clarity about the scope of public documents and their cross-correlation. Section 1 discusses the general assumptions for fire prevention in buildings. Section 2 focuses on the main building, working conditions and fire service assistance regulations in the public domain. Defining objectives and/or tasks are important elements of these schemes. The private domain that focuses on preventing damage is discussed in section 3. This is only a brief discussion since preventing damage due to fire is outside the scope of this document. Attention is paid to the interagency coordination between the private and public domains. Given the integrated character that is inherent in a building's fire safety level, section 4 reviews the statutory regulations, and their interrelationships, stipulating rules on building, working conditions and assistance by the fire service. And finally, section 5 discusses the main objectives of fire prevention in buildings, based on an analysis of the general assumptions and the statutory regulations.

### 1. General assumptions for fire prevention in buildings

The general assumptions for fire prevention in buildings have been derived from the series of fire protection concepts published by the Dutch government (through the former Dutch Ministry of the Interior) in the 1990s. These concepts show that fire prevention in buildings aims to prevent people from being killed or injured and to limit any undesirable consequences of uncontrolled fire spread. See the figure below.

General assumptions for fire prevention in buildings	
1	Preventing people from being killed or injured
2	Limiting undesirable consequences of uncontrolled fire spread

**Figure 61** General assumptions for fire prevention in buildings

As regards fire prevention, the abstract wording of the general assumptions raises questions as to how to provide a certain level of fire safety, i.e. which fire protection measures and facilities should be used. This question can only be answered if sufficient information about the objectives of fire prevention is available. Simply put, two parties are involved in fire prevention, i.e. parties from the public and from the private domains. The public domain acts in the general interests and the private domain acts in the interest of individual parties. Legislation plays a central role in the public domain. The general assumptions have been anchored and defined in legislation.

## 2. The public domain

The Dutch government has identified safety as a core task and fire safety is a part of this task. The government regulates fire prevention in buildings by means of a system of legislation and regulations that stipulates the minimum requirements for achieving the objectives it envisages. Regulations on construction, furnishing, occupying and using buildings and on internal and external emergency response are laid down in the following three statutory schemes:

- building regulations
- regulations on working conditions
- fire service assistance regulations.

The provisions of the Dutch Environmental Management Act (*Wet milieubeheer*) and the Commodities Act (*Warenwet*) also apply. The latter act contains rules on product safety and protects consumers against unsafe or hazardous products, including inflammable products.

### 2.1 Building regulations

The key terms featured in the Dutch building regulations include building, construction, planning permission, and occupancy permit. These regulations form part of the system of schemes pursuant to the Dutch Environmental Permitting (General Provisions) Act (*Wet algemene bepalingen omgevingsrecht - Wabo*). Pursuant to the Dutch Housing Act (*Woningwet*), the Dutch Building Decree (*Bouwbesluit*) provides specific technical instructions on building, occupying and using building structures.

#### 2.1.1 Environmental Permitting (General Provisions) Act

The Dutch Environmental Permitting (General Provisions) Act took effect in October 2010. This act governs such issues as planning permission, environmental permits and listed building consent that are brought together in one integrated permit, the 'environmental permit for physically location-specific projects'. The Living Environment Law Decree (*Besluit omgevingsrecht (Bor)*) and the ministerial regulation on environment law (*ministeriële regeling omgevingsrecht (Mor)*) have been drawn up in order to implement the provisions of the Dutch Environmental Permitting (General Provisions) Act. The *Bor* contains stipulations on, for example, the obligation to obtain a permit, whereas the *Mor* addresses such issues as the filing requirements, including those relating to building and fire-safe occupancy.



### 2.1.2 Housing Act and Building Decree

Section 1a of the Dutch Housing Act stipulates that the owner of a building or an open plot or grounds or any party authorised to implement facilities in or on such building, plot or grounds ensures that the state of the building or the plot or grounds is such that it neither creates any danger to public health or safety, nor allows such danger to continue. Furthermore, it stipulates that whoever builds, occupies or demolishes a building or allows a building to be occupied or who occupies an open plot or grounds or allows such plot or grounds to be occupied shall ensure, as far as lies within their capacity, that such building, occupancy or demolition neither creates any danger to public health or safety, nor allows such danger to continue.

Pursuant to the Dutch Housing Act (*Woningwet*), specific technical instructions on building, occupying and using building structures have been drawn up. The building rules, including those on fire safety, the rules on systems and the occupancy rules for the fire safe use of buildings are in the Building Decree.

In principle, these rules have been worded as functional requirements on the basis of which performance requirements have been drawn up. An assessment method in the form of a standard is often linked to the performance requirements. At various points in the Building Decree, use has been made of the possibility of providing rules by way of a ministerial regulation. Such rules concern the application of standards and connection conditions.

The Building Decree is subdivided into rules on new build, alteration or renovation, temporary buildings and existing buildings. The rules represent a fire safety level that depends on the subdivision. The highest level of facilities required is applied to new build, whereas the lowest permissible

level is applied to existing buildings. The level of the fire safety rules is not based on any risk assessment or analysis. The level contained in the rules is mainly based on history, acquired rights, feasibility and experiences.

If a building cannot comply with the performance requirements or if the assessment method of the decree cannot be applied as such, equivalence may be invoked. In that event, the applicant has to demonstrate that at least the same level of safety is achieved as is envisaged by the regulations. See chapter 2 for further information about equivalence.

Based on section 13 of the Dutch Housing Act, the authorities can order the owner of an existing building to implement extra facilities in addition to the rules on existing buildings in the Building Decree. The level of such facilities must not exceed that of new build. Any use of the authority to issue such instruction must always be substantiated for the specific situation, applied consistently and is a means of last resort.

Trying to convince the owner of a building that they should voluntarily apply such facilities or adjust or cease their use or occupancy of the building is preferred.

### 2.1.3 Municipal building regulations

Pursuant to the Dutch Housing Act, municipalities have to adopt municipal building regulations. They use the sample municipal building regulations drawn up by the Association of Netherlands Municipalities (*Vereniging van Nederlandse gemeenten - VNG*). These regulations are of little importance to the fire protection of buildings.

### 2.1.4 Objective and basic assumptions of building regulations

The Dutch Housing Act is intended to regulate safe building, rebuilding and the safe state and occupancy of buildings. The main condition is that no health or safety hazards occur (section 1). The general notes to the Building Decree describe the objective of fire safety rules. See figure 62.

Building Decree. General notes. Objectives of fire safety rules	
1	Preventing casualties (people being killed or injured)
2	Preventing fire from spreading to another plot

**Figure 62** Objective of fire safety rules pursuant to the Building Decree

The Building Decree is not designed to regulate maintenance of buildings or to prevent damage to the environment, listed buildings or public facilities or interests.

As regards fire safety rules, the Building Decree employs general assumptions, subdivided by time for the period from the inception of a fire until the time when the fire is under control. This subdivision is considered necessary in order to comply with the wish to have a general benchmark when drawing up the performance rules.

The general assumptions of the Building Decree are:

- The fire must be discovered, and the people endangered by the fire, as well as the fire service, must be alerted within 15 minutes of the fire starting.
- The people endangered by a fire must be able to flee without the fire service's assistance within 15 minutes of having been alerted.
- The fire service is present and operational within 15 minutes of the fire being reported.
- The fire service must have the fire under control within 60 minutes of the fire starting, which implies that the fire must be prevented from spreading further. At such time, the last people endangered by the fire must have been rescued with the fire service's assistance.

The general assumptions refer to a general benchmark fire scenario with maximum times, based on the performance rules for new build.

What is remarkable is that 'must' is used in combination with the maximum times of the general assumptions. The term 'must' suggests an obligatory maximum time. However, due to the many uncertain factors that play a role in the case of a real fire, actual developments and the associated performance will not always be able to comply with the maximum times stated. Building regulations should not provide compulsory basic assumptions for the results of repressive action by the fire service. The requirements imposed on the fire service should be provided for in the Safety Regions Act (*Wet veiligheidsregio's*).

The Building Decree contains specific rules related to intervention by the fire service. These rules cover structural safety, emergency provision in the event of a fire, suppressing fire and accessibility for emergency services. The rules on dividing a building into fire and smoke sectors, i.e. compartmentation, mainly serve the purpose of evacuation and also provide a safe route of attack for the fire service.

## 2.2 Regulations on working conditions

The regulations on working conditions provide rules on working conditions and attempt to improve working conditions. These regulations focus primarily on employers and employees. The Dutch legislator has opted for a system of sector-specific rules instead of a general, central regulation. In-house emergency response is also covered by this.

### 2.2.1 Dutch Working Conditions Act and Working Conditions Decree

The Dutch Working Conditions Act (*Arbowet*), as revised in 2007, provides goal-based rules. Employers and employees can decide for themselves whether they wish to comply with these rules. The standards from the Dutch Working Conditions Act are the guiding principle; the government, labour and industry are at liberty to draw up a 'working conditions catalogue' for their own sector defining how these standards should be complied with. The provisions of the Dutch Working Conditions Act have been elaborated into rules contained in the Working Conditions Decree (*Arbeidsomstandighedenbesluit*). This decree lists rules which both employees



and employers have to comply with in order to prevent risks in the working environment. There are also rules on working conditions that contain concrete instructions.

Section 3, paragraph 1(e), of the Dutch Working Conditions Act states that adequate measures shall be taken to render first aid in the event of accidents, to arrange for the limiting and fighting of fire and for the evacuation of all employees and other people in the company and to maintain effective connections with the relevant emergency organisations. Pursuant to section 5, an employer shall conduct a risk assessment and evaluation to handle risks in a structured manner and to thus minimise the risk of work-related health problems and accidents.

### 2.2.2 In-house emergency response

In-house emergency response helps to contain safety risks. The policy and the organisation regarding the in-house emergency response stem from the risk assessment and evaluation and focus on the residual risks. An effective in-house emergency response organisation is necessary in order to contain such residual risks. Section 15 of the Dutch Working Conditions Act provides further details about the obligation imposed on the employer to provide internal emergency assistance. See the figure below for the tasks to be performed by the in-house emergency responders.

In-house emergency responders: tasks (minimum tasks)	
1	Providing first aid in the event of an accident
2	Limiting and fighting fire and restricting the consequences of accidents and, in the event of emergency situations, alerting and evacuating all employees and all other people in the company or the establishment.

**Figure 63** In-house emergency responders: tasks

The training, equipment and number of in-house emergency responders must be such that they can properly fulfil their tasks. The in-house emergency response organisation must be tailored to match the nature and scope of activities, the location of the premises and the employees present. The tasks of evacuating the building and suppressing incipient fires are particularly important in respect of fire safety.

Studies of fires, including the studies of the fire in the Schiphol cell complex in 2005, have also addressed the in-house emergency response as provided for in the Dutch Working Conditions Act. In-house emergency responders, which are a compulsory requirement of the Dutch Working Conditions Act, mainly serve to assist employees. This obligation is not sufficient for providing emergency response in situations where the number of non-employees is much greater than the number of employees, nor is it intended as such. This is the case, for example, in places with a lot of spectators, visitors, patients, the residents of nursing homes, pupils or inmates. Because of this it has been decided that basic emergency assistance ought to be provided for in a combined governmental decree based on



the Working Conditions Act, the Housing Act and the Safety Regions Act. This decree is called the Basic Emergency Response Decree (*Besluit basishulpverlening*). It governs situations where people are staying somewhere under somebody else's responsibility. This includes buildings and open areas that are accessible to the public, such as, for instance, outdoor pop concerts. Equivalent to the current provision on in-house emergency response in the Dutch Working Conditions Act, new provisions are worded as goal-based rules as much as possible, so that bespoke solutions are possible. An obligation contained in the rules on basic emergency response is that an internal organisation must be set up to provide first aid in emergency situations, to suppress incipient fires, evacuate people and alert and accompany external emergency services. Its size must be in line with the nature and extent of risks. The Basic Emergency Response Decree is still being drafted.

### 2.2.3 Working conditions catalogue

A working conditions catalogue is drawn up on the initiative of employers and employees, describing how they will comply with the government's goal-based rules. The catalogue describes techniques and methods, standards and practical instructions on health and safety at work for specific companies or business sectors. Since the government assumes that employers and employees are quite capable of drawing up a professional catalogue of working conditions, these catalogues are only checked to a very limited extent by the Dutch Labour Inspectorate. Employers and employees are responsible for the contents and distribution of a working conditions catalogue. Strictly speaking, the term 'working conditions catalogue' does not appear in the Dutch Working Conditions Act. However, an Explanatory Memorandum to the Dutch Working Conditions Act states that such a catalogue may serve as a tool in order to comply with the goal-based rules.

## 2.3 Regulations on the provision of fire services

The actual provision of fire services has been arranged in the Dutch Safety Regions Act. This act envisages efficient and properly organised fire services provision, medical emergency response and crisis management, controlled by one regional administrative body. The starting point is: one fire service organisation for the entire region, led by one regional chief officer. This Act took effect on 1 October 2010 and is based on existing structures. A safety region is a form of extended local administration and has a communal regulation for the legal basis for the safety regions. The Act imposes the obligation on municipalities to endorse this regulation. The law starts from the principle that safety is typically a local matter, but that municipalities are often too small to be able to prepare sufficiently well for all types of fires, disasters and crises. The Dutch Safety Regions Decree (*Besluit veiligheidssregio's*) provides instructions and standards for how to organise basic fire services provision.

### 2.3.1 Safety Regions Act and Safety Regions Decree

One of the aspects governed by the Safety Regions Act is the statutory advisory task of safety regions. This covers all situations where technical advice is required in the context of permit procedures. The statutory advisory task refers to existing advisory tasks that are contained in specific legislation (such as the Public Safety (Establishments) Decree (*Besluit externe veiligheid inrichtingen*) and the Fireworks Decree (*Vuurwerkbesluit*)). Furthermore, based on a regional policy plan, a safety region may provide advice about topics that the region considers are deserving of attention. The governing body of the safety region also has tasks and authorities regarding the fire service. The Safety Regions Act provides demarcation and coordination between those tasks that must absolutely be transferred to the regional fire service and the other fire service tasks which may be carried out by a municipal fire brigade. This strengthens the regional fire service, as instituted in every region pursuant to the Dutch 1985 Fire Services Act (*Brandweerwet*). The Act permits individual differences as regards the organisation of fire service provision in different safety regions.

The Safety Regions Act provides for the tasks of municipalities as regards fire service provision in part 2 on 'The municipality' (section 2.a). These tasks have been defined in more detail in section 3. Figure 64 shows the parts of the fire service tasks that have a bearing on the fire safety of buildings.

Safety Regions Act. Fire services provision: the municipality's tasks	
a	Preventing, limiting and fighting fire, limiting fire hazard, preventing and limiting accidents in the event of fire and everything else associated with it
b	Limiting and fighting hazards for people and animals if incidents other than fire occur

**Figure 64** Fire service provision: parts of fire service tasks

The explanatory notes in the legislation (general notes to planning 4 and section 3.1.a) stipulate that as regards *prevention and reduction*, fire safety has been provided for in a number of Acts, including the Housing Act, the Environmental Management Act and the Spatial Planning Act (*Wet ruimtelijke ordening*). An example: when deciding whether to grant planning permission, fire safety is evaluated in the light of the Building Decree and the municipal building regulations. Based on the notes, stipulating additional requirements on *prevention and reduction* is not possible. The maximum threshold of specific statutory schemes, such as the Building Decree, is the benchmark. This actually also applies to situations where response times are exceeded. However, this does not mean that no other risk management methods are possible. Examples of such methods include:

- The government granting a discount on prices of land for area development in ‘exchange’ for supra-statutory fire safety facilities, such as sprinklers in homes.
- Discussions aimed at compensatory or alternative fire protection options, such that they can be applied on a voluntary basis. Aspects such as the duty of care and sense of responsibility can play a role here.
- In-house emergency responders as an alternative fire protection option. Further studies in this field are necessary before this can be given further substance in the form of specific policy.

Part 4 ‘The fire service’ (section 25.1, a) and b)) of the Safety Regions Act states that the fire service instituted by the governing body of the safety region also has to carry out tasks for fire service provision. Figure 65 shows the parts of the fire service tasks that have a bearing on the fire safety of buildings.

Safety Regions Act. Fire services provision: the fire service's tasks	
a	Preventing, limiting and fighting fire
b	Limiting and fighting hazards for people and animals if incidents other than fire occur

**Figure 65** Fire service provision: parts of fire service tasks

The municipality has to make its contribution to the requirements imposed on the regional fire service. For example, a coverage plan has to be drawn up for every individual region and certain tasks are reserved for the region, e.g. advising other governments and organisations about fire service provision. The regional fire service also carries out tasks in the context of disaster response and crisis management.

Pursuant to section 14 of the Act, the governing body of a safety region has to draw up a policy plan for the tasks of the safety region. This plan contains a description of the envisaged operational performance of the safety region's services and organisations, as well as the response times that apply to the fire service (section 14.1.f). The policy plan is also based on a predefined risk profile that is required pursuant to section 15. The explanatory notes to the Act state that, besides the risk assessment, the risk analysis is also important for the regional policy plan, for such aspects as being able to determine operational performance. After mapping the risk-bearing situations as part of the risk assessment, a list can be drawn up of the types of fires, disasters and crises that might occur in the region. The risk assessment and this list are then used to analyse the risks and estimate the consequences, such as the number of people injured and fatal casualties. The risk assessment and the risk analysis together constitute the risk profile.



Fire service deployment

The Dutch Safety Regions Decree provides instructions and standards for how to organise basic fire services provision. Intervention by the fire service in the event of fires in buildings and laying down the response times are part of the fire service provision. Stakeholder organisations were consulted when drafting the decree. Both the Veiligheidsberaad (Safety Council) and the NVBR (now Brandweer Nederland, the organisation of Dutch Fire Services) have made use of these consultations. They objected to the response times of the fire service as suggested in the draft decree. Their objections have been honoured by introducing the possibility of deviating from these times. The response to their notice of objection states that “risk control in buildings does not fall under the scope of the Safety Regions Act. Fire prevention and other measures have been laid down in the building regulations and on this basis it is not possible to grant the governing body of a safety region the authority to impose stricter requirements on prevention.” The general notes to the Safety Regions Decree state the purpose of the rules on fire service provision. See Figure 66.

Safety Regions Decree. General notes to fire services provision. The purpose of the rules on the provision of fire services is:
The general safety of people in the event of fires and hazards
The saving of lives
Preventing the fire from spreading to adjoining premises
The standards in the decree are not intended to protect private citizens against financial loss.

**Figure 66** General note to rules on fire service provision

### 2.3.2 Assessment of fire risk

The provision of fire services involves costs. The governing body of a safety region has to take decisions on such costs. With respect to the basic fire service response times, the general notes to the Safety Regions Decree stipulate that the organisation of the fire service provision is the result of the governing body weighing up the costs and benefits; this is based on the fire risk assessment that forms part of the risk profile established by the governing body of the safety region pursuant to section 15 of the Safety Regions Act. The optimum spread of fire stations and substations can be determined based on the fire risks combined with the response times. The governing body has the authority to adopt other response times if justified by considering costs and benefits. The response times must be based on the standards included in the decree (section 3.2.1). In so doing, the existing building regulations are taken into account. The 2003 Building Decree and the Decree on Fire Safety in the Occupancy of Buildings (*Besluit brandveilig gebruik bouwwerken*) form the basis of this. Where the building regulations are aimed at occupants and entrepreneurs, the Safety Regions Decree only focuses on the fire service authorities. When deciding on the granting of permits for buildings, it is assumed that the fire service can be present within 30 minutes of the fire’s inception and can start fighting it (see also the basic assumptions of the building regulations). The effect of firefighting

and the possibilities of rescuing any victims decrease as more time elapses. This means that the sooner the fire service arrives and starts fighting the fire, the more effective this will be.

The consideration of costs and benefits by governing bodies on the basis of the fire risk assessment where the existing building regulations have been taken into consideration ensures a certain balance. In general, this leads to commonly accepted and proportional deployment of the fire service. Imbalance might result in other than commonly accepted and disproportionate deployment. Such imbalance may be due to a lack of alignment between the current system of providing a fire service and the current building regulations, e.g. if the size of fire compartments is increased in the building regulations the fire service will have to make a greater effort in the event of a fire than is currently common practice and this will increase the costs of providing a fire service.

The standard response times stated in the Safety Regions Decree have always been based on experience and existing methods. They used to be, and still are, mainly used to help calculate the optimum locations of fire stations rather than hard and fast minutes that serve to indicate what the chance of saving human lives is if the fire service arrives within a certain time.

### **3. Private domain**

The private domain for the fire prevention of buildings concerns those parts in which the government does not play a role or does not want to play a role. The main aspect in this domain is damage prevention. The government considers this to be a voluntary matter. Since damage prevention is not included in the scope of this document, only a few main aspects are described here.

#### **3.1 Preventing damage and loss**

A key issue as regards preventing damage and loss due to fire is whether insurance should be taken out against a certain risk. If this question is answered in the affirmative, it will lead to follow-up questions such as what to insure and under which conditions. The level of facilities (fire protection measures and facilities) required by the government may play a role in this as this also contributes to limiting damage.

Insurers play a central role in damage prevention. A distinction can be made between damage and loss due to fire in terms of economic loss and social loss. Economic loss initially concerns direct damage to buildings and goods or indirect loss (production stagnation, no longer being able to deliver goods and services, etc.). Examples of social loss are irreplaceable goods (such as files and collections) and historic monuments being irretrievably damaged. Besides direct damage to buildings and goods, the victims of a fire may also suffer emotional loss.

### 3.2 Interactions between the public and private domains

Fire prevention in buildings virtually always concerns a combination of public and private interests. From a private point of view, making supra-statutory and/or other kinds of fire protection measures and/or facilities may be desirable or necessary. In such event it is advisable, if not necessary, for stakeholders from private and public organisations to consult with each other so that redundant and/or conflicting fire protection measures and facilities can be prevented. The timing of such consultations is important, but also uncertain since public permit procedures, e.g. for building, and private procedures, e.g. for insurance, do not take place at the same time.

## 4. Review of statutory schemes and their interrelationships

This review addresses building, working conditions and fire service provision regulations and focuses on the objectives and scopes of the schemes. The reason for the review is derived from the integrated character that is inherent in the fire safety level of a building. It is a combination of building and intervention characteristics that is based on several statutory schemes, with human characteristics playing an important role.

Of the three statutory schemes referred to above, the building regulations, and then particularly the Building Decree, are the most tightly organised and most detailed scheme, containing lots of performance rules. The building regulations focus on builders and occupants. The principle of equivalence offers the option of deviating from the rules, provided that the envisaged goal of the rules is achieved.

The working conditions rules are a bespoke scheme with goal-based rules, in which a methodical approach based on a risk assessment and evaluation has been chosen for the in-house emergency responders. Scenarios play an important role in this. This results in these regulations leading to a specific bespoke solution for a building, in line with the actual situation. The working conditions rules primarily focus on employers and employees.

The rules on the provision of fire services provide instructions and standards on organising the basic fire service provision, with goal-based rules and performance standards for response times. The scheme offers the possibility of deviating from the standard response times. Furthermore, fire service provision is part of local decision-making processes. The regulations on fire service provision are aimed at the fire service authorities.

Comparisons have shown that the focus, nature and perspectives of different schemes differ. What they have in common is that safety, including fire safety for people, is their central element and that limiting damage in buildings is not an explicit goal for the government. See the figure below.



The general notes to the Building Decree state, among other things:

“Saving the building and preventing damage to the environment, historic monuments or public facilities or interests are not goals covered by this decree.”

The general notes to the Safety Regions Decree state, among other things:

“The standards contained in this decree do not serve to protect private citizens against financial loss.”

**Figure 67** Fragments from the general notes to the Building Decree and the Safety Regions Decree

In order to assure people's safety – the common aspect of these schemes – these schemes should be considered in association with each other in order to be able to achieve a good prevention result. Relating the fire service response times to the possibility of a successful prevention result as regards people's safety in buildings is an incorrect approach that cannot be substantiated. Linking the response time to the prevention result suggests a certainty that does not actually exist in the real world. This is due to the many uncertain factors that play a role in a fire and in the intervention in the event of a fire. Looking at it this way, from the point of view of prevention, it would be incorrect to take repressive action and therefore the success of repression for granted in advance.

The relationship between fire service response times and limiting damage in buildings is beyond the scope of government objectives. The Building Decree does not envisage preventing damage due to fire in buildings. Nevertheless, many of the fire protection measures and facilities serving to enhance people's safety that are deemed necessary in this scheme contribute to limiting damage. Limiting damage is not the actual goal here, but it is the consequence of applying rules that serve another goal, i.e. people's safety and the safety of the surroundings. An example of this is the necessity of fire compartments in buildings to restrict the possible unhindered spread of a fire to a specific part of the building, ensuring that a fire can be contained, thus assuring the safety of people in other parts of the building. To be able to properly do its work, a fire compartment must not be too large. The scope for limiting and/or containing fire is adjoining buildings and other plots.

The regulations on the provision of fire services clearly state that the standards in the Safety Regions Decree are not intended to protect private citizens against financial loss. In other words: preventing damage in buildings was not an objective of the government when adopting standard response times. However, this does not mean that the fire service will not attempt to suppress fires in buildings. If it did not, all incipient fires

would grow into major fires. The fire service will always make an effort to suppress or contain fires in buildings. The fire service has an obligation in respect of society in this regard. The result of this obligation on the part of the fire service to perform to the best of its ability is hard to predict; no guarantees can be provided. Many factors play a role here, such as the risk setting during a fire combined with the possibility of a safe attack by the fire service.

A typical difference between the building regulations and the regulations on the provision of fire services is that the threshold values in the building regulations aim to enable people to escape safely, whereas the standards in the regulations on the provision of fire services address the operation of the fire service organisation. Saving people from a fire and extinguishing the fire form part of this.

The technical requirements in the building regulations are based on assumptions as to the time needed to be able to safely leave a building. In the majority of cases, people who are able to leave a building without assistance do not need the fire service's help to flee from the building.

If people are unable to flee on their own, as is the case in nurseries, hospitals, nursing homes and prisons, the in-house emergency responders have to take compensatory measures that provide for timely evacuation of the area endangered by the fire. The general notes to the Building Decree state that the fire service might play a role in this. However, that role is limited. The principle is that the in-house emergency response organisation has to evacuate the people endangered by the fire on its own, since the fire service will mostly not have arrived at the moment of evacuating, which is the most crucial moment.

An in-house emergency response organisation cannot be considered as equivalent to a fire service. In-house emergency responders do not have the tools or training to enable them to act under the same high-risk circumstances as the fire service. Given their limited training and equipment, they are not expected to enter a burning room or a room filled with smoke that they cannot see through in order to save a person, unless the fire is still in such an early stage that the temperature and smoke in the room allow this. From this point of view, in-house emergency responders do their work, i.e. evacuating people, in a safe area, whereas the fire service works in an unsafe area in order to rescue people.

The schemes hardly focus at all on preventing fire. They all start from the fact that there is a fire and that intervention is required. From this perspective, providing protection against fire is just a way of fighting symptoms. Preventing fire is better, as this brings maximum safety gains.

## 5. Main objectives of fire prevention in buildings

The main objectives of fire prevention have been determined by comparing the general assumptions for fire prevention, i.e.:

- preventing people from being killed or injured and
- limiting undesired consequences by uncontrolled fire spread to the objectives of:
  - the building regulations and ] and their interrelationships
  - the working conditions regulations ]
  - the fire service regulations.

and then analysing them. These are the main objectives viewed from the public domain.

Main objectives of fire prevention in buildings (public)	
1	Preventing fire
2*)	Safely fleeing from a fire (evacuating / saving)
3*)	Containing fire (no damage prevention in buildings)
4*)	Safe and effective action by internal emergency responders and the fire service in the event of a fire

\*) the numbers do not imply the importance of objectives

**Figure 68** Main objectives of fire prevention in buildings

Fire prevention aims at preventing fire and influencing events if a fire occurs. Its main objectives are providing escape safety in the event of a fire, containing the fire and enabling internal and external emergency responders to respond safely and effectively. Preventing damage in buildings is not among its main objectives.

Due to the scope of this document, no further attention is paid to the private sector, which is concerned with damage prevention. From the perspective of damage prevention, a fifth, private basic assumption might be added to this: 'limiting damage'.

**Chapter 7**  
**Evidence base in**  
**a historical framework**





## Introduction

'Evidence-based' is a buzz word in fire safety, both as regards fire prevention and as regards firefighting. Many people see it as the one and only solution to all fire prevention issues. However, as it requires some refinement, this chapter provides a general exploration and an analysis, followed by a closer discussion of the elementary subjects of fire safety. The key issue in this chapter is the evidence base, starting from historical facts. The conclusion is that substantiations for fire safety do not always require the qualification 'evidence-based'. Often, experience and knowledge can be a good and sometimes even better substantiation of fire prevention measures and facilities. In other cases, scientific research is the best substantiation. Although this has been found to be lacking in some crucial aspects of fire safety, developments and studies that contribute to effective substantiation appear to be ongoing for lots of aspects of fire safety.

Evidence base implies careful, verifiable and systematic substantiation. Since scientific research into fire safety specifically focuses on direct applications of the results, it can by definition be classified as applied scientific research, as distinct from fundamental scientific research whose results do not immediately lead to a practical application.

### 1. The development of fire prevention

Fire prevention is a young discipline. Of course, some fire safety facilities already existed hundreds of years ago, such as the ban on wooden chimney flues and the practice of building stone walls between houses. It was not until the late nineteenth century that people started thinking about preventing and containing fire on a wider scale. Early mediaeval fire prevention measures and facilities were based on preventing fire and containing any fires that did occur, since, in those days, there were very few possibilities of fighting fires and it was a sheer impossibility in the more densely populated urban areas. Every major town or city had its own requirements, but in general they included a ban on wooden and thatched roofs and wooden chimney flues. This applied both to Dutch towns and to such cities as London and New York, where major urban fires regularly razed large areas. Logically, fire prevention requirements in those days were based entirely on prior experience, what would now be termed 'case histories'. It was not until the first half of the twentieth century that the first tentative attempts were made at providing substantiation for fire prevention requirements. Some research was initiated in the United States and on an even smaller scale in the UK, France and Germany.

After the Second World War, the main focus in the Netherlands was on codifying fire prevention requirements and the first real result of this was the 1952 Fire Service Act (*Brandweerwet*). The rules were further expanded into municipal building regulations and in what are now considered to be 'pseudo-regulations' in the 1950s and 1960s. The rules in these municipal building regulations were mainly functional requirements. The fire safety requirements were described in such phrases as "further requirements can be imposed as regards fire safety". In those days, Municipal Executives, actually through the building control departments or fire services, defined which further requirements were imposed on fire safety. Undeniably, performance requirements based on these functional requirements were not, or hardly ever evidence based. There were also major differences between the requirements imposed in the different municipalities, partly due to the above. As a result, these functional requirements were expanded into concrete requirements, identified as performance requirements, in the 1970s. NEN standards, drawn up by the Netherlands Standardization Institute, were primarily used for this. These standards should be administered through the municipal building regulations. At that time, a series of pseudo-regulations was drawn up in which the main fire brigades, working together, played an instrumental part. This series, entitled '*Een brandveilig gebouw*' (A fire-safe building) included publications on 'Designing a fire-safe building', 'Building a fire-safe building', 'Installing a fire-safe building' and 'The surroundings of a fire-safe building'. They have been a great impetus to the uniformity of fire safety requirements in different municipalities. Both the NEN standards and the publications referred to lacked any scientific basis. Although there was a set of reasonably good fire safety rules in the late 1970s, their implementation left a lot to be desired. As a result, the 1980s and the early 1990s were used to stimulate the implementation of fire safety, resulting in such initiatives as municipal fire prevention regulations and the PREVAP (Prevention Activities Plan). This impetus to improve implementation was not directly followed up on in the 1990s, as the focus was shifted to anchoring the fire prevention rules in nationally applicable regulations. The review of the Dutch Housing Act in 1991 brought forth the arrival of the 1992 Building Decree, containing the fire prevention rules applicable to building structures. At the same time, the requirements about fire-safe use (with the occupancy permit system) were transferred from the decree on fire prevention to the municipal building regulations. This review of the Housing Act meant the greatest impetus to fire safety so far. But there was also a downside to this. Since this was the first time that the rules had been defined unambiguously, sticking to the letter of the rule became more important than complying with the spirit of the rule. This resulted in the government adopting considerable, often unrealistic, rigidity when assessing the implementation of the fire prevention rules. The principle of equivalence (the rule does not have to be followed if another solution achieves an equivalent degree of fire safety) was, and still is, not applied sufficiently often. As a result, it looks as if the fire safety requirements became stricter after the adoption of the Building

Decree, but this is not the case. It is their application that has become stricter.

The conclusion is that the last fifty years have seen many impetuses and several approaches to bring fire safety to a higher, and better, level. However, the effects were somewhat limited, due to rules and guidelines being drawn up, to the fire safety requirements being anchored in legislation and to drives to organise enforcements effectively. Nowhere do we see any pressure for evidence-based fire safety requirements in order to assess whether the best choices have been made or to find out if better choices are possible. The negative effects of this now seem to be making themselves felt. After the fire in the cell complex at Schiphol in 2005, there have been intensified calls for increased implementation of a risk approach and for the rule-based approach to be reduced. And evidence-based fire prevention is just what a risk-based approach requires. We must make up for lost time, but it is not too late yet. Fire prevention is a young discipline after all.

## 2. Evidence base

The fire safety measures and facilities prescribed prior to the twentieth century had no scientific basis. Their implementation was based on regular experiences (statistics) and specific experiences (case histories). An example of measures based on regular experiences was the adjustment of the fire inspection by the municipality of The Hague in 1746. The increased use of chimneys and the growing height of homes were a problem in the eighteenth century. The Hague wished to put an end to fire-hazardous chimney structures by changing the rules on the use of chimney and roof materials. A good example of a fire safety facility resulting from case histories is the one implemented in response to the fire in an Amsterdam theatre in 1772. After this fire, an inhabitant of Amsterdam, whose name is lost to history, tried to find a system to bring water into a building as near to the seat of the fire as possible. He came up with a system of trays of water in the attics and pipes with hoses to the lower floors, as a kind of inverted riser or a first indoor fire hydrant. The title of his invention, translated from eighteenth century Dutch, was: *A new invention, based on the laws of physics, to stop the progress of a fire that has occurred, in all kinds of houses and mainly large and public buildings, in the most safe and secure and convenient manner and with the greatest expedience.* After science was tentatively introduced in order to substantiate fire safety in the twentieth century, statistics and case histories have become and still are an important, if not the most important basis for implementing or adjusting fire safety measures and facilities. One method where fire safety measures and facilities are implemented or adjusted on the basis of case histories is currently referred to as the risk-regulation reflex, indicating that incidents often unjustifiably lead to more or different requirements being imposed. Policy makers are then sometimes said to be attempting to prevent the fire or disaster that had already occurred.



The first scientific approaches in thinking about fire prevention, and, following on from that, the scientific influences on fire safety requirements, did not take off in the Netherlands until after the Second World War. Some fire tests to assess the reaction to fire of certain materials had already been conducted in such countries as Germany, the USA and the UK before the war (and even in the late nineteenth century). People also tried to come up with standardised tests. A lot of rebuilding work was required in the Netherlands after the war. Not only was there a severe housing shortage, but lots of business premises also needed to be built and rebuilt in these economically depressed times. It was the government's explicit goal to ease fire safety requirements where possible and as much as possible, relative to the suggestions made by the experts. The emphasis was on 'where possible' since the government wished to maintain the buildings that were to be built for a long time and thought that good fire safety facilities, based on practical experience, were an important condition for this. For example, in the period after the war until 1 January 1948 more farms burnt down than had actually been rebuilt. And 10% of all the industrial buildings that had been rebuilt burnt down in the first years after the war. The Dutch government applied the scientific approach to fire safety to make the fire safety facilities that had been customary so far less burdensome where



Fire resistance test

possible. Initially this approach was restricted to how building materials and structures reacted to being heated up.

Little was known about this shortly after the Second World War. The prevailing opinion in the Netherlands was that there was not a lot to be gained from looking to other countries in this respect, since in those days every country had “its own local materials and structures”. However, the Amsterdam fire service had conducted some primitive fire tests based on the German DIN 4102 standard before the war. These tests were not sufficient to enable general conclusions to be drawn on how materials and structures reacted to fire. The shortage of building materials and their high cost was the reason why lots of materials whose reaction to fire was absolutely unknown were used in buildings in the post-war 'reconstruction years'. Experiences with makeshift fire tests of materials were the only reference point. Calls for better tests grew ever louder.

These developments resulted in a number of standardised research methods, mainly based on information from the USA initially. On the one hand, this was because evidence-based fire prevention measures had already started there before the war, inspired by the many fires with sometimes hundreds of fatalities. On the other hand, policy makers in the Netherlands expected that the building methods and the increased building density that were seen in the USA were also going to find their way into the Netherlands.

## 2.1 Fire resistance

Fire resistance is one of the properties of materials and structures. The Netherlands copied the method that was used in the USA, the UK and Germany to scientifically establish fire resistance until fire spread and failure. 'Fire curves' play a role in determining fire resistance. Since the fire curves were not exactly identical in these countries, the Netherlands opted for the average value of these curves, as a result of which the Dutch models only differed slightly from those elsewhere. The fire curve dates from those days. It is still applied and it relates the period of time to the temperature development of a fire. However, even then, the conclusion was reached that in many cases there was no directly demonstrable relationship between this theoretical fire curve and the real-world situation.

Only in the UK were many wartime fires studied in order to validate the standard fire curve. However, in the Netherlands it was found that the amount of combustible material in buildings in peacetime was very different from that in wartime. For example: storage buildings contained far more goods in wartime, whereas shops had distinctly less stock than in peacetime. The discussion about the discrepancy between the theory and the real-world application of fire curves still continues today and has led to attempts to give the natural fire curve a more specific position as a scientific model in recent years. The box below provides illustrative information about fire curves and their connection with developments in this sub-field



of fire safety. This information has been derived from recent studies by the Netherlands Institute for Safety (NIFV).

## 2.2 Fire load

In addition to fire resistance, the concept of 'fire load', which had already been introduced in the UK, was also used in the Netherlands as a scientific

### Fire curve

In recent years, there has been an increasing demand for a new model for fire development. The NIFV is now researching a new model. The models used in the Netherlands can be divided into four main categories:

- a. the standard fire curve and other NEN fire curves
- b. natural fire curves
- c. the normative fire development
- d. other models.

Most models address temperature development relative to time and some models are based on heat radiation relative to time. The odd model deals with smoke development relative to time. The models are applied in order to set preventative and repressive requirements and to enable safe repressive action. Fire safety engineering also employs classification into rated fire curves, parametric fire curves, single-zone models, multi-zone models and field models.

In the Netherlands, the need for model-based understanding of the following aspects of fire development has arisen:

- Development of temperature relative to time for a smouldering fire and for a fully developed fire.
- Decrease in temperature after the highest temperature has been reached.
- Development of heat radiation relative to time for a smouldering fire and for a fully developed fire.
- Decrease in heat radiation after the highest heat radiation has been reached.
- Development of decrease of visibility (smoke density) relative to time.
- Smoke spread relative to time.
- Development of toxicity relative to time.
- Differentiation into types of fire.
- Differentiation into variables in the room.

The commonly used models partially fulfil this need for knowledge. Every model provides a small part of the total need for knowledge. There is no single integrated model that goes into all the relevant aspects of fire. For example, no model goes into the toxicity of smoke. Every model provides a simplified description of a small part of a large and complex reality. But as long as users recognise this, the use of models should not be a problem at all. A simplified representation of reality may sometimes be very valuable. However, things might become problematic if models are used for objectives for which they were not originally intended and for which they are not suitable. An important and current example of such improper use is the substantiation of standards for the fire service response times.

One of the conclusions of the first part of the study is that fire is a highly complex process and that the fire models that have been studied address only a very limited part of this complex process. Most models address the temperature development relative to the time of an average fire in an average room under average conditions. The current focus on temperature

development in the event of a fire has been found not to be a good standard for people's safety, certainly if it is considered as the only standard. That is why work should be done to come up with a different model that considers more risks of a fire than only the temperature development. The development of smoke, for example, might be a part of this.

During the study it was found that there is a great deal of misunderstanding as to the limited applicability of the fire curve in many areas. A striking example of this is the improper use of a fire curve, starting from the temperature development, in the discussion on response times. Apparently there is a large-scale lack of sufficient knowledge of the model-based approach to fire development and the practical usefulness of that approach in the Netherlands. A model-based fire approach may provide an important contribution to our understanding of how a fire can develop in a certain situation and what this means for the chances of survival of any people that are still present. This may be very important for establishing the most effective fire prevention measures and for deciding on the most efficient and safest tactics to fight a fire.

Relatively little is known about how smoke develops and its harmful effects. Scientific literature is not unanimous in this regard. Before developing a model that can also assess the harmful effects of smoke, more studies will have to be conducted into the harmful effects of smoke and smoke production related to time and related to heat development. More advanced fire models can be used to set preventative and repressive requirements and to promote safe repressive action. Standards for the response times that are based on better substantiation can then be achieved as well. The development of the cascade model (see chapter 2) is the first step towards a new model for fire development.

foundation of the fire risk of a building in the period after the Second World War. After the war, large-scale systematic studies had been conducted in the UK in order to assess the extent to which the amount, nature and spread of the combustible materials present could lead to a better understanding of how to protect buildings against fire. The application of the concept of fire load and the relationship found between the fire load and the fire duration made it clear that, in general, no more stringent requirements need to be imposed on the fire resistance of construction parts than those that follow from the fire load. This led the Netherlands to part with the American method of determining fire resistance, in which the relationship between the fire load, fire duration and fire resistance was less clear and which resulted in a fire resistance requirement of 1.5 times higher than that calculated using the English method. The English method was not free from criticism either. The fires studied in the UK were wartime fires. As stated, experts considered the fire load in buildings to be completely different in wartime than it was in times of peace but this fact was ignored.



High fire load

However, this evidence base did not always result in the much desired easing of fire safety requirements in the Netherlands. Economically attractive structures were increasingly introduced in those days as well. As the evidence base for fire resistance requirements of structures, based on fire load, excluded certain structures or necessitated additional, and costly, facilities, it is logical that architects and structural engineers in particular would look for arguments to contest the general basis for the fire load. They used a system developed in Germany for this. This system consisted of 50 points for construction, use and location of the building, fire alerting and possibilities of firefighting that should lead to easing the fire resistance requirements. But since all these points lacked empirical validation they could not be maintained for long.

### 2.3 Compartmentation

In the following period, from 1950 to 1980, criticism of the lack of evidence base for the main fire prevention aspects, i.e. fire resistance and fire load, fell silent. Fire safety requirements were increasingly laid down in municipal schemes and publications based on assumptions and agreements that had been the subject of heated debate in the preceding years.

Dividing buildings into fire compartments was also a new development in the period just after the Second World War. This made an appearance because the standardised time/temperature curve (the standard fire curve) could not be applied to buildings with a high fire load. The advice for



buildings where a lot of combustible material was stored, was to distribute the material over several rooms or to install fire-resistant partitions in order to divide a large room into several smaller rooms. If such a division was not possible for technical business reasons, a sprinkler system was considered to be the only proper facility. What is remarkable is that even at that time, the conclusion had been reached that the technical requirements set on sprinkler systems should be lowered in order not to impede the wide application of sprinkler systems. It was also in this period that insurance companies defined their requirements and government bodies argued that these requirements were too strict from the point of view of public fire safety.

In the early 1970s, a Dutch publication entitled '*Brandbeveiliging Industrieterrainen*' (Fire Protection of Industrial Estates) provided a norm for the size of fire compartments based on the criterion that buildings, and specifically industrial buildings had to be properly accessible for the fire service. This norm was substantiated by the fact that the dimensions of business premises determine how effective intervention is in the event of a fire, especially in those situations where the fire service is no longer able to fight the fire from within. That is why the throw length of a jet of water, which had been defined at 25 metres, became the standard unit to determine the maximum compartment size. For example, the depth of premises from each accessible side could only be 25 metres. That meant that a building that could be accessed on four sides could be a maximum of 50 x 50 metres. This defined the size of 2500 m<sup>2</sup>, which is still being used, although it was not defined scientifically.

In later years, the scientific embedding of fire prevention did not progress much beyond the reaction of building materials and building structures to fire. The standard fire curve was particularly cherished by TNO. In those days, this Dutch research organisation was very influential as regards fire safety and a standardised method that enabled fire tests to be conducted served its interests well. Discussions about another model were not welcome here.

## 2.4 Structural safety

In the mid-twentieth century, attention shifted to the requirements that should be imposed on building structures since “in order to enable efficient firefighting, the fire service will, as a rule, have to enter the burning building in order to save any victims, to attempt to put out the fire and to prevent the fire from spreading.”

The conclusion was that, if a building consists of one layer or 'storey', the fire service cannot be on any other storeys. This implied that, from the safety perspective, it was actually not necessary to impose special requirements on the fire resistance of the load-bearing structure since if the load-bearing structures were exposed to a temperature that was

so high that they might fail, this temperature would also be too high to enable firefighters to take action. Where firefighters could take action, the temperature would be so low (40 to 45 °C) that, as demonstrated in real-world situations, there was no risk of the structure collapsing.

It was argued that in all other cases, the risk of a burning multi-storey building partially collapsing and threatening the safety of the fire service personnel in the building had to be taken into consideration and facilities to prevent this would have to be taken. If requirements were nonetheless to be imposed on the fire resistance of the construction of a one-storey building, that could only be done on the grounds of the fire spreading to adjoining buildings.

This principle, which dates back more than 50 years, still applies today, but in those days it was inspired by the impossibility for firefighters to enter burning compartments since they did not have protective clothing and breathing equipment at their disposal. As this protective equipment steadily improved from the 1970s on and the fire service was able to get further and further into burning compartments, no requirements were imposed on the fire resistance of the construction either. After the dangers of backdraft and fire gas explosions and other dangers that were unknown in those days became known in the last few decades, the fire service is now strongly refocusing on the alleged logic of indoor attacks.

Market players are involving the damage limitation role of the fire service and the government in this change of focus. Transparency about this had also already been achieved more than half a century ago. The opinion that prevailed in those days is no different from today. “The question of how far the government should concern itself -by drawing up instructions- with interests that first and foremost concern the owners and occupants of buildings has to be posed. In general, in this respect, these stakeholders will have to decide for themselves which architectural or other safety facilities they wish to implement. No doubt they will be influenced by the interaction between possible non-life and fire insurance premiums, whereas nothing stops them from seeking advice from the government (the local building control department or the fire service) if they find this necessary to further lower their risk.”

## 2.5 Safe evacuation

The first rules to enable safe evacuation came into being in the USA in the first half of the last century. These rules were based on the number of escape routes and their capacity. After the war, the first requirements for safe evacuation were also introduced in the UK. Other than in the USA, they were mainly based on the use of non-combustible materials or materials with slow fire propagation. The number of people was not the main starting point for evacuation requirements. There were substantial differences in evacuation time and the necessary egress width between the USA and the UK (they differed by a factor 2 to 3).



Safe evacuation

Although post-war Dutch legislation regarding fire prevention - the Safety Act (*Veiligheidswet*), the Housing Act (*Woningwet*), the Nuisance Act (*Hinderwet*) and the Plumbers Act (*Loodgieterswet*) - did not contain any instructions on safe evacuation, interest in safe evacuation grew in the years after the war. For instance, it was argued that “the requirements set on escape routes are more important than the requirements set on a good fire service organisation.” That is why most municipal building regulations had already given the municipal executive the authority to adopt further regulations on safe evacuation from non-residential buildings. There was no uniform opinion as to the requirements that should be imposed. Other countries, such as Germany, France, the UK and the USA, had already conducted tests and observations before the war, which formed the basis for developing



guidelines. However, as has been said, these guidelines greatly differed from each other. For example, the Amsterdam fire brigade employed an egress width of 90 cm for every 100 occupants. In France and Germany this was 125 occupants. The USA and the UK worked with a unit of egress width. This was 22 inches, approximately 56 cm. France also adopted a unit of egress width, which was defined at 60 cm, based on tests performed at the Printemps department store.

Some countries used the combustible contents of buildings, i.e. the fire load, as the determining factor for evacuation requirements. This led to hospitals, for example, being classified as buildings with a low safety risk for people in the event of a fire. In the Netherlands, there was immediately an uncomfortable feeling about these requirements and the substantiation based on fire load, especially in view of the major differences between the American and British rules and the absence of a scientific basis for determining evacuation times. There was a feeling in the Netherlands that evacuation time depends on more aspects and the methods employed there were based on such assumptions as: “The evacuation time for buildings where the presence of a large number of people implies that the risk of panic must be taken into serious consideration must be shorter than for buildings where conditions are expedient for quick evacuation.”

In the Netherlands, there was a growing impression that there was insufficient knowledge of the factors that affect evacuation possibilities and that this lack of knowledge was often the reason why “not entirely sound requirements are set” in other countries. The conclusion that was drawn in the Netherlands was that the calculations for exits, stairs and other escape routes had to make way for more scientifically sound calculation methods. Pleas were made for further studies and lots of testing that would come as close as possible to the real-life situation. However, things never got this far. The system of unit of egress widths was introduced though, with a size of 55 cm.

In 1984, the Stichting Bouwresearch knowledge platform published a paper entitled ‘*Menselijk gedrag bij brand*’ (People’s behaviour in the event of a fire) because “the study of human behaviour in the event of fire is of extreme importance in the total field of research into fire and fire safety”. However, this publication stated that experimental research into people’s behaviour in the event of a fire is impossible due to the risks involved and that evacuation drills do not provide any representative information. As a result, the report was based on a lot of theoretical research from other countries, which in turn was based on interviews with survivors, discussions with psychologists and the results of post-mortem examinations on fire casualties. Recommendations about discovering fire and alerting the people involved as well as the quality and capacity of escape routes were made on the basis of all these studies.

But the overall conclusion is that people's reaction to fire is still a minor aspect in statutory fire safety schemes. This has been demonstrated by recent Dutch PhD research, performed by the Netherlands Institute for Safety. The obligatory green emergency exit signs are a good example of this. In practice, people fleeing from a building ignore them or cannot see them due to the smoke. However, this continues to be a strict requirement in the relevant regulations.

## 2.6 General assumptions for determining fire resistance values

As indicated in chapters 2 and 6, the Dutch Building Decree employs some general assumptions that are necessary for being able to determine the fire resistance values of structures, partitions and escape routes:

- The fire must be discovered, and the people endangered by the fire, as well as the fire service, must be alerted within 15 minutes of the fire starting.
- The people endangered by a fire must be able to flee without the fire service's assistance within 15 minutes of having been alerted.
- The fire service is present and operational within 15 minutes of the fire being reported.
- The fire service must have the fire under control within 60 minutes of the fire starting, which implies that the fire must be prevented from spreading further. At such time, the last people endangered by the fire must have been rescued with the fire service's assistance.

The fact that this timing was already used in the first half of the previous century to a certain extent demonstrates that these assumptions have no evidence base. At the time, it was indicated that “in places with a properly equipped fire service it can be assumed that the offensive will have started no later than 15 minutes after the fire has been reported. In such an event, the door to an escape route must be constructed such that it will stop the fire for 15 minutes”. The time needed for discovering the fire was not taken into account.

After the war, the understanding grew that the discovery time of fire also had to be considered in order to determine the fire resistance of escape routes and other building parts. “The fire resistance of those construction elements that restrict the escape route must be modified appropriately. This means that, in general, this fire resistance will not be determined by the fire load of the adjoining rooms, but by the maximum time between the inception of the fire and the evacuation of the building. In other words, this time is determined by the sum of the time that expires between the inception of the fire and its being discovered.” This was written in the late 1950s. However, the question was what time should be applied to the discovery of the fire, since these discovery times were found to differ greatly in practice.

To be able to determine a standard (time) it was decided that the moment of flashover, based on a temperature of 750 °C, should be taken as the criterion for the absolute maximum moment of a fire being discovered.

The standard fire curve showed that this temperature is reached after 15 minutes. After determining a response and attack time, the discovery time had now also been determined. The result was that escape routes must have a fire resistance of 30 minutes, which is still one of the basic assumptions in Dutch building regulations. A new fire curve will probably change this.

The basic assumption that the fire service must have the fire under control within 60 minutes of its inception, implying that the fire resistance of structures must be maintained for a total of 60 minutes, also stems from the 1950s, but it was based on a slightly different line of reasoning. Its motivation was as follows: “Experience has shown that fighting a fire inside a building does not always enable a positive result to be achieved and the fire service has to completely or partly withdraw from the building to enable the fire to be completely or partly fought from the outside. It can usually be established some 30 minutes after firefighting has started whether this latter aspect is necessary. This means that, for the fire service's safety, the fire resistance standard can be set at 1 hour (30 + 30 minutes) as regards the load-bearing structure parts of the building.”

### 3. New impetuses

In the early twenty-first century, people started calling for a different approach, one that was not only based on the rules, but that also considered the risks. In other countries, especially in the Anglo-Saxon countries and Scandinavia, this approach, referred to as a 'performance-based assessment system', had already brought good results, especially as regards the effectiveness and efficiency of fire prevention measures and facilities. This new assessment system is based on fire safety science, a science with a number of instruments that had not been applied in the Netherlands so far. Calculation software, enabling fire development, smoke spread and escape behaviour to be calculated, was introduced. Many of these software tools had originally been developed for other scientific fields, but they were found to be suitable, often after having been modified, for use in fire safety applications.

This new form of applying fire prevention was called fire safety engineering (FSE). FSE is a risk-based approach for implementing fire prevention. Conceptual thinking about fire safety is the main pillar in this. FSE has introduced knowledge about reactions to fire and about people's behaviour, which has recently been expanded by knowledge about interventions, into building design and risk analyses. This knowledge has resulted from fundamental and applied scientific research. A major step towards evidence-

based fire prevention has thus been taken. However, even in a performance-based approach there are fixed reference values. As concluded above, these reference values, as laid down in building regulations, are hardly the result of scientific research, but tend to be based on assumptions and agreements. This is still the major gap in evidence-based fire prevention.

Another gap is now slowly being filled: the lack of knowledge obtained from actual fires. Some years ago, the Dutch fire service started conducting fire studies structurally and traceably to record case histories and useful statistical information. For example, structural statistical research has been conducted into all fatal fires in people's homes since 2008.



## **Chapter 8**

### **Fire and fire development**





## Introduction

This chapter addresses the inception of a fire, its development and the spread of smoke. The details of this chapter are limited to the aspects that are of direct importance for the relationships between fire and fire prevention. Fire prevention concerns preventing fire, minimising fire growth and reducing smoke spread.

### 1. The inception of fire

As a fire is the result of combustible material, oxygen and ignition temperature being combined, there is always a risk of fire since buildings contain sufficient combustible material and oxygen. This is confirmed in the real-world situation.

Fire gives off heat. The total heat that can be released by a burning substance is referred to as the specific latent heat. This energy is measured in J/kg. The total heat released when wood is completely burnt is between 17 and 20 MJ/kg. There are major differences in the specific latent heat produced by different kinds of plastic. Some plastics hardly generate any heat, whereas the latent heat of others can be compared to that of fuel oil, i.e. between 40 and 50 MJ/kg.

The type of fuel determines how much energy is initially required to initiate combustion. For example, combustible gases usually require only a slight source of ignition to cause a combustion reaction with oxygen. Solids like wood first have to form combustible gases before they can start burning. The spread of the fuel throughout the room determines how the fire will develop further. Porous and wooden materials in furniture contribute to fast fire development. Plastics sometimes cause a fire to spread fast: they start dripping and thus lead to fire on the floor.

The speed of the flame spread is governed to a considerable degree by the types of substances that are mixed together. The position of fuels relative to the initial fire is of great influence as well. For example, flames spread much faster along a vertical surface than along a horizontal surface.

Once a fire has started, it will continue as long as the right amounts and ratio of fuel and oxygen are present and the temperature remains sufficiently high. If no human intervention follows, the temperature in the burning room will become ever higher as heat is released in the combustion process. This results in:

- more materials releasing gases
- more gases igniting
- the flame front increasing in size
- heat radiation increasing and accelerating the fire development.



As the energy released in a fire heats up the other combustible materials in the room they will also release combustible gases. The latent fuel present in materials such as furniture, wallpaper, etc. is released in the form of gas and made suitable for a combustion reaction. The gases ignite when their ignition temperature is reached. The fire heats itself as it were and can thus maintain itself and spread. This continues until so much oxygen or fuel has burnt that too little of one of them is available; the right ratio then no longer exists. The fire slowly dies out.

## 2. Combustion products

When a material burns, its combustible substances assume a gaseous state and react with oxygen, converting the material into combustion products. This reaction with oxygen causes the combustible substance carbon, the main element of combustible material, to be converted into the combustion product carbon dioxide or carbon monoxide. The increase in temperature during the combustion process causes the combustion products to expand and rise into the air. The combustible products found in smoke and fire gases are the result of the pyrolysis (decomposition) of substances that do not come into contact with the actual seat of the fire or of incomplete combustion of the seat of the fire. Since the temperature is often high at ceiling level, combustible ceiling material will often release gases.

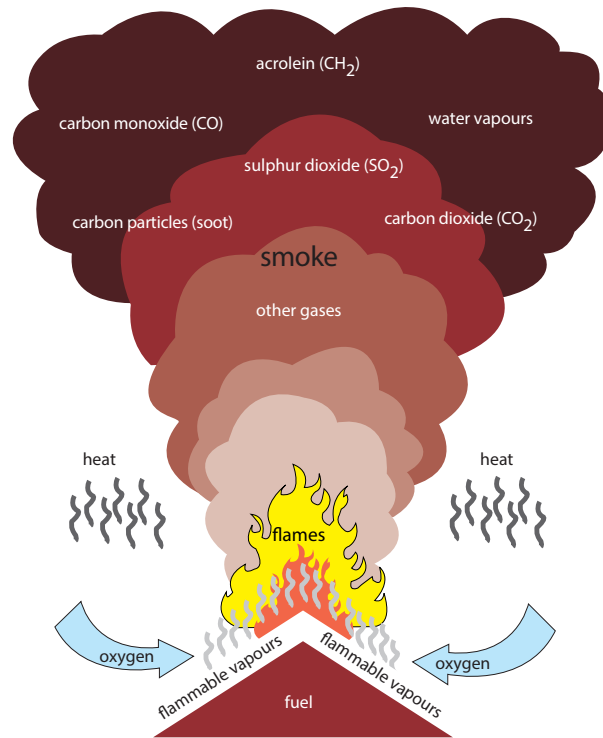
The following combustion products develop when a material burns:

- Flames; the visible appearance of burning gases.
- Energy; the molecules in the burning material become more active during the combustion process producing a lot of thermal energy. The temperature is an indication of the amount of energy that is released. High temperatures are also referred to as heat.
- Smoke; the aggregate of fire gases and unburnt carbon particles (soot).

The composition of the air changes drastically during the combustion process. The oxygen content decreases because the air expands (as the air is heated its volume increases) and oxygen is converted into carbon dioxide (the result of the combustion reaction).

However, there is a continuous increase in the content of combustion products in the air, such as:

- carbon
- carbon dioxide (CO<sub>2</sub>)
- carbon monoxide (CO)
- water vapour
- other gases and vapours.



**Figure 69** Combustion products

Large quantities of carbon monoxide will be produced if the room has a wooden ceiling. This may lead to a carbon monoxide content of 10-15%. The amount of carbon monoxide in the air may vary from 0% to 15%, depending on the composition of the fuel. The percentage of carbon monoxide becomes critical at 1500 ppm, which equals a volume of 0.15%. Hydrochloric acid is formed during the pyrolysis of certain cable insulation materials, such as PVC. Hydrochloric acid is a colourless and highly corrosive gas. Inhalation may be fatal. This may occur if the gas has accumulated in a room from which people are unable to leave.

Combustion products may be harmful; the same goes for a decrease in the oxygen content in the air. Furthermore, a lack of oxygen frustrates breathing and adversely affects vital bodily functions. A shortage of oxygen during a fire slows down the combustion process; the fire will change into a smouldering fire. A smouldering fire is characterised by incomplete combustion, resulting in more smoke that contains more unburnt combustible gases. Besides this, the temperature of the fire gases and the oxygen endangers people, since their bronchial tubes will already be affected at a relatively low temperature.

### 3. Fire spread in the room

A fire in a closed room goes through three stages:

- a growth stage
- a fully developed stage
- a smouldering stage.

Every stage has its own specific temperature range. The fire curve shows the relationships between temperature and time for a fire in a closed room. As this is a model, it is a simplification of the real situation.

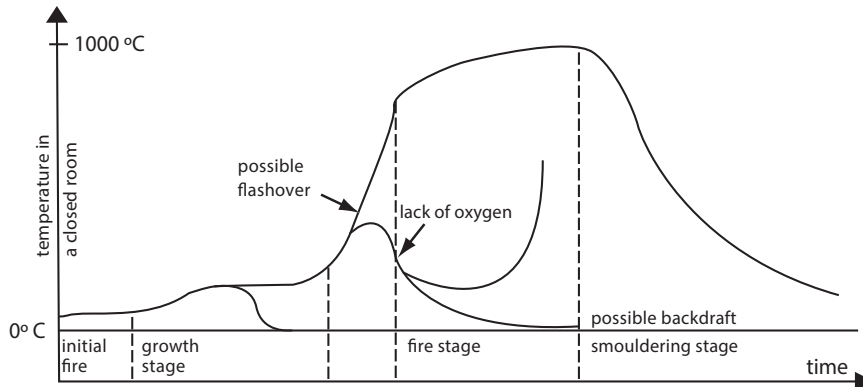


Figure 70 Fire curve

#### 3.1 Growth stage

The growth period starts with an incipient fire. This is the stage where the fire slowly grows, e.g. due to a burning candle on a sofa, setting fire to the seat of the sofa. The burning upholstery of the sofa is then the start of the fire in the room.



Figure 71 Growth stage of a fire in a room

The combustibility of solids is determined on the basis of the time that elapses until the material ignites. The thermal inertia of a material is an indication of the speeds at which it heats up and cools down. Thermal inertia is expressed as  $k\rho c$ . The surface of a material with a low  $k\rho c$  heats up fast, whereas a material with a high  $k\rho c$  heats up slowly. An incipient fire raises the temperature in the room causing other fuels to start to decompose. This pyrolysis starts immediately upon the inception of the fire and intensifies as the temperature rises. Fire gases are released as part of the pyrolysis process.

These fire gases are much lighter than air and rise up into the air, creating a very hot gas cloud at the ceiling. The heat is stored in the carbon particles of the smoke layer. The hot gas cloud radiates heat to other objects in the room, causing them to decompose. This creates even more fire gases that rise up, making the gas cloud even hotter, more combustible and more concentrated. At a temperature between  $200\text{ }^{\circ}\text{C}$  and  $300\text{ }^{\circ}\text{C}$  so many combustible gases will have collected that a combustible gas/air mixture may occur. The fire may progress from this stage, depending on various factors. The availability of sufficient oxygen is an important factor. There are situations where a fire goes out during its growth phase. There will be a lot of smoke in the room then, but no fire. This may be due to a shortage of oxygen or it may be due to the fact that the incipient fire had insufficient 'energy content' to cause the adjacent combustible substances to decompose (releasing combustible gases).

Figure 72 shows a gas cloud against the ceiling. This was caused by a sofa on fire, the incipient fire. Besides this, gases are being released from various items of furniture as a result of the heat radiated from the cloud to all objects in the room. The room is slowly filled with fire gases. This is a typical characteristic of the growth stage.



**Figure 72** Growth stage of a fire

### 3.2 Fully developed stage

During the fully developed stage, the combustion process can be divided into fire with flames and smouldering. Fire with flames, or 'homogeneous oxidation', occurs when the fuel and the oxidation agent are in the same state, e.g. two gases. Smouldering, or heterogeneous oxidation, takes place at the surface when the fuel and the oxidation agent are not in the same state, e.g. if the fuel is a solid and the oxidant is a gas. Smouldering may occur at the surface or inside porous materials, as long as there is access to oxygen to enable oxidation to continue. The heat can even stay inside the material and can support pyrolysis until auto-ignition possibly takes place.

The layer of solid carbon on scorched remnants is a porous, usually smouldering substance. A smouldering fire often produces lots of pyrolysis products not all of which oxidise at the same time. In the event of a fire in a closed room, the pyrolysis products are emitted by the burning object and collect in the upper part of the room without having burnt up. The room then gradually fills with smoke and fire gases that mainly consist of carbon monoxide (toxic if inhaled). As a result, smouldering fires can lead to fatalities.

The fire curve contains a part between the growth stage and the fully developed stage in which the temperature rises quickly. The name of fully developed stage speaks for itself. If flashover occurs, the temperature goes up very fast. The room is suddenly completely on fire due to gases and vapours igniting. This leads to a short-term maximum flame front size. In that same period, there is also maximum heat radiation and release of gas from materials. If no flashover occurs, the temperature may rise more slowly. But even then, the temperature in the fully developed stage will rise to approx. 900 °C within 15 minutes. All combustible materials will burn up and combustible gases will ignite fast.

### 3.3 Smouldering stage

The combustion process slows down when almost all of the oxygen in the room has burnt up, and the temperature in the room will drop. The fully developed stage then turns into the smouldering stage. The remaining combustible material in the nearly closed room may be red-hot in this stage of the fire, but the flames will have already been extinguished due to a lack of oxygen. This causes the temperature to decrease. However, the temperature is still sufficiently high and there are still enough combustible gases to nevertheless cause backdraft if only the slightest amount of oxygen is supplied. The materials also continue to release gases due to the high temperature in the room.



Fire that is no longer contained inside the building

### 3.4 Characteristics of fire development in a closed room

The following aspects are important for fire development in a closed room.

Pyrolysis continues all the time. As heat can hardly escape from a closed room, the materials get warmer and warmer and continue to release gases. This means that if there is a fire in a closed room, an accumulation of combustible gases, especially right below the ceiling and in hidden compartments as in modular ceilings, will always have to be reckoned with.

The fuel/oxygen ratio varies. A fire can suddenly flare up, as is the case in its growth stage, but it can also go out quickly again, as it does in its smouldering phase. This is because the fuel/oxygen ratio varies as the fire develops. During the growth phase there is still a lot of oxygen, causing the fire to spread immediately as soon as the combustible substances have reached their ignition temperatures. This is called 'fuel-controlled'. A flashover is an extreme form of this sudden fire spread. Later, during the smouldering stage, there is not enough oxygen left to fully burn the remaining fuel. However, since there are still plenty of combustible gases in the room and the release of gases continues during the smouldering stage, the slightest amount of air entering the room is sufficient to cause the fire to flare up again. This is called 'ventilation-controlled' or 'oxygen-controlled'. A backdraft occurs if this happens in an explosive manner. Flammable and combustible gases may form within a confined building, either in the room with the fire or in adjoining rooms. They may also travel away from the seat of the fire, to another place in the building or on the roof. These gases may ignite without air being supplied. They have already

formed an ideal mixture and are waiting for any source of ignition. The explosion that follows can be compared to a backdraft, but it would be more accurate to refer to it as a fire gas explosion or fire gases igniting. Backdraft and flashover can be recognised by certain signs; a fire gas explosion cannot.

## 4. Further fire spread

The speed of flame spread increases along with the rise in ambient temperature. The surface gets hotter and the ignition temperature is reached faster. The higher the initial temperature, the faster the flames will spread. Another consequence is that the higher the initial temperature of a substance, the sooner its surface will produce enough combustible gases.

The surface temperature of solids must be between 300 °C and 400 °C for ignition by a flame. If no flames are near, the surface has to reach a temperature of between 500 °C and 600 °C. The combustibility of solids is determined by measuring the time that elapses until ignition. The lower the kpc value of a substance, the shorter its ignition time. This means that porous wood fibre board ignites faster than particle board.

Flames will spread rather slowly on the surface of a material with high thermal inertia, which is usually a high-density material. This means that flames will usually spread more slowly over a heavy material than a light material. The orientation of the surface and direction of the flames also influence the speed of the flame spread. Vertical flame spread in an upward direction mainly causes a fire to spread fast. Flame spread along the ceiling of a closed room may also lead to fast fire growth. There are two reasons for this: firstly, the air flow forces the flames forwards and secondly the ceiling's surface has heated up considerably due to the hot smoke and fire gases that have collected at the ceiling. Horizontal flame spread in a downward direction along the lower part of the wall in a closed room takes place much more slowly. In certain situations, when flashover is about to occur, flames can travel downwards very fast because radiation has heated the surface.

Both flame spread of solids and flame spread in layers of smoke and fire gases are crucial for fire spread. Flame spread along the lower side of a layer of smoke or fire gases is a common sign that something is changing in the room with the fire. This type of flame spread is an important signal for firefighters with respiratory devices who have to fight the fire. In the event of upward vertical flame spread, many substances, such as wood fibre board and particle board, will produce flames that are about twice as high, during the same period of time.

### 4.1 Heat transport

Heat is a form of energy that can be measured by a thermometer. Heat transport is the transfer of energy from one material to another. This transfer is always one-way traffic, i.e. from a material with a high temperature to a material with a lower temperature. Heat always travels from hot to cold.

Heat transport may take place through conduction, radiation and convection. Conduction refers to the transfer of heat through a solid medium that does not move. Radiation is the transfer of heat energy across a space without a medium. Convection is when heat is transferred by the movement of a medium. Updraught is a special form of convection. The above description shows that updraught occurs in all rooms where there is a fire. Updraught refers to hot air or smoke rising through several storeys, e.g. in a stairwell or atrium. In addition to updraught, the temperature difference also causes pressure differences in a closed room. Overpressure occurs in the upper part of the room where the air pressure is higher than the atmospheric air pressure, whereas underpressure occurs in the lower part of the room where the air pressure is lower than the atmospheric air pressure. There is an area with neutral pressure between the areas of overpressure and underpressure, where the air pressure is more or less equal to the atmospheric air pressure. Repressive ventilation makes use of these pressure differences. Since the fire gases can be discharged to the outside air the fastest at the point where the pressure of the layer of fire gases is the highest, the outlet opening with repressive ventilation is usually placed at the highest possible point in the room with the fire.





## **Annex A**

### **Building profiles**





## Introduction

Chapters 4 and 5 link the risks based on the most influential risk factors to the buildings in groups 1 - 4:

- office buildings (group 1: people who are able to leave without assistance)
- educational buildings (group 1: people who are able to leave without assistance)
- public buildings (group 1: people who are able to leave without assistance)
- industrial buildings (group 1: people who are able to leave without assistance)
- guest accommodation buildings (group 2: people who can leave without assistance and who sleep in the building)
- healthcare buildings (group 3: people who cannot leave without assistance and who sleep in the building)
- cells and buildings that house cells (group 3: people who cannot leave without assistance and who sleep in the building)
- residential buildings and dwellings (group 4: people who can leave without assistance and who sleep in the building)

This is quite a rough classification that is based on the series of fire protection concepts drawn up by the former Dutch Ministry of the Interior (published 1994-1996). The number of building types listed is limited. In practice, however, there will be much more diversity within one and the same group and the risk profiles of buildings within one and the same group may differ. This annex gives an impression of this diversity by sketching the profiles of the various types of building in order to enable the users of this document to assess the risks of a particular building.

Due to the wide variety of buildings, structural characteristics such as building volumes and building heights will not be considered here. We have started from the assumption that buildings come in all sorts and types, shapes and sizes. The profiles sketch the nature or 'purpose' of the buildings, their occupancy, population and specific areas of attention. These profiles are not intended to be restrictive; they only serve to give an impression. Please be aware that, in practice, a building will often serve several purposes. One group 1 type of building that is hard to classify is the type of building for parking/housing vehicles. To do justice to this purpose, it has been given its own individual profile description.

## Group 1: Office buildings, educational buildings, public buildings and industrial buildings

### Office buildings

#### *Characteristics*

Office buildings are mainly organised such that administrative work can be performed in them. Examples are buildings and parts of buildings for banks, utility companies, insurance companies, law firms, trading companies, courts of law and town halls.

#### *Occupancy*

These buildings tend to be only occupied in the daytime. There may be a small number of people present in these buildings outside office hours, e.g. cleaners, people who are working overtime and security guards. There are no major internal movements of people, except at the start and the end of the working day.

#### *Population*

In general, occupants of an office building are aged between 18 and 65. The occupants are awake, are familiar with the layout of the building, and the majority of them are able-bodied (i.e. able to leave without assistance) and have normal intellectual capacities. The number of visitors is limited.

It is assumed that any visitors and less able-bodied people present who would not be able to leave without assistance will be helped by others to reach a safe place in the event of a fire. There will only be few people who cannot leave without assistance.

#### *Areas requiring special attention*

Since a relatively large proportion of office space is let, large office buildings typically house multiple tenants. This may result in security measures being implemented that negatively affect safety, i.e. the ability to escape from the building.

### Educational buildings

#### *Characteristics*

Educational buildings are set up for providing various types of schooling such as:

- primary education (elementary education, special needs education and secondary special needs education)
- secondary education (general secondary education and pre-university education)
- vocational education and education for adults
- higher vocational education
- academic education.

### *Nurseries/Day-care centres*

There are also buildings that are designated as nurseries or day-care centres for children. This is a special category in view of escape safety requirements. The children in these buildings are mainly aged up to four years old and are considered to be unable to leave without assistance. This category includes commercial day-care with sleeping facilities, pre-school, after-school and 24-hour care facilities.

### **Occupancy**

The different types of education tend to have different opening hours. Primary schools are open on working days from about 8 a.m. to 5 p.m. If these buildings are used in the evenings, this may be because they have been let to third parties. Such use is not always for educational purposes. The other types of educational buildings are more often open in the evening for educational purposes, e.g. adult education. Educational buildings may also be used at night sometimes. These will usually be research institutions for higher vocational education and universities where experiments are done. The category of nurseries and day-care centres has different opening hours.

The lessons or teaching sessions may be either theoretical or practical. Certain actions during practical lessons may entail fire risks, such as physics or chemistry tests in science labs where open flames are used. Pupils in primary education tend to stay in their own designated classrooms. These are often located on the ground floor with a door that leads directly outside. These pupils may also make use of a gymnastics room or a multi-purpose room. The occupants of buildings used for other types of education usually move between rooms for different classes.

### **Population**

The occupants' age is directly related to their ability to escape from the building themselves. Most children aged six or younger are unable to leave a building themselves. They will also find it difficult to go downstairs fast. In multi-storey, elementary school buildings, this age group is usually housed on the ground floor. Occupants of an educational building aged six or older are considered to be able to leave a building in time and on their own when supervised by a teacher. Apart from child care buildings, it is assumed that the occupants are awake, are familiar with the layout of the building, that the majority of them are able-bodied, i.e. able to leave without assistance, and that they have normal intellectual capacities. Furthermore, it is assumed that any visitors and less able-bodied people present, who would not be able to leave without assistance will be helped by other people to reach a safe place in the event of a fire. In general, the number of people who cannot leave without assistance will be low, except maybe in special needs education.

### **Areas requiring special attention**

The circulation areas in educational buildings, such as hallways, are also used for other purposes, e.g. for playing, providing information or studying. On a final note, the child care category requires specific attention because this population is unable to leave without assistance.

## Public buildings

### Characteristics

Public buildings are buildings which, due to their construction and physical arrangement, are intended for providing food and drinks on a commercial basis and for their consumption on site, for culture and sports, for the arrival and departure of public services and amenities (road, railway, water or air traffic) and for trading materials, goods and services. Based on their occupancy, these buildings can be divided into the following main groups:

- venue buildings
- buildings housing bars and/or restaurants
- sports buildings
- station buildings
- shop buildings.

The distinction between the buildings is not always easy to make. For example, a discotheque has both a venue purpose and a catering purpose, and a major sports event may combine venue and sports purposes. Since the risks as regards fire have to be assessed on the basis of people who are able to leave without assistance, there are generally similarities between the groups in terms of escape safety.

However, given the great diversity, there will always be differences in risk profiles. The public buildings have been listed in figure 1.

This listing is not intended to be exhaustive; it only serves to give an impression.

<b>Venue buildings</b>	<b>Sports buildings</b>
auditorium	ballet studio
cinema	fitness centre
community centre	gym
church	covered sports stadium
museum	sports hall
meeting centre	swimming pool
exhibition hall	
theatre	<b>Station buildings</b>
play accommodation (children)	covered station (railway, underground and bus)
	airport building
<b>Buildings housing bars and/or restaurants</b>	port building
company/sports canteen	
pub	<b>Shop buildings</b>
discotheque	building materials store
dining room/mess	department store
restaurant	shop/shopping centre
	garden centre
	home furnishing shop

Figure 1 Subdivision of public buildings

### **Occupancy**

The use of public buildings matches the purpose of the building. Some of these buildings have a rather singular purpose, such as shops, museums, sports buildings, pubs and restaurants. Others have multiple purposes, e.g. exhibition halls, theatres, churches, meeting centres and some sports buildings. Multiple use is often a necessity from a commercial operations perspective. The time when public buildings are open to the public depends on the purpose of the building and its occupancy. These buildings may be occupied in the daytime, in the evening and/or at night.

### **Population**

The number of occupants of public buildings and their ages may vary greatly. In buildings where different kinds of events are hosted, the actual type of occupants depends on the target group for the event being hosted. Young children (of up to about six years old) will usually not leave a building without help. It has been assumed that the occupants are awake, that the majority of them are able-bodied, i.e. able to leave without assistance, and that they have normal intellectual capacities. They will usually not be familiar with the layout of the building. Furthermore, it is assumed that any less able-bodied people present who would not be able to leave without assistance will be helped by other people to reach a safe place in the event of a fire. Only a small number of people will not be able to leave without assistance.

### **Areas requiring special attention**

It should be noted that excessive alcohol or drug consumption may cause irrational and aggressive behaviour that will negatively affect escape safety. A relatively large number of temporary staff tend to be employed in public buildings. These people are often not, or insufficiently, familiar with the layout of the building and the safety procedures in force. Depending on the purpose, large numbers of visitors should be taken into account. If rooms are used for multiple purposes or by different groups, account must be taken of different flows of people. Once a crowd has started to move it must not be slowed down too much, as this might result in panic, leading to casualties as people may be trampled underfoot. Large flows of people involve risks due to traffic routes becoming obstructed, people being crushed or becoming frightened of being crushed and panicking. If play facilities for children are present, the escape safety requirements of the play structures, such as mazes/climbing structures, must be taken into account.

## **Industrial buildings**

### **Characteristics**

There is considerable diversity in industrial buildings and the nature of the activities carried out in them also varies greatly. Industrial buildings are mainly designed for processing and storing goods. Buildings where crops are grown and/or stored, or where animals are kept on a commercial basis, also qualify as industrial buildings. Dutch building regulations will be changed significantly pursuant to a scheme that was drawn up in order to greatly



reduce the number of fires in animal houses and the number of animals killed in such fires (*Actieplan Stalbranden 2012-2016*). The Dutch 2012 Building Decree (*Bouwbesluit 2012*) was changed accordingly with effect from 1 April 2014.

Examples of industrial buildings are workshops, storage buildings, warehouses, distribution centres and production halls. Most new industrial buildings are situated on industrial estates. Smaller industrial buildings or workshops (e.g. car workshops) can sometimes be found in residential areas. Most industrial buildings consist of one or two storeys.

Some examples of processes that are performed in industrial buildings:

- *Processing*, e.g. processing bulk goods into individually packed goods, e.g. in a bottling plant or a cigarette factory.
- *Machining*, e.g. converting raw materials and/or semi-manufactured goods in chemical plants, cocoa factories, concrete plants or power plants.
- *Repairing*, e.g. a car workshop.
- *Assembling*, e.g. an installation company, an automotive body assembly plant.
- *Storing*, e.g. storage of raw materials, parcels, end products, and waste products.
- *Transshipment*, e.g. port warehousing and shipping companies.
- *Growing* or raising, e.g. in greenhouses and in livestock companies.
- *Controlling* and checking processes, e.g. in the control room of a production process.

This document does not go into risks associated with storing, producing and/or processing hazardous materials. This also applies to hazards that involve external safety risks.

### Occupancy

The length of time that people spend in a certain type of industrial building varies and depends on different factors, including the nature of the activities that take place in the building. A distinction may be made between production buildings (possibly with shift work), storage buildings and workshops. Buildings where people work on a full-shift rota will have people in them during both day and night. Production companies that do not work on a full-shift rota, as well as storage buildings, are not manned in the evening and at night. Security staff may be present.

The fire risk of industrial buildings is diverse. This is often related to the activity and/or the production process or other processes. The fire risk is determined by such factors as:

- the nature of the substances/materials stored/produced, including their toxicity, flash point and their physical state
- the storage method and/or place of the substances/materials with a fire risk (including the location of flammable substances, storage conditions – pressurised storage, cooled storage – and packaging method)
- the quantity of the substances/materials (fire load)
- sources of ignition.

### **Population**

In general, occupants of industrial buildings are aged between 18 and 65. Most of these occupants will be familiar with the building. The number of visitors is limited. The industrial sector makes use of temporary workers, including employees of contractors, seasonal workers and temps. It is assumed that the occupants are awake, are familiar with the layout of the building, that the majority of them are able-bodied, i.e. able to leave without assistance, and that they have normal intellectual capacities. Furthermore, it is assumed that any less able-bodied people present, as well as visitors, who would not be able to leave without assistance will be helped by other people to reach a safe place in the event of a fire. Only a small number of people will not be able to leave without assistance. The number of people present tends to be low compared to the available area and the evacuation possibilities.

### **Areas requiring special attention**

#### *Sheltered workshops:*

As regards evacuating buildings in the event of a fire, the physical and mental condition of the employees in this category will usually not be a problem. However, this is an area that requires special attention.

#### *Fire load:*

The fire load and the speed at which fires spread can vary greatly. This is something that is to be taken into account in the context of fire safety.

#### *Fire alarm methods:*

In high-noise environments, alarm methods other than the customary acoustic systems must be considered.

#### *Environmental effects:*

Although the environmental effects of fire are not intended to be covered by this document, it is important that attention be drawn to them. The environmental effects of fire in an industrial building depend on various factors, including the nature and quantity of the substances and production present, as well as their usage and storage. Examples are substances that are toxic to aquatic life, or substances/materials and products such as peanuts (that release oil when burnt), plastics (that may release toxic combustion products), radioactive substances, toxic substances and asbestos (in older buildings). Due to the large non-compartmented areas that can be found in this sector, fire and smoke compartmentation should be given extra attention.

## **Buildings for parking/housing vehicles**

### **Characteristics**

Parking buildings come in many shapes and sizes. They are mainly located in densely built up areas, such as shopping, business, sports, and transportation hubs in cities. They are often underground and it is not uncommon for them to be combined with other building purposes, including residential buildings.

### **Occupancy**

The opening hours of parking facilities are related to their environment. They can be used both in the daytime and at night.

### **Population**

In all cases, there will at least be adult occupants present who have a driving license. And furthermore, depending on the actual situation, there will be a diverse population due to the other building purposes and/or the built up environment. The number of occupants and their ages may vary greatly. Young children (of up to about six years old) will usually not leave a building without help. It is assumed that the majority of occupants are able-bodied, i.e. able to leave without assistance, and that they have normal intellectual capacities. They will usually not be familiar with the layout of the building. Furthermore, it is assumed that any less able-bodied people present who would not be able to leave without assistance will be helped by other people to reach a safe place in the event of a fire. Only a small number of people will not be able to leave without assistance.

### **Areas requiring special attention**

Due to the varying materials and fuels in cars, special attention should be paid to the fire load and smoke production if a fire breaks out. Due to the large non-compartmented areas that are typical of parking facilities, fire and smoke compartmentation should be given extra attention. When planning for escape safety, it will have to be taken into account that a (relatively) large number of people may be moving about simultaneously at some moments. This may be, for example, immediately after a theatre show has ended and when all the visitors are in a hurry to return to their cars and go home.

## Group 2: Guest accommodation buildings

### *Characteristics*

Guest accommodation buildings are designed mainly as recreational lodging or to offer temporary accommodation to people. These people's main residence is elsewhere. Examples of types of guest accommodation are:

- hotels and motels
- holiday cottages
- youth hostels
- farms that offer camp site facilities.

### *Occupancy*

The occupancy of guest accommodation buildings matches the purpose of the building. Some guest accommodation buildings serve multiple purposes. Most hotels for example also house conference rooms, a bar, a restaurant and kitchen facilities.

### *Population*

People of all ages, ranging from new-born babies to pensioners, may be present in hotels, motels, holiday cottages, etc. Some other guest accommodation buildings, e.g. youth hostels, generally accommodate young people, aged 14 to 30. Conference centres that also offer accommodation will mainly be populated by adults. The physical and mental condition of the people present is no different from that encountered in normal residential buildings. Given their short stay, guests will usually have limited familiarity with escape routes. The number of people that can be present varies from a couple of people (e.g. one family) to several hundreds of people. Whether any staff are present depends on the type of guest accommodation building. As a rule, holiday cottages have no staff. The staff present at youth hostels and farms that offer camp site facilities will usually be limited to just one manager. Several staff may be present in hotels in the daytime, but at night there will often be only one member of staff available and at some hotels, especially if they are small, there may be no staff at all.

### *Areas requiring special attention*

Sometimes the occupants of buildings that are not intended to be used for guest accommodation want to spend the night in these buildings. Examples of this are groups of people sleeping in schools, sports halls, scouts clubhouses and community centres.

## Group 3: Healthcare buildings and cells and buildings that house cells

### Healthcare buildings

#### Characteristics

In order to describe the situation in the healthcare sector as carefully as possible, the profile of healthcare buildings sketched below is quite detailed. In healthcare, a distinction is made between 'cure' buildings, where there is a focus on examination and treatment (e.g. hospitals) and 'care' buildings where the accommodation purpose prevails. This separation does not necessarily match the distinction made in the Dutch Building Decree between the healthcare purpose and other usage purposes.

#### Cure

The following distinction is made in cure facilities:

- patient facilities where the patient is present:
  - nursing
  - examination and treatment
  - special purposes
- patient facilities where the patient is not present in person
- general facilities.

Examples of this are the organisational entities listed in the Dutch Healthcare Establishments Licensing Act (*Wet toelating zorginstellingen - Wtzi*) such as:

- general hospitals
- academic hospitals
- specialist institutions:
  - specialist hospitals
  - institutions where one specific examination or treatment purpose is carried out, such as radiotherapy centres and central laboratories
- clinical rehabilitation centres
- asthma centres.

#### Care

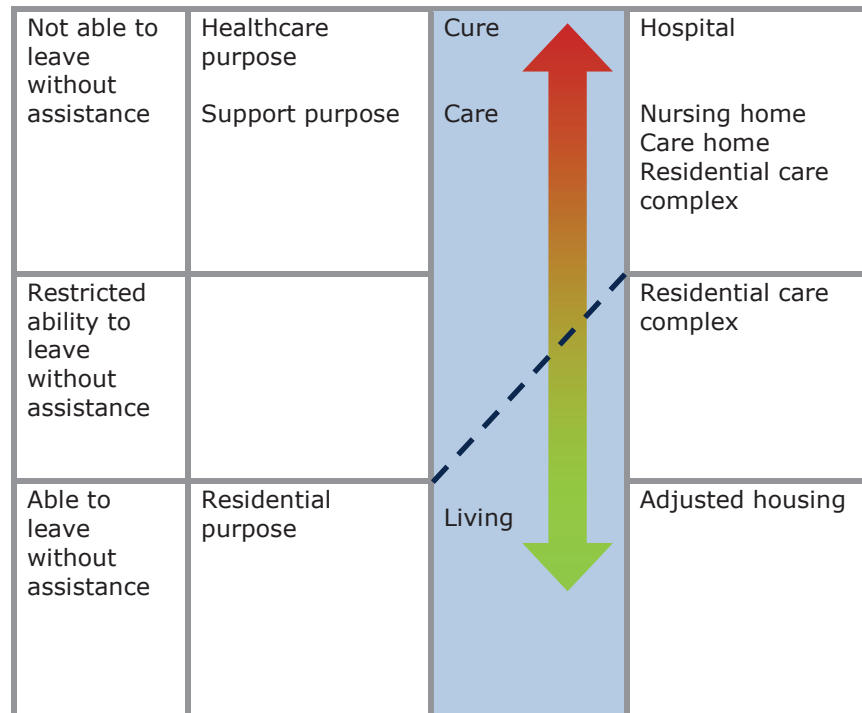
Care facilities provide one or more forms of care, combined with accommodation, and here distinctions can be made based on:

- the target group:
  - somatic disorder
  - psychogeriatric disorder
  - mental, physical or sensory disability
  - psychiatric disorder
  - psychosocial problem
- the purpose or care entitlement provided:
  - domestic care
  - personal care

- nursing
- ADL support
- behavioural support
- treatment
- accommodation
- the intensity of care required, the necessary deployment of staff of the institution:
  - low intensity
  - high intensity
  - extra security
- the accommodation concept:
  - individual
  - small-scale group accommodation
  - ward accommodation.

A continuous scale can be applied to classify the various types of buildings with a residential purpose and buildings with a healthcare purpose.

A broad, indicative summary of various types of healthcare buildings is provided in figure 2. Developments in care can place specific buildings at other positions on this scale. The diagonal line that indicates the boundary between the residential and care purposes means that this boundary is flexible. Facilities in this range are located in the transitional area between living autonomously and depending on care. This area is where there is no clear boundary and so bespoke solutions are possible and necessary. The arrow that changes colour indicates the increase in the need of care from green (low need) to red (high need).



**Figure 2.** A broad, indicative summary of various types of buildings in the healthcare sector

### Types of healthcare buildings

The modern-day healthcare sector uses both purpose-built buildings (healthcare buildings, intramural healthcare), and ordinary, possibly specially adjusted, accommodation in normal buildings and houses (extramural healthcare).

A healthcare building is taken to mean the building or part of a building that is intended for nursing, care, medical examinations and/or treatment or for ADL support or behavioural support for patients (clients). These are the buildings of institutions that come under the supervision of the Dutch Healthcare Inspectorate (*Inspectie voor de Gezondheidszorg*). In addition to buildings where care is provided on the basis of compulsory medical insurance, such buildings may also house private clinics. A clinical healthcare building is taken to be a building or a part of a building that is intended to provide accommodation for patients (clients) who are permanently or temporarily bedridden due to their physical or mental state.

Providing care outside these healthcare buildings is becoming increasingly important and there are many forms of treatment and accommodation that are not covered by these definitions, but that do include the care of patients (clients). This may be care provided in wards or departments housed in healthcare buildings, or in other buildings outside healthcare buildings, such as in business or shopping centres or in regular residential buildings. Besides this, care is offered in many different forms of residence and lodging and in patients' (clients') own homes. This has resulted in a sliding scale between living completely autonomously in one's own home, where care is provided when needed, up to being fully hospitalised and cared for in a healthcare building. What is important in this respect is whether a care provider is responsible for the housing and for the daily care of the people staying in the facility.

Examples of this are:

- A house or apartment for people who are in need of help, mentally disabled people etc. who live on their own – e.g. assisted by professional home carers or relatives who provide care – is not considered to be a healthcare building, but it would be if a care institution had taken full responsibility for the people in question.
- Such a distinction exists in care for the elderly. A residential care complex is a normal or specially adjusted residential building where care is provided when needed. Social organisations like housing corporations and care institutions now provide bespoke care enabling people to continue to live on their own longer than in the past. A care home (or a 'residential care centre' as this tends to be called nowadays) is only intended for people who need more intensive and more permanent care. Admission to such facilities requires a home care assessment.

Between healthcare buildings where care is provided and living on one's own without care (which is not covered by the national healthcare schemes), there is an area where home care is provided without any direct relationship with one's living situation or lodging, and this is the category

of clustered housing with care provided. This latter form of care is provided in buildings that vary from ordinary houses (both individual houses and houses located together in a group), purpose-adjusted buildings, to purpose-built buildings. These buildings tend to be buildings with a residential purpose rather than buildings with a healthcare purpose.

Notes:

- The state of the people at risk (patients or residents) should be the primary concern in the fire protection of buildings and should determine the degree of protection. An example of this might be the fire that took place in the Rivierduinen institute for mental healthcare in Oegstgeest, the Netherlands, on 12 March 2011, killing three patients. See chapter 5, section 4.1 and annex C, Cases.
- Developments over time may create an imbalance as regards fire safety between the people at risk and a building. This imbalance results from the worsening degree to which the people at risk are able to leave without assistance. E.g.: when the Dutch Building Decree was introduced in 1992, homes for the elderly were classified as residential buildings (typified as 'mega-residence') and care homes with nursing (previously known as 'nursing homes') were classified in the healthcare category. But nowadays, the situation is such that the residents of homes for the elderly are not only old, but they will not even be admitted unless they are actually in need of help. Over the years, homes for the elderly have changed into care homes whose population in some wards can be compared to that of a care home with nursing.

### ***The ability to leave without assistance***

In healthcare there is the concept of self-care, i.e. the ability to organise one's life such that the help of others is not needed. This ability to look after oneself may be temporarily or permanently restricted due to one's physical or mental capacity. Fire prevention also recognises a form of self-care, i.e. one's ability to leave a room or building without assistance and within a period of time required for escaping safely. These two concepts are not necessarily compatible, although there will be generally be a certain overlap between people's ability to leave without assistance and their self-care level. An important aspect for both these concepts is whether a person is ambulant – i.e. is able to move to another location on their own – which is typically interlinked with one's physical condition. A person who is permanently or temporarily bedridden due to a disease is not ambulant. A person with a movement disorder is ambulant to a limited degree. In general, people in mental healthcare institutions are ambulant, but due to their mental condition they are not, or not fully, able to leave without assistance in case of a fire. Another important aspect of being able to leave without assistance is the capacity to understand a dangerous situation and this is mainly related to one's mental state. In addition to ambulance and the ability to assess a dangerous situation, the degree to which a person is capable of acting on their own (raising the alarm, fleeing) if a dangerous situation occurs is also important. This means that, for example, although someone is not bedridden, their mental state may prevent them from being able to leave without assistance.



More information about the concept of being able to leave without assistance in the event of a fire is provided in chapter 5, section 4.

The degrees to which patients and clients can leave without assistance in case of a fire can be divided into three groups:

Group A: People who can leave without assistance

Group B: People who are restricted in their ability to leave without assistance

Group C: People who cannot leave without assistance (who may be bedridden).

The ability of patients (clients) staying in a care institution to leave without assistance may vary per institution and even per building and cannot always be directly and unambiguously linked to a care facility or a care target group. However, linking the groups of people A to C to building types enables building types to be classified as residential or treatment environments and to be subdivided. Here, a division into groups A, B and C has been chosen.

***Group A - Residential and treatment environments where residents and clients are able to leave without assistance***

A typical feature of this type of environment is that people live on their own and are responsible for their own living situation. Temporary or long-term care may be provided in this living situation. This will primarily be home care by appointment. In addition, some more intensive care may be provided on a temporary basis. Small-scale care facilities in residential areas are also covered by this category if their scale does not considerably exceed that of an ordinary house. Examples of group A are:

Residential environment	Treatment environment
Houses and residential buildings (where the residents are the owners or have full say over everything that happens in their house, as in tenant housing) where residents live autonomously and fully on their own while still incidentally receiving bespoke help. This includes normal residences as well as specially adjusted housing, such as lifetime homes, stair-free homes and clustered residential facilities.	Healthcare: wards that work to surgery hours and small-scale healthcare facilities with a very open set-up and that might be compared to shops or offices. This includes doctors', dentists' and physiotherapists' practices, etc.

**Group B - Residential and treatment environments where residents and clients are restricted in their ability to leave without assistance**

A typical feature of this type of environment is that people have in some way handed over responsibility for their residential or accommodation situation to a care provider or a third party for an indefinite period of time. Care facilities will be more prominently present in this group (sometimes remotely, sometimes permanently and at a short distance). Care here may include nursing. Examples of group B are:

Residential environment	Treatment environment
Houses and residential buildings where living is combined with a varying degree of care and where a care provider is responsible for at least part of the care provided. This includes residential/care complexes, forms of assisted living and group residences, parent initiatives, small-scale facilities and similar housing.	Healthcare: treatment environments for extramural care, such as daytime activity centres and specialised clinics that provide treatment during the day.

**Group C - Residential, accommodation and treatment environments where residents and clients are not able to leave without assistance (they may be bedridden)**

A typical feature of this type of environment is that the people who live or stay here are fully under a care or nursing institution's responsibility. With the exception of care homes, the people in this type of healthcare institution require intensive nursing and they will definitely not be able to get to safety without other people's help. Examples of group C are:

Residential environment	Treatment environment
Residential and accommodation environments where residence or accommodation is matched with care and where an institution is responsible for the building and for the majority of the care that is provided. Admission to these care facilities requires a home care assessment. This includes residential care centres, care homes and institutions for long-term mental healthcare, and homes for people with a physical, sensory and/or mental disorder.	Treatment environments with an accommodation purpose for non-bedridden clients and patients. These are mainly care homes for the elderly and specialised clinics.
Accommodation environments with short-stay intensive nursing or long-stay care; the latter tend to have a very 'homely' character. This includes patient rooms, psychiatric and geriatric institutions, mental healthcare institutions, daytime accommodation for people with a mental disorder, and rehab facilities.	Treatment environments with an accommodation purpose and a high level of safety for bedridden clients and patients who are treated and nursed intensively here. These are intramural facilities such as hospitals, nursing homes and specialised clinics.

In group A (Residential and treatment environments where residents and clients are able to leave without assistance) care is provided in an autonomous living situation. The care provided may offer bespoke fire safety facilities as required on top of the usual facilities that apply to the living situation in question.

The living situation in group B (Residential and treatment environments where residents and clients are restricted in their ability to leave without assistance) may be comparable to group A, but part or all of the responsibility for the living or accommodation situation has been handed over to a care provider or a third party (if living and care are offered as separate services). This means that the care provider also has a corresponding degree of responsibility for the safety situation.

Note:

Light and, temporarily, more intensive care may also be provided to individual people in groups A and B. However, residents/care recipients in group A continue to be responsible for their own safety as is usual in normal residential situations. In this case, the person in question has made a conscious choice to bear this responsibility themselves and the care provider's task in this respect is then limited to pointing out any safety risks and optionally offering safety facilities to control these risks. The resident may have transferred responsibility for their living and safety situation to a care provider by means of a contract governed by private law for the duration of the treatment. This will be a deliberate choice by the resident of a residence in group A, as a result of which the care provider also takes responsibility for the resident's safety in their own home, next to the care provided, and the residence then becomes a type B building for the duration of the agreement.

The fire safety facilities and measures taken must correspond to the actual people who run the risk, duly considering the group (A to C) they belong to. The possibility of evacuating bedridden residents, patients or client also has to be taken into account. The different forms of care offered are often tailored to the different target groups, and new forms of care are developed as new needs arise. A building may be laid out such that all or only a part of the building has a healthcare purpose, which may include different types of rooms. Modern hospitals are built according to the 'onion model'. This means that the treatment departments are housed in one part of the building, the accommodation wards in another and the outpatient clinic-like departments and consultation rooms have been concentrated in a third part, that is comparable to an office environment.

## Occupancy

Cure buildings in healthcare differ greatly – varying from office-like use to laboratory-like use for small buildings, and from day care centres to closed hospitals for the larger buildings – which makes providing a general description virtually impossible. However, some specific situations are quite common:

- *Special treatment rooms*  
A cure building may contain rooms or departments where special treatments are performed (such as surgery wards, radiology wards and heart monitoring areas) on patients who cannot be relocated immediately in the event of a fire.
- *Visitors*  
There are mostly special visiting hours in the daytime. Individual institutions or wards may also have some visitors at other times.
- *Therapy rooms*  
Special rooms for physiotherapy treatments or other individual or group therapies may be set up in buildings. In general, these rooms are only used in the daytime.
- *Special meetings*  
Church services, congresses (specifically in academic hospitals) and other such special meetings may be held in healthcare buildings at pre-announced times.
- *Movements*  
Patients staying in healthcare buildings may have to move or be moved to other locations in the building for certain treatments (radiology examinations, surgery, special treatments etc.). These movements usually concern individual patients, supported by assistants. If patients have to be moved, a wheelchair or bed is used for this.

Healthcare buildings devoted to care also vary greatly. There is a continuous scale of residential and accommodation situations, ranging from living in one's own home with help, to assisted living and day care to group housing and homes. Both the living situation and the care provided tend to be matched to the client or patient in question. The building is related to the target group's care needs. From a healthcare perspective this can be divided, for indicative purposes, into group buildings for:

- *accommodation with support, care and/or nursing*  
This group consists of people who are able to live on their own to a reasonable degree, and want to do so, but have to be able to invoke care or support 24/7 if necessary. Clients in this group have a disability, a chronic disease or a disease that has stabilised, or feel too vulnerable to be able to function completely independently. The emphasis is on 'living', with some opportunities as regards welfare, service provision and care. The accommodation may be individual or it may be small-scale group accommodation. The care and support are not located immediately in the area where the clients stay, but are quickly available when requested. For the majority of clients in this category it is possible that the accommodation and care functions will be split in due course. As a result, buildings in this category are designed such that the accommodation facilities can easily be sold off to the regular housing market.

- *accommodation with intensive nursing, treatment and/or behavioural support*  
This group consists of people who require intensive care where a 24/7 presence and availability of care are guaranteed. Some examples of people in this group are people who are bedridden and need intensive nursing, people with serious combined problems, people with behavioural disorders, people who are rehabilitating after a stroke or after orthopaedic surgery, or people who have to undergo temporary intensive support and/or treatment in a protected environment.
- *secure accommodation*  
This group consists of people who, due to a combination of an affliction and severe behavioural problems, are a danger to themselves or others, and need to be looked after or treated in a protected or secure setting for a short or long period. The group comprises people with a mental disability combined with severe behavioural and/or forensic problems, people with a, sometimes very severe, psychiatric disorder combined with severe behavioural disorders and aggressive behaviour who are looked after in a clinic for intensive treatment and people with forensic problems who are treated in a forensic psychiatric ward or clinic, or in a forensic rehab centre. Many clients in the category of secure accommodation have some sort of special legal status.

There are also buildings where people from the first two groups are housed together. Some overlap cannot be ruled out, specifically since changes in care needs will not always lead to a relocation.

### **Accommodation concepts**

Where relevant, every group can be divided into three accommodation concepts: individual accommodation, small-scale group accommodation and departmental accommodation.

Individual accommodation implies that people have their own accommodation unit, which is, in principle, intended for one and possibly for two people. As the minimum, an individual accommodation unit consists of a living room, a bedroom, or a combined living/bedroom and sanitary facilities with a shower, washbasin and toilet. There may also be a kitchenette. Accommodation units may be linked to a department or form part of an institution, may be situated on the edges of an institution's grounds, or may be located in an ordinary neighbourhood, where they tend to be clustered.

Small-scale group accommodation involves a small number of clients, i.e. three to six, who run a joint household. These clients have their own living room and/or bedroom, while sanitary facilities may be shared. The accommodation facility will usually have a communal room/living room, its own kitchen or kitchen unit and a smoking room. These facilities are mainly located in ordinary neighbourhoods or on the edges of the institution's grounds. The accommodation facility may also be situated in a more large-scale structure.

In the event of departmental accommodation, a group comprises a maximum of ten clients. One or more groups together form a department. Every group has at least a communal room/living room and a multi-purpose area.

### **Population**

The age of patients and residents depends on the type of care provided in the building. Maternity clinics house newborn babies, whereas the average age of residents of nursing homes tends to be rather high. Hospitals have occupants and patients of all ages, although ages may differ greatly from department to department. The average age in care homes is very high. All age groups can be encountered in nursing homes, day-care centres, residential and accommodation facilities, consulting rooms, practices and outpatient clinics. In general, more intensive and more care is provided as people get older.

The physical condition and mental state of patients in healthcare can vary greatly, depending on the type of building. Many patients in hospitals are not able-bodied. Most patients in mental healthcare institutions tend to be able-bodied (but they are not always able to leave without assistance).

The residents of small-scale residential facilities include disabled and less able-bodied people, some of whom may have a mental disability. It is obvious that elderly people are less able-bodied and care homes may house many wheelchair occupants or other people who need aids to help them move about. Given their high average age, the majority of residents of nursing homes will not be able to leave without assistance in the event of a fire.

Hospitals where people can stay for more than 24 hours may house hundreds of patients. Hospitals usually have 36 to 44 patients in one nursing ward, subdivided into two sub-wards or nursing units. Clustering three units (e.g. up to 60 beds) is not uncommon. A typical patient room will house one, two or four patients. Four is considered to be the maximum. The number of patients per room is decreasing. There is a trend towards single or two-patient rooms.

Nursing homes usually work with groups of a maximum of ten beds. Groups in institutions that provide care to disabled people and in mental health institutions are smaller (no more than six to eight people).

The number of people present in a care home may range from a dozen to over one hundred. There is usually a large number of staff present in the daytime. There are often only one or two members of staff present in the evening or at night.

Protected housing is usually organised in subgroups of four to six clients per residence. These residences tend to be clustered.

The number of daytime staff may vary from just a few (in a practice, at a first-aid station or in a kindergarten) to over a hundred (in a hospital).

Many hundreds of extra people may be present during visiting hours. Most of them will be able to leave without assistance. In the evening and at night, the number of staff will be lower than during the day. In care institutions where people sleep – except small-scale housing facilities – one member of staff will generally be present at night per department or group, plus usually an overall night or group head. During these hours, the total number of staff present in very large buildings with a healthcare purpose may be dozens.

At certain times in the daytime, several dozens of people who may require to be transported by wheelchair or bed may be present in recreational areas, rooms where church services are held etc. However, there will always be staff present who can act immediately, whereas the rest of the building also houses lots of staff who can act immediately in case of an emergency.

#### ***Areas requiring special attention***

Nowadays, lots of elderly people have electric vehicles that are often parked in the direct vicinity of where the owner is. This requires attention to prevent any ‘traffic congestion’ in the hallways and at locations where many people congregate, e.g. near lifts and in stairwells. Vehicles parked in corridors next to the rooms where their occupants are may make the corridors and departments harder to reach, narrowing the corridors with the risk of fully blocking them in the commotion that follows a fire alarm.

Given the relatively short period that patients and clients tend to stay in buildings with a healthcare purpose, they will not be very familiar with the escape routes, even more so if the building is large and complex.

Most residents of care and nursing homes will have spent enough time in these buildings to know how to find their way, but it is doubtful that they will be familiar with escape routes (stairwells). Under normal conditions, they tend to only use lifts. Residents in other residential and lodging situations stay long enough to get to know the escape routes.

## Cells and buildings that house cells

### Characteristics

A distinction can be made between various types of buildings with cell functions:

1. Buildings where people who have committed crimes are locked up:
  - prisons
  - remand prisons
  - forensic psychiatric clinics, including long-stay wards
  - young offenders institutions.
2. Buildings where people who are suspected of having committed crimes are locked up:
  - remand prisons
  - cells in police stations and at airports
  - detention rooms at police stations.
3. Buildings where people stay while awaiting the decision on whether they can stay in the Netherlands or will be deported:
  - special reception and removal centres for asylum seekers and 'body packers' (including cell containers and detention ships)
  - temporary detention rooms in police stations.
4. Buildings where people stay for a short period while waiting to be brought before the Public Prosecutor or Investigating Magistrate for questioning:
  - waiting cells and similar facilities in court houses.
5. Buildings where people who have violated certain military rules stay, usually for a short period:
  - military penitentiary facilities.
6. Buildings where people are nursed and are confined since their mental state requires them to be protected against themselves:
  - psychiatric clinics and forensic psychiatric clinics
  - rehab clinics.

This list is not exhaustive.

These types of cell buildings can be divided into cells where people can stay overnight, like a prison, and cells where people cannot, like detention cells at a police station or a court of law.

Note:

This distinction is important when assessing fire safety on the basis of risks. E.g.: is there a night-time situation when few guards are present in combination with cells that house relatively many flammable fixtures and fittings and consumer goods? Or is there a daytime situation when many guards are present and there are hardly any flammable items?

Depending on the type of building, different rooms may be found in a building that houses cells, including:

- cells, such as residential cells (for one or more people, up to a maximum of eight per cell), observation or penitentiary cells (one person per cell), temporary detention rooms, detention cells, waiting cells (that sometimes house more than one person per cell) and isolation or separation cells (one person per cell)



- rooms where inmates are present, with or without surveillance, such as the work centre, the sports hall, the living/recreational room, the interrogation room, the centre where various services, such as medical care and spiritual aid, are provided and the court room
- rooms in the restricted access area that the inmates cannot access, such as the administrative area that houses the offices and board rooms, the technical rooms, the security desk, the central guard station, static stations and the duty officer's or station sergeant's office.

### Occupancy

Not all types of cells in a building that houses cells are occupied day and night. Cells in courts houses are only occupied when the courts are in session. Somebody who has just been arrested can spend from 30 minutes up to 12 hours in a cell. As a rule, detention rooms in police stations will be occupied for no more than a few hours, and only in the daytime. However, there are also cells where suspects can spend much more time (up to 10 days). Cells in psychiatric clinics may also be in use during the night. In practice, separation cells are only occupied for short periods of a couple of hours up to one day.

The inmates may be allowed to move 'freely' in a certain part of the building, like a specific cell block, during certain parts of the day. They will be under surveillance at such times. The residents have the possibility of visiting each other in their cells or of staying somewhere else in the cell block. Whether the doors to the cells are then closed depends on how the residents behave.

In principle, visitors will only be allowed in the daytime, at set hours, and by appointment. In cell buildings where convicted offenders are housed, the inmates work for a certain part of the day. These buildings also have activity/education rooms where the inmates can do manual work in their spare time, also in the evenings. Lectures may also be attended. Special meetings may be convened in the sports hall or other suitable venues in prisons or remand prisons at certain times in the evenings. How many staff are then present depends on the number of inmates present.

Inmates can only move through the building while under surveillance. When moving groups of inmates, the groups will usually not be more than 26 people (24 inmates + two members of staff).

There are differences in staffing during the daytime, the evening and at night. There may be many people in one room or one area in a prison, remand prison, psychiatric clinic or similar institution in the daytime situation. However, there will always be staff present who can then act immediately while the rest of the building also houses lots of staff who can also act immediately in case of an emergency. Most people who are locked up at a police station, a court of law or a similar building will also be in their cells in the day time and there will then be plenty of staff in the building who can act immediately. The number of staff in the evening tends to be much lower than in the daytime. If evening activities where

lots of inmates are present take place in a prison or remand prison, the staff capacity will be matched to this. However, in a normal situation, the inmates will be under surveillance in the living area or locked up in their cells in the evening. Barring exceptions, people who have been arrested and are held in a police station or a similar location will be in their cells, and will be supervised.

At night, there will only be a minimum number of staff in a cell building. All inmates/people who have been arrested will be in their cells and most of them will be sleeping.

### **Population**

The population of a building that houses cells may range from a couple of people to hundreds of inmates. In general, any single unit or ward of a prison or remand prison houses no more than 24 inmates. The maximum number of patients per group in forensic psychiatric clinics is smaller (around 12). The number of inmates of psychiatric hospitals and institutions depends on their mental capacity. If penitentiary institutions house both men and women, they will be separated from each other. Inmates in correctional institutions or detention centres are aged 18 and upwards (or 14 and upwards in institutions for young offenders). In principle, inmates of psychiatric clinics can be of all ages.

In general, inmates will be able-bodied. They are capable of leaving the endangered area themselves, be it that others (the staff) will have to open the doors to their cells and other doors to enable them to reach a safe location. They are relatively or highly familiar with the layout of the building and have good or reasonably good mental capacities (barring the inmates of psychiatric institutions).

The number of people present in a building that houses cells is determined by the type of building. The number of inmates may vary from a couple (a minor police station) to hundreds (a prison). The number of daytime staff may vary from a couple (a minor police station) to over one hundred (prison / forensic psychiatric clinic). All institutions where inmates are confined will only have a few members of staff present at night.

A distinction can also be made between the number of people in the different rooms. As a rule, a regular cell where inmates also spend the night will house one or two people, but temporary detention rooms may house entire families. Detention rooms and waiting cells may house one to ten people, depending on the size of the room. Larger groups of people, of up to 24 inmates and two members of staff, may be present in living areas/ recreation halls. Visiting halls may contain up to 60 people and film nights or other meetings in prisons may be attended by even more people.

### *Areas requiring special attention*

There is a trend of cutting personnel costs in buildings that house cells. As regards fire safety, this will mainly have an impact on the number of staff at night when all inmates are in their cells. In the daytime situation, there will usually be enough staff in the building to be able to act immediately. However, there is a minimum threshold as regards the number of night-time staff. Given contemporary building conventions and the use of technical aids, the following guidelines apply:

- It must be guaranteed that central guard stations are manned at all times.
- From a personal safety perspective, at least two members of staff have to be present when a cell door is opened. As regards the safety of the guards, their number should be matched to the expected scenarios.
- A group of inmates in a penitentiary environment must not be more than 24 inmates (the normal ward size in practice), otherwise they cannot be handled by only two guards.

If more than one ward is to be evacuated (e.g. in the event of an atrium space and if the inmates cannot stay in their cells), the right number of staff must be present as soon as possible, before the fire services arrive, so that all traffic areas in and to the endangered area are, in principle, cleared of inmates. This latter aspect does not apply to psychiatric hospitals/institutions.

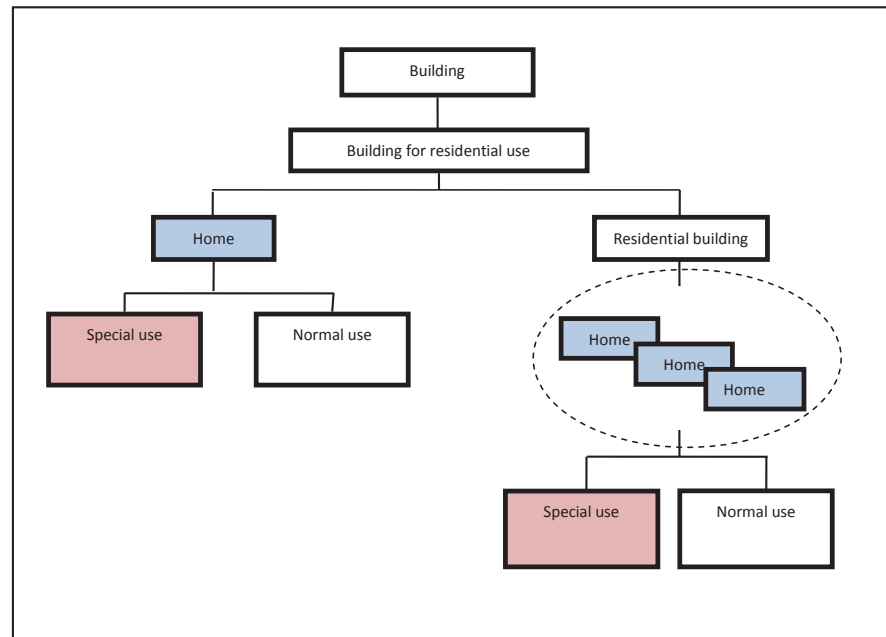
The first version of the 'Cells and buildings housing cells' fire protection concept stated that, in the years prior to this document being developed, there had been a trend of attempts to break out of prison becoming increasingly brutal and violent. Arson did not occur, or only rarely, as part of these attempts. Although it must not be automatically assumed that people who attempt to break out of prison, and are holding hostages while doing so will start a fire thus also endangering themselves, the possible consequences of this should be pointed out. Since the policy of the Dutch Ministry of Security and Justice is not to concede in the event of a hostage situation, it is not completely impossible that a fire will be started to strengthen the hostage takers' demands. As, in principle, the fire services will not act while the endangered area has not been cleared of inmates, a fire may develop unhindered, leading to all kinds of dangers. Initially, the rebellious inmates and their hostages will be endangered and it cannot be ruled out that there will be many casualties. Depending on the architectural facilities, the fire may also spread to the other parts of the building, with even greater consequences.

There is also a tendency for more and more equipment like microwave ovens and refrigerators to be installed in certain buildings that house cells. This equipment increases the risk of fire.

## Group 4: Residential buildings and dwellings

### Characteristics

Dwellings can be separate buildings (on their own plots), or they can be part of a building that is partly or completely intended for residential use. If a residential building contains several dwellings, the dwellings can usually be reached through one or several communal circulation spaces.



**Figure 3** Schematic division of buildings for residential use

Dwellings and residential buildings can be ‘normal’ or ‘special use’ buildings. Normal use or normal residence refers to the type of residential use where at least one person who is able to leave without assistance has their main residence in the dwelling, where the residents know each other well and take responsibility for each other, and where rooms in the dwelling are, in principle, freely accessible. This characterisation attempts to describe that what is ‘normally accepted’: people living in a dwelling as part of a family or in a comparable situation. Examples of dwellings and residential buildings for normal use are:

- detached houses
- terraced houses
- blocks of flats with a communal stairwell that serves as an entrance hall
- flats
- dwellings over offices/shops
- the residential part of a farm.

The special use category can be divided into two subcategories, one where the residents (i.e. the people who run the risk in the event of a fire) can leave without assistance and one where the residents are less able or completely unable to leave without assistance. See figure 4.

Special use	
Residents: - able to leave without assistance	Residents: not able to leave without assistance or restricted in their ability to leave without assistance
Student housing	Residential care building *)
Boarding school	Home for the elderly *)
Company that rents out rooms	Surrogate family units
Shelter for asylum seekers	Boarding school (residents aged < 6)
Convent *)	

\*) In due course, an imbalance as regards fire safety could occur between the people both posing and carrying the risk and the building. This imbalance results from the deterioration in the degree to which the people both posing and carrying the risk are able to leave without assistance.

**Figure 4** Types of special use buildings

### Occupancy

The use matches the purpose of the building. In general, the residents will have lived in it for long enough to be familiar with the escape routes, but in asylum seeker centres, where residents stay relatively briefly, there will be less familiarity with the escape routes. Although the residents of homes for the elderly stay in the building long enough to enable them to find their way, it is highly doubtful that they will be familiar with the escape routes, as these residents virtually always use lifts.

### Population

The category of 'special use buildings with residents who can leave without assistance' houses residents with the same physical capacities and ability to leave without assistance as normal use dwellings. This is different for the category of special use buildings with residents 'not able to leave without assistance or restricted in their ability to leave without assistance', e.g. in homes for the elderly, certain residential care buildings and certain homes that act as surrogate family units. It is obvious that the residents of homes for the elderly have become less able-bodied. These homes house a relatively large number of people who need aids to enable them to move about. Such a distinction is also made in care for the elderly. A residential care complex is a normal or specially adjusted residential building where care is provided when needed. Social organisations like housing corporations and care institutions provide bespoke care enabling people to continue to live on their own for much longer than in the past. A nursing home (or a 'residential care centre' as this tends to be called nowadays) is only intended for people who need more intensive and more permanent care. Access to such facilities requires a home care assessment. Many residents of student housing display behaviour that is not fire safe.

### *Areas requiring special attention*

The category of 'special use' buildings is a tricky category. Buildings in this category are often the subject of discussion as to whether they are normal residential buildings or whether they qualify as 'special' or 'other types' of buildings from a building regulations perspective. In practice, the parties applying for permits tend to predominantly indicate the residence category or an intermediate form that resembles residential buildings. Where this discussion is only held from a legal perspective, without focussing on the people who run the risks of fire, it has little relevance to fire safety. The safety options must correspond to the people who run the risks. E.g.: if the people running the risks are 'not able to leave without assistance' or are 'restricted in their ability to leave without assistance', the fire safety options will have to match this.

Examples of buildings for residential use that, from a fire safety perspective, do not belong to the 'normal use' category are:

- care homes and nursing homes
- residential buildings or residences where the people running the risks are not entirely able to leave without assistance
- homes, such as boarding schools
- buildings/residences that are predominantly used to let rooms or as guest houses. This is a special use/control situation in that, in principle, rooms are locked and residents should not be assumed to know each other well or to take responsibility for each other.



**Annex B**  
**Escape safety analysis model**







## Foreword

The 'escape safety analysis model' as discussed in this annex can be used to carry out a systematic analysis into the escape safety of buildings. This analysis model was initially drawn up by the Netherlands Institute for Safety (NIFV; M. Kobes and N. Oberijé, 2010). The original version contained annexes with a case study of the evaluation of a fire in a football stadium and a comprehensive list of literature references. Further to the original version, this annex also features a phased plan (section 5 of this annex).

## 1. Introduction

Understanding human behaviour in the built-up environment is essential for people who design buildings. This enables them to determine what fire safety measures must be included in the building design. Important indicators of a building's fire safety are the degree to which the building poses a risk for the people present and the degree to which the people in the building can leave without assistance. In the first stage of a fire, the people present in a building mainly have to rely on themselves and on the people in their direct vicinity. External help, e.g. as provided by the fire services, will not be given until a few minutes after the incident has been reported and only if the external service providers are actually alerted. How people behave during the first stage of a fire is the most crucial in determining their likelihood of survival.

Ideally, the occupants of a building discover the fire quickly after it starts, escape as soon as they see smoke or hear a fire alarm, and leave the building through the nearest emergency or other exit. However, in practice, people tend not to display such ideal behaviour when faced with a fire. This also means that any assumptions that a fire safety policy is based on do not necessarily match actual behaviour, since people's behaviour in the event of a fire depends on their physical and situational environment. In order to match the fire safety policy to the actual behaviour that people display when fire breaks out, scientific knowledge of psychonomy should be used to determine which fire safety measures are required. Psychonomy is the science of how people behave and their interaction with their environment. Psychonomy is about discovering the patterns that define human behaviour. These patterns provide an insight into how people process information.

Psychonomy related to fire safety mainly concerns the human perception of fire and the built-up environment. Which fire safety measures have to be taken can only be determined if one has an insight into how the interaction between ambient factors (i.e. the fire situation, the building's design and social factors) affects the degree to which people can save themselves, i.e. leave without assistance, in case of a fire. Furthermore, knowledge is required of the policy measures that support those present in a building in their ability to leave a scene of a fire without assistance. This ability to save oneself from a fire situation is the human ability to observe and interpret signals that indicate danger, to take decisions, and to take actions aimed at surviving a fire situation. This definition is based on the knowledge of the development of human behaviour in the event of a fire. Such human behaviour is related to three crucial phases in the development process, during which the following basic activities occur:

- becoming aware of the danger through external stimuli (period of becoming aware)
- validation of, and reaction to, danger signals (period when a decision is taken)
- performing an action, such as fleeing to a safe place (period of relocation).

The degree to which people are able to leave a building in which there is a fire without assistance is determined by three aspects, i.e. the 'fire characteristics', the 'building characteristics' and the 'human characteristics'. Fleeing is an expression of a behaviour in an attempt to save oneself in a danger situation. This makes the degree of escape safety of a building also dependent on the three aspects listed above. Critical factors that affect escape safety can be identified for every individual factor. These critical factors have been collected in the 'escape safety analysis model'. The model is based on findings from a literature review into the fire safety of buildings and human behaviour in a fire situation.

## **2. Objective, scope and verification**

### **2.1 Objective of the use of the escape safety analysis model**

The 'escape safety analysis model' is used with the objective of systematically analysing the critical escape safety aspects of a building or structure. The model offers a framework for analysis in which all aspects that may influence human behaviour in a fire situation are addressed. Aspects that negatively affect people's ability to leave a scene of a fire without assistance can then be analysed in more detail. This further analysis of the aspects with a negative influence also enables recommendations to be drawn up for improving the building's escape safety.

## 2.2 Scope of the escape safety analysis model

The 'escape safety analysis model' can be used in order to systematically analyse the critical aspects of fire safety in:

- a new building, yet to be built (building design phase)
- an existing building (building use phase)
- an existing building where there has been a fire (fire evaluation phase).

### *Application during the building design phase*

In this phase, the 'escape safety analysis model' can be used to assess the escape safety risks, starting from the characteristics of the building design and the expected population of the building. Furthermore, the model can be used to determine the normative fire and evacuation scenarios, after which these risks and scenarios can be used to determine the necessary fire safety facilities, e.g. in the context of FSE.

### *Application during the building use phase*

In this phase, the 'escape safety analysis model' can be used to assess the escape safety situation in an existing building. The systematic analysis of the critical aspects of fire safety ensures that all aspects that may influence human behaviour are addressed. Next, the aspects that negatively affect escape safety may be used as the basis for improving escape safety in the building.

### *Application during the fire evaluation phase*

If, unfortunately, a fire has occurred in an existing building, the 'escape safety analysis model' can be used to systematically determine or redetermine how the building, fire and human characteristics affect the degree to which people are able to leave without assistance. This enables new data to be collected on fire safety psychonomy. This new data is necessary in order to determine the as yet unknown influences in the current 'escape safety analysis model'. Frequent use of the analysis model in fire evaluations (and practical experiments) should enable the current qualitative (analytical) model to be converted into a quantitative (calculation) model. Besides this, the new fire safety psychonomy data can be used in other existing FSE instruments, such as in evacuation simulation software, and for the further development of FSE instruments.

### *Limitations*

The 'escape safety analysis model' suffers from two limitations that have to be taken into account when applying the model.

The first limitation of the analysis model is that not all properties can be predicted on the basis of the existing literature. For example, for the time being it is not possible to predict the influence of escape route signs. This also applies to the influence of an emergency light system, the size of the building, low occupancy, the user profiles (such as age, sex and profession), the personalities of those present (such as their degree of stress resistance) and their familiarity with the layout.

The second limitation is that using the model results in a qualitative analysis. The results of the quantitative analysis are an objective assessment of the presence or absence of the different critical factors and the quality of those critical factors present, with a subjective assessment of the effect of the absence of factors and the quality of the factors present on the degree of escape safety. This means that the results are not expressed as objective and measurable probabilities and impacts of the different critical factors on the degree of escape safety. Besides this, the reliability of the qualitative weighting of the impacts of different critical factors depends on the expertise of the user of the model. Actually, this limitation also applies to the application of quantitative models, including calculation models, since the degree to which the result can be relied upon also greatly depends on the user's expertise.

### 2.3 Verification: use test by means of a case study

The application of the 'escape safety analysis model' has been tested in practice by using it as an analysis framework when evaluating the fire at the Euroborg football stadium in the Netherlands (April 2008). This test showed that applying the 'escape safety analysis model' resulted in a systematic analysis. And furthermore, it provided a clear overview and understanding of the influence of different aspects of the degree to which those present in a building can leave without assistance in the event of a fire. This knowledge is necessary in order to determine the fire safety policy and the policy for the implementation of fire safety engineering (FSE).

Although the football stadium is a building, it is not a 'typical' building. For example, it is not an enclosed space, as a result of which the fire development, the smoke spread, way finding, and other behavioural aspects may be different than in a confined space. However, the fire evaluation has shown that the predictions in the model, which is based on studies of people's abilities to leave without assistance when there is a fire in a building, match the factors that played a role in how people tried to flee the fire in the football stadium.

The influence of the personalities of the people present, their social bonds (i.e. which supporters belonged together), their alertness (i.e. were any supporters under the influence of drink or drugs?) and their physical positions (some supporters were standing while others were sitting) could not be established in the fire evaluation in question due to a lack of research data. But this should not be taken to imply that the predictions in the 'escape safety analysis model' are incorrect.

### 3. Factors critical to escape safety

#### 3.1 Theoretical model

The 'escape safety analysis model' provides a summary of the critical factors that influence escape safety when there is a fire in a building. The summary of these critical factors is shown in figure 1.

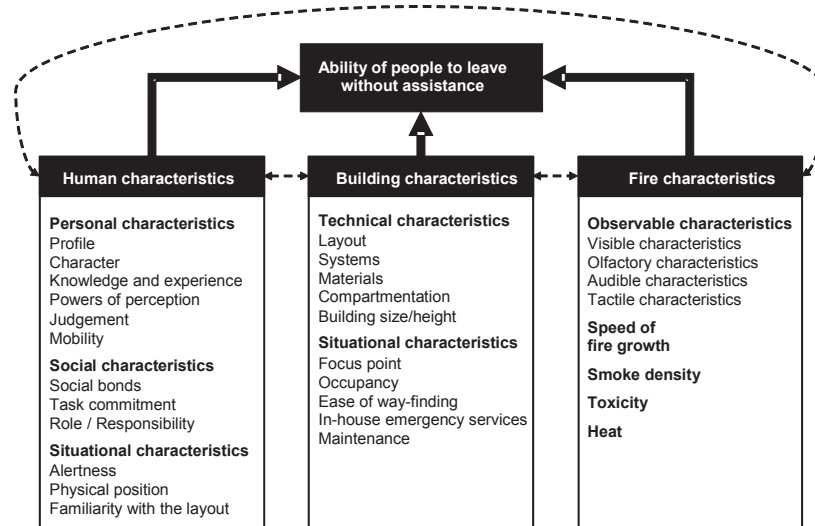


Figure 1 Factors critical to escape safety

An extensive description of the critical factors is presented in the sections below. Section 3.2 presents a description of the fire characteristics, section 3.3 describes the building characteristics and section 3.4 contains a description of the human characteristics.

#### 3.2 Description of the fire characteristics

Fire is an important reason why people would want to flee a building, but the effects of a fire restrict people in their opportunities to safely exit a building. This means that fire affects people's ability to leave without assistance. When considering the fire characteristics, the critical factors affecting people's ability to leave a scene of a fire without assistance are:

- the observable characteristics of fire
- the speed of fire growth
- the smoke density
- the toxicity of the fire
- the heat released during a fire.

##### Observable characteristics

The observable characteristics can be divided into characteristics that can be seen, smelled or heard. These characteristics help determine how fast a fire will be discovered. Feeling is also part of people's powers of perception, but this is found not to have a strong influence on the discovery of a fire. Various experiments have shown that an evacuation signal is not perceived as a clear indication that there is a fire. Smelling smoke and seeing flames are stronger indications that a fire has broken out and that fleeing is necessary.

### *Speed of fire growth*

There is a formula, that starts from exponential growth, that can be applied to calculate how fast a fire will grow. The starting point of this formula is that the speed of fire growth depends on the fire growth coefficient of the material involved in the fire. Nine standard fire curves with different growth speeds have been distinguished. The fire curve of a fire that grows at an ultra high speed applies to fires involving synthetic materials, such as polyurethane (PU).

Actually, the fire curves are just an arithmetic approach to fire growth and do not necessarily represent your 'average' fire growth. However, the speed of fire growth is an important factor in determining the fatality of a fire, since fatal fires often involve a situation that survivors refer to as 'sudden and very fast fire spread'. Examples of fatal fires where the fire spread very quickly are the fire in the Cocomanut Grove Dance Hall (Boston, 1942) where 490 people died, the fire in DuPont Plaza (Puerto Rico, 1986), where 83 people fell victim to the flames, the fire in a discotheque in Gothenburg (Sweden, 1998) with 63 fatalities, the fire in café 't Hemeltje in Volendam (the Netherlands, 2001), that claimed 14 lives, and the fire in The Station nightclub (Rhode Island, 2003), where 100 people were killed.

### *Smoke density and toxicity*

Most fatal casualties of fires are due to people inhaling smoke and toxic combustion gases. Other effects of exposure to combustion gases and smoke are:

- Loss of responsiveness; loss of consciousness.
- Slower walking speed or changes in behaviour, such as choosing a longer escape route.
- Psychological impediments to escaping due to how the person in question perceives the dangers.
- Long-term physical effects, such as cancer, lung damage and the immune system being affected.

Being able to see less well due to smoke density and breathing problems due to toxicity affect people's ability to find their way. Incident evaluations have shown that people are often confronted with smoke when trying to flee from a fire. Some people who had to walk through the smoke to get out stated that they changed routes, or even went back, while trying to escape from the building. They did so due to breathing problems, the fact that they could not see well, or out of fear or other reasons. Experiments have shown that people will tend to walk along a wall if they cannot see far. It has also been proven that people who are confronted with smoke and heat walk more slowly than people who flee from a situation where ambient conditions are normal. Experiments have shown that the use of sound beacons makes people walk faster again. Smoke also affects people's 'distance of sight'. Distance of sight is the distance within which objects can still be seen well. Practical studies have revealed that the distance of sight for people who are familiar with the environment should be at least 3 to 5 metres. When people are not familiar with the environment, as is the case in venue buildings, a distance of sight of at least 15 to 20 metres is required. Practical studies by Rasbash have shown that the distance of sight should

be at least 10 metres, regardless of whether people are familiar with the environment or not.

### **Heat**

People who are exposed to heat for a very long period will experience several negative effects, starting with physical effects such as sweating and a rapid heartbeat. This will worsen their ability to take decisions. If people are exposed to intense heat for a prolonged period of time, they will become injured, e.g. receive burns, which may eventually cause them to die.

On the other hand, heat may also be the main reason causing people to flee. For example, a video recording of the fire in the Euroborg football stadium shows that the crowd did not start to evacuate the stadium until the heat had become exceptionally high. One supporter was heard to say: “Isn't it very hot?” and shortly after that: “Let's get out of here!”. That was the moment when the supporters fled the stands to get to the exits. This is also the moment in the fire development process where environmental conditions may quickly become fatal. Environmental conditions are fatal if the ambient temperature is higher than 120 °C, heat radiation exceeds 2.5 kW/m<sup>2</sup>, or the oxygen content in the air has dropped to below 12%. Environmental conditions may quickly become fatal if foam rubber or plastics become involved in the fire. For example, video footage of the fire in The Station nightclub shows that environmental conditions had become fatal there within a mere 90 seconds of the fire starting. Measurements conducted on the test fire in a reconstruction of the nightclub showed that the maximum heat flux had been reached after 61 seconds, the temperature had exceeded 120 °C after 76 seconds, and that the oxygen content in the air had dropped to below 12% after 87 seconds.

## **3.3 Description of the building characteristics**

The second factor that influences people's ability to leave without assistance is the building itself as an environmental factor. A building is a physically enclosed environment where people are present and activities are performed. A building's physical characteristics form the environment in which people may display behaviours connected with their self-preservation. This physical environment offers the primary condition for the possibility of surviving a fire situation. When considering the building characteristics, the factors that are critical to people's ability to leave without assistance in case of a fire are the building-specific situational characteristics and the physical characteristics.

### ***Building-specific situational characteristics***

The building-specific situational characteristics consist of the building's occupancy, the ease of finding one's way (way finding), the presence of a focus point, the possible support provided by in-house emergency responders, and the extent to which fire safety facilities are maintained. One meaning of the word 'occupancy' is the number of people in a building. In literature, a direct relationship has been found between high occupancy and a high risk of fatality of a fire. Finding one's way is fairly easy when the building has an easy to understand layout, making it easy for people to find



their way. There are five categories of environmental factors that may make it less easy for people to find their way:

- distance of sight
- degree of architectonic differentiation, i.e. the presence of unique building characteristics that can be used for orientation purposes
- the use of signage and location indicators
- the layout or floor plan
- familiarity with the building.

There is a focus point if people's attention is oriented towards one central point, as is the case in a theatre or a class room. If the actors (or teacher) continue their performance (or lesson), the audience (or the students) will be inclined to remain seated. In-house emergency response is provided by a special group of people who take action if an emergency occurs. The in-house emergency response organisation is made up of staff who are normally already present in a building. These members of staff have been trained in various incident control activities, including fire fighting and coordinating the evacuation of a building. The assistance of a properly educated and trained in-house emergency response organisation has a positive effect on the speed of evacuation and the use of emergency exits. Furthermore, the proper functioning of any fire safety measures taken is essential to enable people to flee safely from the building if a fire breaks out. However, in practice, fire prevention facilities tend to be maintained quite poorly.

### **Physical building characteristics**

The physical characteristics of a building that determine people's ability to leave without assistance are mainly the building's layout, the systems and materials in the building, the compartmentation, and the size of the building. The building's layout also includes such elements as how escape routes are indicated and set up, where emergency and other exits and stairwells are located, and how these are constructed. Incident evaluations have shown that emergency exits that are not used as exits in a normal situation will not be used during an emergency either. This specifically applies to exits that are locked with facilities/devices to prevent their 'other than intended use' in a normal situation, such as exits connected to an alarm signal.

The systems in a building can be divided into escalators and lifts, fire reporting and evacuation alarm systems, emergency light systems, and sprinkler systems. These systems can be used for most types of user functions/buildings. Since other systems, such as heat and smoke ventilation systems, overpressure systems, fire hatches etc. are mainly used in buildings with specific fire safety problems, these systems will not be discussed here. As regards fire and evacuation alarm systems, it is a known fact that the sound of alarm bells or a slow whoop signal is seldom recognised as a danger signal and is mostly ignored by those present in a building. A fire alarm with a spoken message or a person giving targeted instructions is taken most seriously. Although, as a rule, the use of escalators and lifts

is not allowed in a fire, incident evaluations have shown that people do tend to use them in order to escape from the scene of the fire. It has also been found that the use of escalators and lifts can shorten the evacuation time and can save lives, particularly in very high buildings. If the use of escalators and lifts is allowed in the event of a fire, extra measures will have to be taken to ensure that such systems can be used safely. Studies into the evacuation of the WTC towers in 1993 and 2001 have revealed that more people than had been assumed had problems escaping via the stairs. Most people will become tired, especially if they have to bridge a great difference in height. An aggravating factor is that most people in high buildings use the lifts to go to their floors, due to which they do not know where the stairwells are located. The materials characteristics concern the combustibility or non-combustibility of the materials used to build, finish and furnish the building. Compartmentation concerns the physical barrier to prevent fire and smoke spreading. No information was found in literature about how a building's size influences people's ability to leave without assistance if a fire breaks out. However, it is safe to assume that it will be quite a complex task to find one's way in a big building with lots of curves and forks.

### 3.4 Description of the human characteristics

In addition to fire as a hazard factor, the human factor is also important when it comes to how well people can leave a scene of a fire without assistance, since this is all about how people behave in those circumstances. When assessing the degree to which people can leave without assistance, individual people's behaviour, i.e. their personal characteristics, is considered as well as the behaviour displayed by a group of people (social characteristics). When considering the human characteristics, the factors that are critical to people's ability to leave without assistance in case of a fire are the personal characteristics, the social characteristics and the person-specific situational characteristics.

#### *Personal characteristics*

The main personal characteristics are the characters of the people in the building, their knowledge and experience, their powers of perception and judgement, and their mobility.

Three character features play a role, the main one of which is the distinction between being a leader or a follower. In a fire situation, most people display the typical characteristics of followers. Followers do not immediately react to symptoms of danger, but wait for others before taking action themselves.

The second character feature that is important is a person's stress resistance. Stress resistance also includes the capacity of coping with heightened stress levels, i.e. the power not to lose control when under stress and to reduce the negative effect of stress. Stress levels can be heightened in the event of a fire if a person's information processing capacity is pushed beyond its limits and because the person is confronted with a situation that they are not

familiar with. Excessive psychological stress may negatively affect cognitive processes and people's reactions. A heightened stress level is not the same as panic. Panic can be defined as irrational, illogical and uncontrolled behaviour. In 1954, Quarantelli was the first social scientist who found that there was no proof that the phenomenon of panic occurred in the event of large-scale incidents, after which other researchers, such as Sime, Proulx and Auf der Heide, confirmed the idea that no panic occurred.

The third feature is faith in one's own capacities. This starts from the assumption that most people have an inner system that enables them to keep their thoughts, emotions, motivations and actions under control to a certain extent. This internal control is based on personal knowledge, feelings and biological characteristics. Furthermore, the actions and influence of our surroundings may also play a role.

The power of perception is a personal property that enables people to detect signals that indicate danger. The use of alcohol, drugs and narcotics temporarily reduces our powers of perception. Powers of perception are also low in people who are asleep. Our power of judgement is our ability to assess the threat of dangers. If a fire is perceived as being extremely dangerous, the people present will be more inclined to flee. However, most people find it hard to assess how dangerous a fire is. Their knowledge and assumptions of the speed of fire growth and smoke development are often incorrect, causing people to put themselves into more danger than necessary. People's mobility may be temporarily affected if they are in a poor physical condition or they may need help if they are bedridden or locked up in a cell.

### **Social characteristics**

The main social characteristics are the social bonds among the people present in the building, their degree of task commitment and their roles or responsibilities. Evaluations of incidents have shown that, in an emergency, people tend to be more readily inclined to work together instead of acting on an individual basis. If there are strong social bonds among the people present, as would be the case with people who are each other's relatives, people will try to react as a group for as long as possible. There is task commitment when people hold on to role patterns or role expectations. Incident evaluations have shown that, when faced with unexpected events, people will initially hold on to the role expectations that match the purpose of the building they are in. These role expectations reduce the likelihood that danger will be recognised and increase the time required to process information about the fire danger. For example, people will often be inclined to first finish the activity they are doing before starting to evacuate the building. Furthermore, people whose role or function is such that they have organisational responsibility in a building, such as waitresses and department managers, are inclined to also assume this responsibility during an emergency. A special role or responsibility is that of in-house emergency responder. Providing the in-house emergency response organisation with proper education and training is found to positively impact on the speed with which a building is evacuated and the use of emergency exits.

### *Person-specific situational characteristics*

The main person-specific situational characteristics are a person's alertness, physical position (passive or moving) and their familiarity with the layout. The main indicator for alertness is whether people are sleeping or awake. When people are sleeping they have a very low level of alertness as to what is happening in their direct vicinity. Alcohol, narcotic drugs or medication also have a negative impact on people's alertness. People who are lying down or sitting will be less readily inclined to leave a room than people who are already standing or walking. The information about the influence of people's familiarity with the building layout is somewhat vague. It is a known fact that people will usually take the route they are familiar with. Personal experience may have caused a person to be highly familiar with the building, but it may also lead to selective knowledge of the building, as a result of which alternative escape routes are ignored. Furthermore, people's familiarity with a building may cause them to wait for a very long time before attempting to leave the building since they do not feel seriously threatened by the fire. It has also been found that people who are familiar with their environment, e.g. in their own home, are more inclined to walk through smoke than if they had not been familiar with the building's layout.

## **4. Operationalising the factors critical to escape safety**

### **4.1 Degree of escape safety**

The factors from the theoretical model (see figure 1) have been operationalised based on the available literature. This means that, while determining which factors influence escape safety, the factors have been defined in terms that can be measured. The influences of the three types of characteristics on the degree of escape safety have been determined on the basis of the results from a literature review. As the available literature provides very little insight into the extent of the influence of the characteristics, the result, i.e. the degree of escape safety, has been formulated as a qualitative unit instead of as a quantitative, i.e. arithmetic, unit. The degree of escape safety has been divided into four quality levels:

- High: This means that the condition of a factor leads to a good or better level of escape safety.
- Neutral: This means that the condition of a factor has no effect on the degree of escape safety.
- Low: This means that the condition of a factor leads to a poor or worse level of escape safety.
- Unknown: This means that the effect of the condition of a factor was not clearly defined in the literature studied.

## 4.2 Operationalising the fire characteristics

The influences of the fire characteristics on the degree of escape safety have been summarised in table 1.

**Table 1** Influence of fire characteristics on escape safety

Factor	Condition of factor	Degree of escape safety
Observable characteristics	Observable	Neutral
	Not observable	Low
Speed of fire growth	Slow	High
	Fast	Low
Smoke density	Low	High
	High	Low
Toxicity	Low	High
	High	Low
Heat	Low	High
	Average	High
	High	Low

### *Observable characteristics*

If a fire can be observed, people will be more capable of reacting to the fire in an adequate manner, thus improving their ability to leave without assistance. If one's ability to leave without assistance is at a high level, this has a positive effect on escape safety. This also means that the level of escape safety is low if fire signals cannot be observed. Although it is assumed that fire signals that are easy to observe will lead to a high degree of escape safety, several incidents have shown that people hardly, or inadequately, react to such observable signals.

### *Speed of fire growth*

A high speed of fire growth leaves little time to successfully escape. This means that a high speed of fire growth will result in a low level of escape safety.

### *Smoke density*

High smoke density negatively affects escape safety for various reasons, for example, because smoke affects people's vision.

### *Heat*

The heat of a fire may trigger people to start evacuating the building. Therefore, an average level of heat that is within what a human being can physically handle has a positive effect on escape safety.

### 4.3 Operationalising the building characteristics

The influences of the fire characteristics on the degree of escape safety have been summarised in tables 2 and 3.

**Table 2** Influence of technical building characteristics on escape safety

Factor	Condition of factor	Degree of escape safety
Layout: escape route signs	Present / Not present	Unknown
	High perceptibility	Unknown
	Low perceptibility	Low
Layout: emergency exit	Entrance / Regular exit	High
	Emergency exit	Low
	Locked (to prevent 'other than intended use')	Low
Layout: emergency route	Free from smoke	High
	Not free from smoke	Low
	Accessible	High
	Blocked (due to storage)	Low
Systems: fire alarm	Slow whoop signal	Neutral
	Spoken message	High
	Not present	Low
Systems: emergency lighting	Present and works	Unknown
	Not present / does not work	Unknown
Systems: sprinkler system	Present and works	High
	Not present / does not work	Neutral
Systems: smoke and heat ventilation systems	Present and works	High
	Not present / does not work	Low
Systems: fire hose reels	Present and works	Neutral
	Not present / does not work	Low
Materials: combustibility	Non-combustible	High
	Combustible	Low
Materials: toxicity	Not toxic	High
	Toxic	Low
Compartmentation (for people outside the compartment with the fire in it)	Present and works	High
	Not present / does not work	Low
Size of the building	Small / Large	Unknown

**Table 3** Influence of situational building characteristics on escape safety

Factor	Condition of factor	Degree of escape safety
Focus point	Not present	Neutral
	Present and used for evacuation instructions	High
	Present and activity or show continues	Low
Occupancy	Low	Unknown
	High	Low
Ease of way-finding	High	High
	Low	Low
In-house emergency response team	Present and adequate	High
	Not present / inadequate	Low
Maintenance	Adequate	High
	Inadequate	Low

The manner in which escape routes are indicated and how they are set up (e.g. in the form of corridors) are a part of the layout of a building, as are emergency exits. The literature review has led to the assumption that an evacuation that is planned or calculated such that the building will be evacuated through emergency exits will lead to a low degree of escape safety. This is because people usually attempt to flee the building through the familiar exits and hardly ever use any emergency exits. If the evacuation is planned exclusively via the regular exits that people also use in normal situations, people will be familiar with these exits and will use them by intuition if there is a fire. A building where evacuation has been planned via the regular exits will result in a high level of escape safety.

#### 4.4 Operationalising the human characteristics

The influences of the human characteristics on the degree of escape safety have been summarised in table 4.

**Table 4** Influence of human characteristics on escape safety

Factor	Condition of factor	Degree of escape safety
Profile: gender	Male / female	Unknown
Profile: age	Old / middle-aged / young	Unknown
Character: leadership	Leader	High
	Follower	Neutral
Character: immunity to stress	Present / Not present	Unknown
Character: faith in one's own capacities	Present / Not present	Unknown
Knowledge and experience	Present	High
	Not present	Low
Powers of perception	Good	High
	Poor	Low
Judgement	Good	High
	Poor	Low
Mobility	Good	High
	Poor	Low
Social bonds	Individual	High
	Group	Low
Task commitment	Weak	High
	Strong	Low
Role / Responsibility	Responsible position	High
	Guest	Low
Alertness	High (awake)	High
	Low (sleeping / under the influence of alcohol, drugs, etc.)	Low
Physical position	Active	High
	Passive	Low
Familiarity with the layout	Familiar	Low
	Unfamiliar	Unknown

#### **Observation, assessment and relocation**

The first phase in the process of evacuating a building due to a fire is that fire signals are observed. If the people present in the building have good powers of perception, they will be able to discover the fire. As a result, good powers of perception lead to a high degree of escape safety. The second phase of the evacuation process is that people interpret the signals and decide what to do. As a result, good judgement leads to a high degree of escape safety. The third and last phase in the evacuation is the actual relocation. If people are mobile and are capable of going to another location on their own, they can flee to a safe environment. As a result, good mobility leads to a high degree of escape safety.

#### **Social bonds**

Strong social bonds among the people in the building may have both positive and negative effects on escape safety. There is a positive effect if people help each other get to safety. A negative effect may occur if people wait for each other to flee together or if people re-enter a burning building to find lost friends or next of kin.

#### **Task commitment**

A high degree of task commitment negatively affects escape safety: if people are inclined to not give up the activity they are doing, they will find it hard to switch over to another 'task', i.e. the task of getting to safety.

### **Familiarity with the layout**

A general assumption is that if people are familiar with the layout of a building, this will have a positive effect on escape safety. But studies have shown that there is not always such a link between a high level of familiarity with a building and a high level of escape safety, since a high level of familiarity with the layout may also cause people to ignore the exits they pass on their regular route and try to reach their regular exits out of the building. If such a regular exit is not the nearest exit, a person's familiarity with the building's layout may negatively affect escape safety.

## **5. Phased plan for applying the analysis model**

The application of the model requires a phased approach where the degree of escape safety is matched to the fire characteristics, technical and situational building characteristics and human characteristics, after which an analysis is made. Use the tables 1 to 4 from section 4 of this annex for this. This concerns the following steps:

**Table 5** Phased plan for applying the analysis model

Step 1	Determine the condition of the factor for every characteristic
Step 2	Determine the degree of escape safety for every factor
Step 3	Analyse the possible alternatives for the factors that lead to a low degree of escape safety
Step 4	Analyse which alternatives that have resulted from step 3 lead to a high degree of escape safety and apply the most suitable alternative.

### **Indicative example:**

This concerns a multifunctional building which may hold a large number of people. The building is put to diverse uses, including sports, concerts, exhibitions and trade fairs.

Step 1 is taking stock. Step 2 shows, among other things that, in the event of a fire, the combination of a high speed of fire growth, high smoke density, combustibility of materials and high occupancy are the critical factors that result in a low score. The low score results from the use of materials, especially due to interior furnishing objects and activities during exhibitions and fairs. The user has indicated their wish to put the building to the most flexible use possible, preferably without any restrictions. Step 3 is part of the analysis phase and is about suggesting alternatives. This may concern a wide range. This example is based on two alternatives, i.e. one aimed at removing the cause as effectively as possible and the other one aimed at actively fighting the cause. Step 4, another part of the analysis phase, is where the most suitable alternative is sought. Removing the cause as effectively as possibly is not easily compatible with the flexible use desired. What remains is actively fighting the cause. This can best be expressed by an automatic fire extinguishing system, as a result of which the score can be qualified as high.





**Annex C**  
**Case histories of fires**





## Case histories of fires

Chapter 5, Risks in the event of a fire, defines four groups of buildings based on the dominant risk factors, i.e. whether the people present are able to leave without assistance and whether they are awake or asleep. The four groups of buildings are:

1. Buildings with people who are awake and are able to leave without assistance
2. Buildings with people who are sleeping and are able to leave without assistance
3. Buildings with people who are sleeping and are not able to leave without assistance
4. Buildings with residents who are sleeping and are able to leave without assistance

The buildings have been classified into one of these four groups. Profiles of the different types of buildings can be found in Annex A.

The various risks of these groups of buildings are described in chapter 5. A brief analysis of the causes and effects of fire, based on statistics, is also provided. Besides statistics, case histories are also a good risk analysis instrument.

This annex provides a summary of relevant case histories in the form of a brief description of the incident and the characteristic fire safety aspects. The full report on the Infopunt Veiligheid (Safety Information Point) website of the NIFV is also referred to. The case descriptions are a direct representation of the information contained about them in the relevant reports; they are not case reviews by the authors of this knowledge document. Where there are several reports on an incident, only the report produced by independent research is referred to, e.g. reports by the Dutch Safety Board (*Onderzoeksraad voor Veiligheid*) or a State Inspectorate. Other investigative reports were used and are referred to for situations where no report resulting from an independent report was available. Several reports have been referred to in a few cases where such extra reports answered an additional research question or shed a different light on the incident.

The basic criterion for including an incident in this annex was that it had to be a recent case in the Netherlands. However, some less recent cases that are relevant to the current situation in the Netherlands are also discussed. It should also be clear that this list of case histories is not an exhaustive list.

The following case histories have been included in this annex:

***Buildings with people who are awake and are able to leave without assistance; office buildings, educational buildings, public buildings, and industrial buildings***

1. Amsterdam, Kingdom Venue discotheque, 13 May 2005
2. Rotterdam, parking garage on Lloydstraat, 1 October 2007
3. Doetinchem, Gamma shop premises, 12 February 2008
4. Tynaarlo (De Punt), boathouse, 8 May 2008
5. Delft, TU university building, 13 May 2008
6. Groningen, Gravenburg school, 16 October 2010
7. Haarlem, the Appelaar parking garage, 26 October 2010
8. Helmond, 't Speelhuis theatre, 29 December 2011
9. Rotterdam, Vodafone business premises, 3 April 2012

***Buildings with people who are sleeping and are able to leave without assistance; guest accommodation buildings***

10. Noordwijk, Huis ter Duin hotel, 25 January 1990
11. Den Haag, Vogel guest house, 16 September 1992

***Buildings with people who are sleeping and are not able to leave without assistance; healthcare buildings, cells, and buildings that house cells***

12. Haarlemmermeer, Schiphol cell complex, 26 October 2005
13. Almelo, Twenteborg hospital, 28 September 2006
14. Oegstgeest, Rivierduinen institute for mental healthcare, 12 March 2011
15. Nieuwegein, De Geinsche Hof nursing care centre, 27 June 2011

***Buildings with residents who are sleeping and are able to leave without assistance; homes and residential buildings***

16. Haarlemmermeer (Hoofddorp), block of houses at Koning Willem I Laan, 16 August 2008
17. Zaanstad, Schiermonnikoog block of houses, 4 October 2008
18. Maassluis, house at Het Hoge Licht 103, 11 August 2012

# 1

## Amsterdam 13 May 2005 Kingdom Venue discotheque

### Description of the incident

The automatic fire detector detected a fire at about 04:30 a.m. on Sunday morning, 15 May 2005. Using fire alarm panel 4 in the entrance lobby, the fire wardens soon discovered that a fire had started in a cold store in a basement that had not been in use as a cold store for many years. The door to this cold store was later found to be open. The fire was accompanied by heavy smoke. The smoke soon spread throughout the building. As the club closed at 05:00 a.m., all but 200 visitors had left the premises by that time. Smoke from various holes in walls and floors filled the venue rooms. The ventilation system increased the spread of the smoke. This made both visitors and the discotheque's staff notice that something was wrong. The two fire wardens present (they had been hired by the discotheque; they were not fire service personnel) took the initiative to evacuate the building. The emergency exits in the venue rooms were not used during this procedure.

The approximately 200 visitors could leave the building through its main exit in good time. The cloakroom was constructed such that it was closed automatically if the fire alarm was raised. The rolling shutters in the desks where visitors could collect their belongings were lowered then. After consulting with the fire wardens, seven members of staff went back into the building to retrieve certain valuables, such as the money from the cash registers and personal belongings. They inhaled smoke while doing so. They were treated on the spot a little later by ambulance personnel who had already arrived.

Shortly after the fire alarm, which was automatically forwarded to the fire service's regional control room, the fire wardens contacted this control room by phone at 04:30. The fire wardens agreed with the control room that the fire service would not turn out until the rooms where the fire was supposed to be located according to the automatic fire detectors had been inspected. After fire wardens arrived at those rooms and established the actual size of the fire, they requested that the fire service still be deployed. By then, the heavy smoke had already made it impossible to access the basement.

In the end, the visitors and the staff had already evacuated the building before the police, fire service and ambulance arrived on the scene. The fire service arrived at 04:53 a.m. The fire was put out shortly after this. The actual fire did not grow to a large size. The smoke was detected by a smoke detector in the basement and was indicated on the fire alarm panel at the entrance to the building. The fire produced heavy smoke. The smoke spread through the basement areas and ended up in the crawl space and from there into the ventilation system of a large part of the building.

### Fire safety characteristics of the incident

There were things wrong with the electrical facilities. Wires were hanging loose in many places. Although this could no longer be established, this faulty electrical wiring is assumed to have caused the fire.

The fire and smoke compartments did not comply with requirements, enabling the smoke to spread quickly throughout the building. The fire alarm system did not control the ventilation facilities, allowing the smoke to quickly spread through the ventilation system and throughout the building as well.

No evacuation plan was available. As it was almost closing time, only 200 people were left in the building. The occupancy permit stated that more than 1400 people were allowed to be present.

The report drawn up by the Dutch Safety Board can be found at <http://www.infopuntveiligheid.nl/Publicatie/DossierItem/14/4629/brand-disco-kingdom-venue-15-mei-2005-te-amsterdam.html>

**Description of the incident**

Residents of the Harbour Edge building on Lloydstraat reported a fire in the parking garage under their building at 04:16 a.m. When the fire service arrived, the flames had already reached the outside of the building. The fire service first focussed on saving the residents who were still in the building. Five private cars fully burnt out in the fire; one car burnt for 75% and one car had been scorched and had sustained melting damage. The building structure was severely damaged by the heat of the fire. Part of the floor collapsed during, and sometime after, the fire.

**Fire safety characteristics of the incident***Fire development*

The material in the building did not significantly influence the fire development. The fire load consisted of the cars present. The fire development did not comply with the basic assumptions of the regulations (as regards the fire curve) and guidelines for the fire safety of parking garages (as regards the fire load of cars). The basic assumptions for the fire load of a car and the applicability of the standard fire curve are highly open to question. Pursuant to the regulations and the guidelines, a fire of this size was not to be expected.

The regulations for ventilation in naturally ventilated parking garages are not based on circumstances during a fire such as on Lloydstraat. The presence of a fire alarm system would have contributed to the fire service arriving at the scene earlier. This would have enabled the fire to be contained to a smaller size and it would have resulted in less damage to the structure and lower consequential loss for the residents.

The fact that there was no vestibule in front of the stairwell led to a situation where the smoke got into the stairwell, thus making it more difficult for residents to flee.

*Construction*

The most prominent damage was the excessive cracks in the hollow-core slabs. There were horizontal cracks from void to void and vertical cracks extending from the voids to the undersides of the slabs. The underside of a major section of the slabs affected fell down. The prestressed steel wire ropes also came loose from the construction and fell down. Furthermore, the hollow-core slabs at some distance from the fire and the façade elements near the fire incurred splash damage, sometimes of a depth of several centimetres. The depth of the splash damage in the hollow-core slabs is often as deep as the voids; large areas of the front reinforcing steel in the wall elements are exposed. The steel THQ beams and steel corner sections supporting the floors were protected with fire resistant sheeting from beneath. No visible damage occurred to these steel parts.

The Efectis report can be found at <http://www.infopuntveiligheid.nl/Publicatie/DossierItem/14/488/onderzoek-naar-de-brand-in-een-parkeergarage-aan-de-lloydstraat-in-rotterdam.html>

**Description of the incident**

There was a major fire in the Gamma DIY store in Doetinchem on the afternoon of Tuesday 12 February 2008. The entire building burnt down and was lost, inclusive of all its contents. The fire did not claim any casualties. The fire was characterised by a very fast fire development. The local fire service was alerted and a unit was at the premises within the customary time and acted in accordance with the standard instructions. Nevertheless, it very soon became clear that there was nothing this unit could do and it could only try to prevent the fire from spreading to adjoining premises. For all the parties involved, this was a surprising outcome of a turnout in response to an automatic alert. These alerts are usually generated at such an early moment that the fire service can still limit the damage.

Eyewitnesses first saw the fire in a shelf with flammable substances. One eyewitness said that she noticed little flames in the shelf at one metre high. She told her husband, who was walking further down in the store. He then told a shop assistant that there was a fire in the paint department. At the moment when the employee was at the burning shelf with a fire extinguisher in order to put out the fire, flasks sprang off the shelf and caught fire. This caused the surroundings and the items on the shelf on the other side of the aisle to also catch fire. The fire then spread extremely quickly as more and more flasks ruptured, spreading burning liquid. At some time, within one minute, the fire alarm system was triggered and the evacuation alarm went off. At that moment there were four customers and ten members of staff in the premises. They fled from the building.

The first fire appliance arrived on the scene ten minutes after the fire had been reported automatically. That was eleven minutes after the first flames had been detected. The fire service kept the adjoining plots wet in order to prevent these premises catching fire. The fire was under control after two hours. The entire store premises burnt down. Only the left-hand side wall, adjoining a garden centre, was still left standing. The adjoining premises were saved.

**Fire safety characteristics of the incident**

*Load-bearing structure:* the load-bearing structure of the premises was made of concrete instead of steel. The load-bearing structure failed after 20 minutes – instead of after 30 minutes as expected. The reason of this early failure must be studied.

*Partitioning structure:* the wall between the Gamma premises and the adjoining garden centre premises had a 240-minute resistance to fire penetration and fire spread instead of the 85 minutes required. The 85-minute resistance to fire penetration and fire spread had been based on a fire load calculation in which the flammable substances had not been included. The partitioning wall was still standing after the fire, which lasted some two hours, and prevented the fire from penetrating to the garden centre.

*Fire alarm system and smoke and heat ventilation:* the reporting to the central control room, the evacuation alarm, the flash units (to mark the fire service entrance) and the smoke and heat ventilation system all worked. With the exception of one door, the doors were not opened for the smoke and heat ventilation system (to supply air).

The report drawn up by the Apeldoorn fire service can be found at <http://www.infopuntveiligheid.nl/Publicatie/DossierItem/14/631/onderzoek-brand-gamma-doetinchem.html>



**Description of the incident**

The Tynaarlo fire service turned out to attend a fire in a boathouse of a water sports company in De Punt in the afternoon of 9 May 2008. Although the firefighters saw a lot of smoke coming from the boathouse when driving to the scene of the fire, upon their arrival they initially thought that the fire was not as bad as they had feared. The crew commander decided to send four of his crew into the building to assess the risks and extinguish the seat of the fire, if any. Shortly after they had entered the boathouse, the firefighters were surprised by a sudden, explosive fire spread. Three of them were trapped by the fire. They did not manage to escape from the burning building, nor could their colleagues save them. After they had used up the available air in their BA sets, these three firefighters died from suffocation.

The fact that they were surprised by the sudden fire spread played a major role in this unfortunate event. If they had foreseen the sudden fire spread, they would not have entered the building and the accident would not have happened. However, the crew commander and his crew did not notice any signs of an impending disaster. They considered the situation to be absolutely safe.

The fire started in the warehouse. It initially grew forcefully, but then it was smothered as only a little fresh air entered the warehouse. In the meantime, the fire produced lots of unburnt fire gases that flowed through the open door from the warehouse into the main room of the boathouse for many minutes and accumulated there under the roof, at some distance from the fire. While spreading under the roof, the fire gases mixed with fresh air to form an explosive air/ fire gas mixture.

When the fire service arrived, the fire was actually in a phase of seeming rest. Where the smoke had still been billowing out through the opening of the large tilting door only a minute before, no smoke at all could now be seen at the façade. The crew commander and his crew interpreted the situation as safe, failing to notice the smoke that had accumulated under the roof. The fire in the warehouse reached a next peak in its development shortly after the firefighters had entered the boathouse, causing the smoke that had accumulated under the roof of the boathouse to ignite explosively. A violent fire along the entire length of the boathouse followed. The fire was concentrated in the large door opening, cutting off the way by which the firefighters would have been able to return. The Dutch Safety Board identified the fatal sudden fire spread as a fire gas explosion.

**Fire safety characteristics of the incident**

The reports about this fire do not consider fire prevention aspects. However, this is an important incident from a fire prevention perspective, since it has reopened the discussion about the use of sandwich panels with a polyurethane infill as insulation materials. Many think that the use of polyurethane caused the fire gas explosion, but this is not a unanimous conclusion. Nevertheless, there seems to be a causal connection between the use of polyurethane, some configurations of which satisfy the requirements set in the building regulations, and the occurrence of a fire gas explosion.

The report drawn up by the Dutch Safety Board can be found at <http://www.infopuntveiligheid.nl/Publicatie/DossierItem/14/692/onderzoek-de-punt-brand-scheepsloods-door-de-onderzoekraad-voor-veiligheid.html>

The report of the Helsloot Committee of Inquiry can be found at <http://www.infopuntveiligheid.nl/Publicatie/DossierItem/14/4606/-de-punt-brand-scheepsloods-door-de-commissie-helsloot.html>

**Description of the incident**

A fire broke out in the building of the Faculty of Architecture of Delft University of Technology (TU) on Tuesday 13 May 2008. The in-house emergency responders evacuated the building and the fire service was called. The fire service tried to fight the fire from within the building for some time, but had to withdraw due to the risk of collapse. The fire grew quickly. The fire spread further upwards, whereas falling burning materials enabled the fire to also spread to lower storeys. The fire probably spread so quickly due to the high fire load, which was partly due to the type of ceiling, the type of floor, and the fact that a lot of wood had been used in the building. On top of this, there was no sprinkler system and preventative measures were mainly aimed at enabling effective evacuation. The fire resistance measures were supposed to last for a while, but they were not designed to permanently stop the fire. Nobody was injured. However, a large part of the complex collapsed and eventually the entire building was lost.

**Fire safety characteristics of the incident**

The faculty did not have an occupancy permit. Granting such a permit was a slow procedure and neither TU Delft nor the local council (and the fire service) sufficiently supported this procedure. However, all the fire safety measures planned – but one – had been implemented at the time the fire broke out. Fire resistant glazing was being installed in the stairwells at the time of the fire. This work was planned to be completed by mid-2009.

The fire did not claim any casualties, also thanks to the fact that the building was evacuated successfully by TU Delft's in-house emergency responders. The fire safety measures that had been implemented by the Technical University focussed on enabling safe evacuation and not on preserving the building if a major fire broke out. The investments aimed at evacuating proved their worth.

A large number of factors caused the initial fire to grow into a very large and uncontrollable fire in a short time. No matter how hard people tried to limit the consequences, in the end, the building could not be saved. The circumstances under which the fire had to be fought were not conducive to a good result (limited preventative measures, high fire load, insufficient water pressure, flashover, falling glass, a riser that had burnt through, hard to reach from the outside).

The COT report can be found at <http://www.infopuntveiligheid.nl/Publicatie/DossierItem/14/4617/brand-bij-de-faculteit-bouwkunde-van-de-tu-deft.html>

**Description of the incident**

A major fire raged in the Gravenburg school on Maresiusstraat in Groningen on Saturday morning, 16 October 2010. The entire school building was destroyed by the fire. One of the most frequently asked questions after the fire was: 'How could this fire grow so fast in a relatively new premises?' The fire started on the outside of the building. The fire spread via the outside, along the building façade, and then penetrated into the different compartments of the building. In particular, it was the strong wind that caused the fire to spread quickly inside the façade structure. Given the heavy smoke and high temperatures in the building, a defensive attack was decided on. When it became clear that the premises was beyond saving, it was decided to cease the suppression effort and enable clean and complete combustion.

**Fire safety characteristics of the incident**

The investigation focussed on the preventative link in the safety chain and the fire development. The following questions were answered for this:

*To what extent did the fire compartmentation and the façade structure satisfy statutory requirements?*

- There were pine battens behind the copper façade and the false ceiling under the first upper floor. They did not comply with fire propagation class 2, but with class 4.
- NEN 6068 considers heat radiation as the only heat transfer mechanism. However, in this fire, the fire immediately reached the timber battens on the lower side of the façade, enabling the fire to spread inside the façade structure.
- The fire compartments did not comply with the building regulations. The false ceiling under the first upper floor had not been sealed at the fire partition level. The connections between the outer walls and the floors of upper storeys were not sealed using a fire resistant structure, enabling the fire to penetrate into the building.

*How did the outer wall structure contribute to the fire development?*

- The façade structure's contribution to the fire was essential for the fast spread and the destructive result of the fire. The façade assembly and the materials used contributed to the fire development, enabling the fire to spread to several fire compartments. The thin wooden parts and the large volumes of air that could pass through them (chimney effect) contributed to a fast fire growth. The roof structure hardly contributed to the fire at all.

*To what extent does existing legislation allow for measures to be taken to prevent such a fire in the future and/or reduce its consequences?*

The Fire Research team made the following recommendations:

- Design and construct a building using timber parts or other materials that comply with fire propagation class 2 for a sufficiently long time.
- Have the entire façade structure assembly tested.
- Make sure that the outside of the structure cannot catch fire easily.
- Pay equal attention to vertical fire compartmentation as to horizontal fire compartmentation.
- Continue the horizontal fire compartmentation through the façade structure.

The report drawn up by Safety Region Noord- en Oost-Gelderland can be found at <http://www.infopuntveiligheid.nl/Publicatie/DossierItem/14/4632/brandonderzoek-vensterschool-gravenburg-groningen.html>

**Description of the incident**

A major fire raged in the De Appelaar parking garage in Haarlem on 26 October 2010. The fire started in a car on floor -2 of the parking garage. The car's owner tried to find a fire extinguisher to suppress the fire but could not find any and finally had to leave the parking garage. The enormous heat made the fire very difficult to fight. Nobody was injured. In total, 26 cars were lost to the flames.

**Fire safety characteristics of the incident***Prevention*

Most elements of the building permit complied with the prevailing regulations. Some conditions ensured a higher level of safety than intended by the legislator in the prevailing Building Decree and the municipal building regulations. The legislator's objectives were not satisfied as regards the element of fire compartmentation. The grounds on which the fire compartment size (more than 1000 m<sup>2</sup>) was established were insufficiently substantiated. The building permit required four-fold ventilation. The level of ventilation that was actually implemented was more than four-fold, i.e. the permit's requirements were complied with.

Progression in knowledge and understanding about the fire safety of parking garages might have resulted in the municipal Prevention Department being aware that the configuration of this parking garage needed some adjustments in order to comply with the latest new understanding about preventative fire safety for repression in enclosed parking garages of more than 1000 m<sup>2</sup> in size. On this basis, it would have been worth considering adjusting the deployment procedures and the attack and accessibility maps for this parking garage in the event of a fire.

*Use of preventative facilities during the attack*

During the incident, the fire operation commanders thought that the ventilation system was conducive to an attack inside the building. This was confirmed by the information about this on the accessibility maps. When arriving at the scene of the fire, the fire operation commanders were surprised to find much more smoke and heat and much poorer visibility than expected.

There was an extra, synoptic panel on the ground floor. Every layer of the parking garage was divided into four segments. The panel did not 'retain' the information as to which detector was activated first and which segment was concerned. When several segments were activated at the same time, due to the very fast smoke spread in the garage, all the four LEDs on the parking level concerned lit up and it was no longer clear in which segment the fire had started. Upon arrival, the fire service inspected the panel and saw that all the LEDs were lit and it was no longer possible to retrieve the information about the exact location of the fire. This would only be possible by carrying out an assessment.

All the stairwells, except one, stayed virtually clear of smoke. The fire service made use of several stairwells. Some of the dry risers in the parking garage were used during the repressive attack.

There were fire doors between the different floors. Since they were closed at the time of the fire, there was sufficient to good visibility on parking layer -1 during the entire incident.

The NIFV report can be found at <http://www.infopuntveiligheid.nl/Publicatie/DossierItem/14/1890/rapport-brand-in-parkeergarage-de-appelaar-.html>

**Description of the incident**

The fire service's control room received an automatic fire alarm report (smoke detector) at 18:13:08 (6:13:08 p.m.) on 29 December 2011. This alarm originated from a theatre, 't Speelhuis, situated on Speelhuishuisplein 2 in Helmond. While firefighters were preparing to turn out, the control room received a manual fire alarm report at 18:15:17 and several calls on the emergency number 112 at 18:17:13. The people calling in said that they saw heavy smoke coming out of the building. Upon arriving the fire service saw thick black smoke coming out of the roof. The crew commander found a fire alarm panel with all LEDs lit. The first attack crew found that the fire in the auditorium had a considerable seat and that there was a lot of smoke.

As it was not immediately clear whether there were still people in the premises, the attack crew started to attack the fire inside the building, but, in view of their own safety, they had to give this up after a short while. Falling objects, an enormous fire load and extremely high temperatures made an inside attack impossible. At the same time, the message was received that there was nobody inside the premises any more. The attack crew recounted that they felt like they were on the set of the film *Backdraft*. The fact that fresh oxygen was drawn in, the flapping doors and their inhaling of smoke were the signals for them to cease the offensive attack inside the building and to switch over to a defensive tactic.

The fire had started on or near the PA desk in the auditorium, probably due to the electric equipment overheating. The fault might have been in the electrical connection or in the band's equipment. Heat may have accumulated in a tube amplifier. The exact cause could not be determined since all the equipment had been destroyed by the fire to such an extent that it could not be examined any more.

**Fire safety characteristics of the incident**

The theatre had a fully monitored fire alarm system with direct reporting to the fire service control room. The system featured the possibility to temporarily deactivate the detection operation. This is allowed to be used around a theatre stage to prevent smoke and other effects during a show from leading to false alarms. This feature must be set by hand in advance, after which some groups of smoke detectors are deactivated. When the time set on the timer (max. 12 hours) has elapsed, detection is activated again automatically.

Over the stage in the auditorium there were two smoke doors of 2x1 metres. They served to quickly remove smoke from the stage and were/are not obligatory fire service requirements to enable safe evacuation. These smoke doors were controlled by means of two optical detectors over the stage. The smoke doors could also be opened manually. A bypass switch could be used to deactivate the smoke door control function. These smoke doors were opened using magnets and had to be closed manually.

The fire started between the moment when the sound engineer left the auditorium (at about 5:15 p.m.) and the first fire alarm outside the auditorium (6:12 p.m.). Since the detectors in the auditorium had been temporarily deactivated, the fire could grow in these 57 minutes before being reported by another group of detectors outside the auditorium (compartment). This enabled the fire to grow into a major fire that was beyond control. Since the PA desk had been built up amidst the chairs, the fire could spread easily through the foam in the chairs. The hot fire gases accumulated against the ceiling. The wooden panelling on the walls also contributed to the fast fire spread. Flashover occurred at some point in time after which the entire room was ablaze. The smoke doors opened at a certain moment, enabling a chimney effect.

The report drawn up by the Brabant-Zuidoost fire service can be found at <http://www.infopuntveiligheid.nl/Publicatie/DossierItem/14/4607/brand-t-speelhuis-helmond.html>

**Description of the incident**

At 05:04 a.m. on Wednesday 4 April 2012, there was an automatic fire alarm from a business premises at Caïrostraat 2 in Rotterdam. The first fire service unit arrived on the scene seven minutes later to find a blazing fire in the part of the premises that was later found to be Number 4. The fire quickly spread via the building's roof structure and this was accompanied by a lot of smoke. The fire was not brought under control until several hours later, at 2:50 p.m., and the fire service stopped damping down at about 4 p.m.

This was not just a regular fire, but one whose consequences would affect a major part of the Netherlands, since the business premises at Number 2 housed a strategic Vodafone telephone switch. The spread of the fire required that the power to this switch be cut. A large amount of telephone equipment became unusable due to fire gases and fire extinguishing water. The consequence was that some 700 Vodafone telephone masts in the Zuid-Holland area were down, cutting hundreds of thousands of Vodafone customers off from their cell phone and internet connections for a long time.

**Fire safety characteristics of the incident***Fire safety level*

The premises was a standard business premises consisting of a steel main load-bearing structure with steel façade elements and profiled cladding sheets. The building consisted of one fire compartment of some 2500 m<sup>2</sup> and had been divided into two separate business areas. The indoor partitioning structure held out reasonably well, but had not been constructed as a fire resistant partition as no requirements had been set on it in this regard.

Vodafone's part of the building had been provided with some additional and supra-statutory fire safety facilities, such as an automatic fire alarm system and a gas suppression system. However, although these technical facilities served to detect and suppress a fire in this room with its extra high protection level, they did not offer a sufficient level of safety against the threat of a fire from outside this room.

Fire gases and fire extinguishing water penetrated into Vodafone's part of the building due to the fire. Although the telephone switch was in a fully climate-controlled room, the indoor 'envelope' was not sufficient to prevent this.

*Legislation and regulations*

As the premises complied with all the statutory provisions from the Dutch Building Decree and the Environmental Management Act, the fire in the building developed and acted as could be expected of such a premises. However, the overall fire safety level, consisting of structural, technical and organisational measures and facilities, had not been sufficiently coordinated with the special risks as regards the part of the building at Number 2. There are no statutory provisions for this.

The report drawn up by the Rotterdam-Rijnmond Safety Region can be found at <http://www.infopuntveiligheid.nl/Publicatie/DossierItem/14/4616/brand-carostraat-in-rotterdam-op-4-april-2012.html>

**Description of the incident**

In the late afternoon of Thursday 25 January 1990, a fire started in the central part (the restaurant section) of hotel Huis ter Duin in Noordwijk. A very heavy storm, which grew to hurricane force at one point, was also raging. Initially, the fire did not look like it would be a serious incident. However, during the first attack, some 20 minutes after the first fire appliance had arrived, the fire unexpectedly spread very quickly. As a result, the fire service had to withdraw from the building as quickly as possible.

The fast spread of the fire caught three members of the Noordwijk municipal fire brigade by surprise and they were killed. Once the building could be accessed again, a search was started and they were found. The location in which they were found indicates that all three of them attempted to escape by the attack route. They had failed to use a safer escape route via the closest emergency exit. One of the firefighters who had been killed was not wearing a compressed air breathing apparatus. Although earlier assessments of the location had ruled this out, two more new fires were found in the basement under the restaurant section and a fire started in a photo shop at some 200 metres from the hotel, probably due to fire spread by wind. Putting out these fires took until 4 a.m. of the next day, not taking into account the damping down.

**Fire safety characteristics of the incident**

Due to the time pressure when finishing the construction of the restaurant section of hotel Huis ter Duin, there was not enough time to perform all the necessary checks. No occupancy permit pursuant to the decree on fire prevention had been issued for the building. The situation found after the fire was such that a number of partitioning walls that should have been fire resistant failed to comply with several requirements.

The air conditioning system had several cartridge fuse-operated fire valves. One of these fire valves was in the partitioning structure between the nightclub and the adjoining vertical shaft. The cartridge fuse worked, but this does not mean that no smoke and flammable gases had been spread through the building via the air conditioning system in an earlier stage, especially since the system had already been deactivated earlier.

The report drawn up by the Fire Service Inspectorate (Inspectie voor het Brandweerwezen) can be found at <http://www.infopuntveiligheid.nl/Publicatie/DossierItem/14/4618/brand-hotel-huis-ter-duin-te-noordwijk-1990.html>

**Description of the incident**

Fire broke out in the De Vogel guest house at Scheepmakersstraat 22 in The Hague at about 04:30 a.m on 16 September 1992, eventually killing eleven residents. Seven people were injured so badly that they had to be admitted to hospital. Half the guest house burnt down. One of the residents admitted to having set fire to the building.

Deliberate arson (the use of an incendiary liquid) caused a fire greater than normal, turning into a blaze in a very short time. Given the materials used in the building and its layout, as well as the absence of fire resistant partitions, the fire could grow and spread very quickly from the moment it was started. The absence of fire resistant partitions between the stairwell and the adjoining public areas, and the long time until the fire was reported to the fire service, enabled fire and smoke to spread through the building unhindered. In particular, the smoke could access the rooms very easily via the open connections between many of the rooms and the false ceilings. The low fire resistance of the doors (maximum 8 minutes), combined with the overhead window panels with even lower fire resistance, definitely contributed to the fast spread of the fire to the rooms.

**Fire safety characteristics of the incident**

The fire service had demanded a number of fire safety facilities after a site assessment based on the proposed building occupancy, i.e. 29 bedrooms for 30 people and the third floor for private use (not a part of the guest accommodation facilities). Based on this, the fire service decided not to close the establishment, since there was a second escape route (cage ladder) on the second floor. The situation in the premises at the time of the assessment, especially the number of residents (30) and how they were spread over the premises, related to the then current fire safety situation (including the availability of the second escape route) and was no reason for the fire service to recommend closing the establishment for a period during which the facilities should be implemented.

The investigation after the fire showed that the occupancy situation during the term of one year specified for applying the facilities differed from the situation at the time of the site assessment by the fire service and the occupancy stated in the application by the operator. The application referred to 29 bedrooms for 30 people and private use of the third floor which was therefore not a part of the guest accommodation facilities. However, at the time of the fire, several rooms on the third floor, the attic, were being used as sleeping quarters for guests. It was also found that hardly any fire safety facilities had been completed on the floors that were being used at the time of the fire.

For example, the stairwell had not yet been isolated from the corridors that ended up in the stairwell. The existing doors had very low fire resistance and had not been replaced yet. Many rooms were still interconnected via the false ceilings. The powder extinguishers had not been inspected in the past twelve months. The cage ladder still had not been replaced by spiral stairs and evacuation using that ladder was only possible by going through residents' rooms and by using a key cabinet that had no key in it.

The report drawn up by The Hague fire service can be found at <http://www.infopuntveiligheid.nl/Publicatie/DossierItem/14/4615/rapport-grote-brand-scheepmakersstraat-22-den-haag.html>



**Description of the incident**

By midnight of 26 October 2005, all 298 inmates of the Schiphol cell complex had been locked into their cells. Most cells in the K-wing, where the fire broke out that night, held two inmates. One resident was locked in in cell 11 that night. The fire alarm system in the cell complex detected a fire in the K-wing at 11:55 p.m. About one minute later, the inmate of cell 11 pressed the intercom button to call for attention. Smoke could be seen coming through the cracks around the door of cell 11 at about the same time. The fire quickly grew into a major fire that killed 11 inmates who could not be freed from their cells by the prison officers. However, the guards managed to open 21 of the 26 cells, enabling 32 inmates to leave their cells. Fifteen people in total, both guards and inmates, were injured and one wing of the building was destroyed.

**Fire safety characteristics of the incident**

The risks as regards fire safety could not be shown to have been sufficiently taken into consideration prior to building the cell complex. The J- and K-wings did not satisfy the fire safety requirements of the building legislation. The main differences from the law involved compartmentation (the size of the wing), the resistance to fire penetration and fire spread between the cells and the corridor, the walking distances, and the possibilities of escaping. An equivalent alternative was only provided for where the maximum walking distance of 22.5 metres was exceeded. This alternative was a smoke and heat ventilation system. However, its specifications were insufficient and it did not work during the fire.

The risks as regards fire safety were insufficiently taken into consideration, and cannot be demonstrated to have been taken into consideration at all, when developing and fine-tuning the building plan. The risks were also communicated insufficiently with the operator (no demonstrable instructions of use). For example, opening a cell door negated the sub-fire compartmentation of the cell.

Fire safety was addressed during the implementation phase (building plan and construction) of the J- and K-wings, but the owner failed to take sufficient action as regards the fire safety aspects that different parties had discussed. An example of this is that ventilation grilles with fire resistant properties were not fitted by the subcontractor and the owner failed to check this. The owner unjustly assumed that the TNO test of the cell container assured fire safety for the entire wing. The principal did not demonstrably ensure that its contractors (architect, builder, etc.) had sufficient specific and current knowledge of both the relevant building regulations and the specific risks of the cell complex.

The smoke and heat ventilation system should have been tested by TNO as specified in the building permit. As TNO was never ordered to do so, this test did not take place. For example, the architect had an insufficient up to date understanding of the fire safety requirements that apply specifically to a building that houses cells, although his professional code did require this. The K-wing was built on the basis of a building plan that had not been fully elaborated and in which the details of the fire safety aspects had not been provided.

The report drawn up by the Dutch Safety Board can be found at <http://www.infopuntveiligheid.nl/Publicatie/DossierItem/14/487/brand-cellencomplex-schiphol-oost.html>

**Description of the incident**

A patient underwent minor surgery in an operating theatre in Twenteborg hospital in Almelo on 28 September 2006. The patient had been given a local anaesthetic and had been secured to the operating table to enable the surgical intervention. Fire broke out in the anaesthesia supply column during the surgery. The fire's development was furthermore intensified by the leakage of pure oxygen at a pressure of 5 bar. The enormous heat that is inherent in such a fire caused the plastics of the column itself, as well as equipment near the column, to also catch fire very quickly. This caused heavy smoke.

Saving the patient from the operating theatre was severely frustrated by the fact that she had been secured to the operating table for this specific surgery and the 300 kg table was fixed to the floor. An attempt to make the table mobile failed. The staff in the room did not manage to put out the fire nor to shut off the oxygen supply. Due to the toxic smoke and the extreme heat, they had to get themselves to safety without having been able to evacuate the patient. The patient was beyond saving and died due to the fire.

**Fire safety characteristics of the incident**

The surgery ward complied with the requirements of the 2003 Building Decree and the requirements of the occupancy permit. However, complying with these requirements does not guarantee the possibility of safe evacuation for patients who are not able to leave without assistance. The surgery ward did not comply with the 'requirements' of the Dutch outlook on fire safety for healthcare institutions (Brandveiligheidsvisie Gezondheidszorg - draft v.l.3.0) since there was only one possibility to evacuate patients who are not able to leave without assistance to an adjoining safe fire compartment instead of two.

- The escape route signs only pointed to the fire stairs. However, this route is unsuitable for evacuating patients who are not able to leave without assistance from the surgery ward.
- The escape route that was suitable for evacuating patients to the adjoining safe fire compartment was not marked. In some cases, this route had to be found by 'trial and error'. The people who attempted to evacuate patients from the operating theatres were first faced by doors which were too narrow for beds.
- The only door through which patients unable to leave without assistance could be evacuated was the door in the fire compartment partition. This required it to be opened repeatedly, although it should actually remain closed for it to fulfil its fire and smoke resistance purpose.

The combination of partitioning into fire compartments and the evacuation of patients who are not able to leave without assistance to an adjoining safe fire compartment found here is quite common in healthcare institutions. This satisfies the requirements, but it does not seem to have been given sufficient thought, since the adjacent compartment serves to house patients that have been evacuated from the burning compartment. Here, because the fire resistant partition door needs to be repeatedly opened to let patients through, this compartment will also slowly be filled with smoke.

The report drawn up by the Dutch Safety Board can be found at <http://www.infopuntveiligheid.nl/Publicatie/DossierItem/14/4630/brand-in-een-operatiekamer-twenteborgziekenhuis-almelo-28-september-2006.html>

The Dutch Health Inspectorate's report can be found at <http://www.infopuntveiligheid.nl/Publicatie/DossierItem/14/4628/brand-in-operatiekamer-8-van-het-twenteborg-ziekenhuis-te-almelo.html>

**Description of the incident**

A fire started in a patient room in the Intensive Care ward for elderly people at about 9:37 p.m. on 12 March 2011. Three patients died due to this fire. The smoke spread quickly through a part of the building and soon there was nothing the staff could do. They had to leave five people behind in the burning wing. Two of them died on the spot, while the other three patients were saved from the fire by the fire service. One of them died a few days later.

The ward where the fire started was part of a building housing 16 patients, eight in one wing and eight in the other wing (all at ground floor level). Two permanent members of staff were at work at the time of the fire. The fire started in one of the patient rooms, near a bed. Some patients were in their own rooms and others were in the living rooms when the fire started.

The staff did not manage to suppress the fire in the room and started to evacuate the residents. Because the door to the room with the fire was left open, the smoke spread quickly throughout the wing and the in-house emergency responders had to abort the evacuation and wait for the fire service to arrive.

**Fire safety characteristics of the incident**

The direct causes that led to this dramatic result were a mattress that was not fire retardant and in-house emergency responders who did not follow procedure and failed to close the door to the room with the fire.

The bedroom doors were not self-closing doors. As a result, there was no safety net for correcting the in-house emergency responders' failure to close the door. If the door had been closed, this would have limited the smoke spread and would have had a positive influence on the survival conditions in the building.

Although the premises in itself actually complied with all the fire safety conditions, this fatal fire could still happen due to the fact that an integral approach to fire safety was lacking. The hospital management had failed to match the fire safety facilities to the degree to which patients would be able to leave without assistance and to consider the measures as an integrated complex.

To determine a building's purpose, the regulations discern between 'bedridden' and 'non-bedridden'. However, these concepts only consider the different forms and degrees of people who are affected in their ability to leave without assistance and they leave room for interpretation. In practice, this may add to healthcare institutions implementing measures that do not lead to the fire safety level required.

The report drawn up by the Dutch Safety Board can be found at <http://www.infopuntveiligheid.nl/Publicatie/DossierItem/14/3092/brand-in-rivierduinen-veronderstelde-veiligheid.html>  
The COT report can be found at <http://www.infopuntveiligheid.nl/Publicatie/DossierItem/14/1944/brand-bij-ggz-leiden.html>

**Description of the incident**

A fire took place at De Geinsche Hof nursing care centre in Nieuwegein in the early morning of 27 June 2011, at a time when a lot of clients and staff were present. 138 clients were evacuated in response to the fire. 52 people were examined in a hospital. Some people suffered physical complaints due to inhalation trauma and psychological complaints due to the events. De Geinsche Hof was temporarily unfit for habitation after the fire. The clients were housed in a temporary location.

The fire had a serious impact on everyone involved. Clients feared for their lives, and what they saw of the fire, the heavy smoke and the many emergency responders and their activities had a deep impact on them. The fire and the subsequent need to move house caused fear and unrest among the clients. The next of kin of clients feared for their relatives' lives during the fire and the evacuation. Some of them did not know what had happened to their relatives and where they were for quite some time after the evacuation. The staff of De Geinsche Hof, professional emergency responders and bystanders were very shocked by how helpless the people who needed to be evacuated were. What made a great impact on the staff was that the regular healthcare standards could no longer be complied with during the fire.

The investigation reconstructed the events of, and immediately after, 27 June 2011 and looked into the preliminary phase, i.e. the preparations for De Geinsche Hof, the permit file and other events related to the fire. The reconstruction sketches a picture of an incident that managed to develop in an unpredictable and, according to some people involved, unimaginable manner. All safety efforts taken by the hospital and the authorities involved did not prevent this incident from developing into an incident of such a large scale.

**Fire safety characteristics of the incident**

The building complied with the fire safety requirements of the permits. The building was being refurbished at the time of the fire. The requirements contained in the building permit were implemented, but there was no attention to fire safety during the refurbishing operation.

The fire started during roofing activities that qualify as fire-hazardous work. One of the consequences of the fact that no extra fire prevention measures had been taken during this work was that the air conditioning system was not switched off. As a result, a lot of smoke from the burning roof was blown into several fire compartments in the building.

The in-house emergency response organisation and the evacuation plan were up to par. However, the plan did not provide for a scenario where more than one smoke compartment would have to be evacuated. This resulted in the need to evacuate more people than the number of some thirty people the organisation had prepared for, and that full, i.e. also vertical evacuation was required, whereas the evacuation plan and organisation envisaged a partial and horizontal evacuation.

The COT report can be found at <http://www.infopuntveiligheid.nl/Publicatie/DossierItem/14/2947/onderzoeksreport-brand-geinsche-hof.html>

**Description of the incident**

Fire broke out at Koning Willem 1 Laan 114 in Hoofddorp, municipality of Haarlemmermeer, on the night of Friday to Saturday 16 August 2008. The fire spread to adjoining houses in both directions. Eight of the total of 13 houses in the block burnt out completely, two houses suffered smoke and water damage, while the other houses were unscathed. All residents managed to reach safety in good time. It was hard for the fire service to get the fire under control. This took them almost eleven hours.

During the fire, it was found that fire could easily spread in the direction of adjoining houses, without the fire service being able to effectively contain it. The houses' resistance to fire penetration and fire spread was found to be insufficient.

**Fire safety characteristics of the incident**

Upon discovering the initial fire, the resident left the house, leaving the back door open. Rather soon after the fire was discovered, a front window ruptured, making available sufficient oxygen to achieve full combustion.

The hot fire gases melted the polycarbonate skylight over the stairs due to which the roofing materials caught fire (chimney effect). The thin skylight casing only lasted for a few minutes, enabling the hot fire gases to accumulate between the plaster ceiling and the roof boarding. The plasterboards on the ceiling had limited fire resistance and burnt through after some time. The bituminous roofing at the roof upstand where the skylight was located caught fire and caused the insulating materials to burn as well. The timber roof structure, combined with the combustible polystyrene (EPS) and polyurethane (PUR) insulation materials resulted in very fast fire propagation in all directions. The presence of the hot fire gases between the plaster ceiling and the plywood roof boarding caused the local polystyrene (EPS) to melt and liquefy. The hot and liquid insulation materials acted as a flammable liquid and eventually penetrated through the joints between the boards where they contributed to the fire propagation between the ceiling and the rooms on lower levels.

The partitioning walls between the houses did not extend all the way to the roof boarding, but stopped at the level of the load-bearing joists where an overhead open space of some 4.5 cm was present. This meant that there was no fire resistance whatsoever between the houses. On their way to the ceiling, the hot fire gases heated the entire structure before escaping at the skylights and the feed-throughs in the roof for the vent pipes. The melting, liquefied insulation ran into the top floor of the adjoining houses in these locations, greatly promoting the fire.

The combination of the fact that there was no fire partition between the houses, and the roof structure consisting of two layers of combustible insulation materials of different compositions, i.e. two layers of bitumen and wood, resulted in an uncontrolled fire. Sawing through the roofing at a larger distance from the fire front that was located in the houses with the numbers 110 and 116 at that time, was the only proper solution to prevent the fire spreading further.

The reports drawn up by the Apeldoorn fire service and SAVE can be found at <http://www.infopuntveiligheid.nl/Publicatie/DossierItem/14/630/onderzoek-woningbrand-koning-willem-1-laan-hoofddorp.html>

#### Description of the incident

A fire raged in a block of houses in the Schiermonnikoog street in Zaandam on the night of Saturday 4 October to Sunday 5 October 2008. What was typical of this fire was that it quickly spread from one house into a massive fire, eventually involving six houses.

The fire developed in the kitchen on the ground floor at the back of a house. All materials in the kitchen contributed to the fire. Broken windows in the kitchen enabled the fire to reach the stage of a fully developed fire with temperatures of 600 to 900 °C. Flashover took place in this room because all the materials present in the kitchen caught fire.

#### Fire safety characteristics of the incident

The construction of the extension created an open connection (also via the vertically continuing voids in the wall structure) between the ground floor and the roof structure. This caused the hot fire gases and the fire to spread quickly in a vertical direction, and the hot fire gases could reach the roof boarding without being obstructed.

The room between the joists of the roof structure on the partitioning wall had not been finished to make it air tight. The faces of load-bearing joists could be seen on the other side of the partition wall. The joists were in line with each other or located next to each other, without the voids between them having been sealed. There were some points where the brickwork did not extend all the way to the roof boarding. The hot fire gases penetrated the adjoining houses through the holes and cracks in the connecting wall. When the roof of the house with the seat of the fire collapsed, parts of the connecting wall came loose, creating even larger openings to the adjoining houses.

There were wind speeds of 17.2 to 20.7 m/s during the fire. An underpressure was created in the adjoining houses, partly because some windows in those houses were open. This caused a suction effect, drawing the hot fire gases from the false ceilings towards those houses and this also contributed to the fast horizontal fire spread.

The report drawn up by the Apeldoorn fire service can be found at <http://www.infopuntveiligheid.nl/Publicatie/DossierItem/14/629/onderzoek-brand-schiermonnikoog-zaandam.html>

### Description of the incident

The central control room received a 112 call reporting a fire in a meter cabinet in a house at Het Hoge Licht 103 in Maassluis on Saturday morning, 11 August 2012, at 09:52. When arriving at the scene, the fire service found a fully developed fire on the ground floor of the house. Once the fire was under control, a major natural gas leakage was also found in the molten plastic gas mains pipe in the house.

On Wednesday 15 August 2012, another fire in a meter cabinet at Het Hoge Licht was reported to the fire service. This time it was at house Number 50. The fire service did not find a fully developed fire here, but an incipient fire due to an earth leakage circuit breaker that had partly molten.

A further inquiry revealed that several problems had occurred in this neighbourhood within a short period of time. These were mainly minor electricity interruptions, 'beeping' smoke detectors or smoke detectors that went off spontaneously, and defects in equipment plugged in to wall sockets. Some minor gas leaks and low water pressure in the water mains had also been reported.

### Fire safety characteristics of the incident

#### *Cause of the fire*

The fires at Number 103 and Number 50 were probably caused by a faulty contact in the screw connection of an earth leakage circuit breaker resulting in contact resistance and local overheating. No traces and/or clues pointing to a non-technical cause or overload of the systems in the houses were found.

Further investigation of earth leakage circuit breakers of the same brand in houses in the direct area did not reveal any other defects. However, checks commissioned by the BAM building company shortly after the fire revealed loose wires in three houses, due to screws not having been tightened. According to the board of VVE Havenloods, the owners' association, earlier checks commissioned by the residents had also revealed loose wires in six other houses.

#### *Fire growth*

The fire in the meter cabinet caused burning fragments to fall down onto the plastic PE gas pipes downstream of the meter, causing them to catch fire as well. This secondary (gas) fire also weakened the PVC pipe sleeve of the double-walled connection pipe at the bottom of the meter cabinet, causing it to shift downwards. This caused two leaks in the connection pipe upstream of the gas meter within less than ten minutes of the fire having been discovered.

The gas system at Number 103 had been constructed according to the NPR 3378-5:2007 Dutch Practical Guideline. Pursuant to table A4, plastic indoor gas pipes (Multilayer and PEX pipes) can only be used if they are concealed in the ground, floor, wall or a void that cannot be reached, or if they are "finished such that they can be reached" by fitting a pipe sleeve. However, the note to this table permits an exception to pipes in the meter cabinet. They do not have to be in a pipe sleeve, nor do they require heat resistant or thermally insulating protection. This means that the gas system complied with the legislation and regulations.

Due to this exception, the Practical Guideline insufficiently considers a fire starting in the actual meter cabinet and the increasing risks in the meter cabinet due to modems, routers, alarm systems, antenna amplifiers and other equipment of various qualities. This enables an incipient fire in the meter cabinet to very quickly escalate to a hazardous situation for its surroundings and for the fire service. As a result, the envisaged safety level referred to in article 6.2 of NEN 1078, i.e. that pipes must be designed and constructed such that, if a fire occurs, no explosion and/or significant intensification of the fire can occur, is not achieved.

The fire at Het Hoge Licht 103 is not an isolated event. A fire in a meter cabinet had already occurred in the Rotterdam-Rijnmond region on 21 October 2011 which caused a plastic connection pipe to burn through very quickly, resulting in a fierce gas fire and damaging the concrete structure. Similar examples are known from elsewhere in the country.

The report drawn up by the Rotterdam-Rijnmond Safety Region can be found at <http://www.infopuntveiligheid.nl/Publicatie/DossierItem/14/4631/brand-het-hoge-licht-103-maassluis-11-augustus-2012.html>





## Annex D Bibliography





## Bibliography

This knowledge document is the result of developments in the past few decades. The following and other sources were consulted and used when compiling this document. So as not to frustrate the legibility of this reference work and manual, no footnotes have been included in the text to identify the sources.

Aneziris, O., Baedts, E. de, et al. (2009) *Kwantitatieve risicoanalyse voor arbeidsveiligheid. De ontwikkeling van een risicomodel en software*. National Institute for Public Health and the Environment (RIVM), Bilthoven

Boven, P.L. van, et al. (1949). *Brandbeveiliging*. VUGA, Groningen

Brand, R. van den, Witloks, L, Kobes, M., (2005). *Leidraad gelijkwaardigheid en brandveiligheid*. Netherlands Institute for Safety (NIFV), Arnhem

BZK (1991). *Dutch Housing Act (Woningwet - Act of 29 August 1991 amending the Housing Act)*.

BZK (1994). *Brandbeveiligingsconcept cellen en cellen gebouwen*. Dutch Ministry of the Interior (BZK), The Hague

BZK (1994). *Brandbeveiligingsconcept woningen en woongebouwen*. Dutch Ministry of the Interior (BZK), The Hague

BZK (1995). *Brandbeveiligingsconcept gezondheidszorggebouwen*. Dutch Ministry of the Interior (BZK), The Hague

BZK (1995). *Brandbeveiligingsconcept gebouwen met een publieksfunctie*. Dutch Ministry of the Interior (BZK), The Hague

BZK (1995). *Brandbeveiligingsconcept industriegebouwen*. Dutch Ministry of the Interior (BZK), The Hague

BZK (1995). *Brandbeveiligingsconcept bedrijfshulpverlening*. Dutch Ministry of the Interior (BZK), The Hague

BZK (1995). *Brandbeveiligingsconcept beheersbaarheid van brand (inclusief reken- en beslismodel)*. Dutch Ministry of the Interior (BZK), The Hague

BZK (1996). *Brandbeveiligingsconcept logiesgebouwen en bijzondere woongebouwen*. Dutch Ministry of the Interior (BZK), The Hague

BZK (1996). *Brandbeveiligingsconcept kantoorgebouwen en onderwijsgebouwen*. Dutch Ministry of the Interior (BZK), The Hague

BZK (2009). *Eindrapport Actieprogramma Brandveiligheid 2007-2008*. Dutch Ministry of the Interior and Kingdom Relations (BZK), The Hague

BZK (2009). *Visie op brandveiligheid, gedeelde verantwoordelijkheid en heldere kaders vanuit een risicobenadering*. Dutch Ministry of the Interior and Kingdom Relations (BZK), The Hague

BZK (2011). *2012 Dutch Building Decree (Bouwbesluit 2012 - Decree of 29 August 2001, laying down regulations on building, occupying and demolishing buildings)*. Dutch Ministry of the Interior and Kingdom Relations (BZK), The Hague

BZK (2007). *Leidraad Repressie Brandweezorg/bijgewerkte conceptversie 6.4*. Dutch Ministry of the Interior and Kingdom Relations (BZK), The Hague

Cajot, L.G., Haller, M. and Pierre, M. (1994-1998). *Disseminatie van fire safety engineering kennis, deel 1: thermische & mechanische belastingen*. Difisek

CBS (1993-2012). *Brandweerstatiek (1992-2011)*. Statistics Netherlands (CBS), Voorburg/Heerlen

CCV (2010). *Model integrale brandveiligheid bouwwerken, handboek voor toepassing*. Dutch Centre for Crime Prevention and Safety (CCV), Utrecht

Alders Committee (2001). *Cafébrand Nieuwjaarsnacht*. Committee of inquiry into fire in Volendam on New Year's Eve 2001, The Hague

Dikkenberg, R. van den and Tonnaer, C. (2009). *Verbetering brandveiligheid, gebruik brandkrommen in Nederland*. Netherlands Institute for Safety (NIFV), Arnhem

Dikkenberg, R. van den, Post, J., Schaaf, J. van der and Tonnaer, C. (2012). *Verbeteren brandveiligheid, proof of concept cascademodel 2.0*. Netherlands Institute for Safety (NIFV), Arnhem

Groenewegen-ter Morsche, K., et al. (2008). *Kennis van het niveau van de kennis. Een onderzoek naar het kennis- en vaardighedenniveau van toetsers en adviseurs gelijkwaardigheid*. Netherlands Institute for Safety (NIFV), Arnhem

Hagen, R.R. and Witloks, L. (2005). *Essay deregulering bouwregelgeving brandveiligheid*. Netherlands Institute for Fire Service and Disaster Management (Nibra), Arnhem

Hagen, R.R. (2007). *Het kerkje van Spaarnwoude, over een nieuw elan in brandveiligheid in 10 ambities*. Netherlands Institute for Safety (NIFV), Arnhem

Hagen, R.R., Witloks, L., et al. (2009). *Visie op brandpreventie in de veiligheidsregio*. Netherlands Institute for Safety (NIFV), Arnhem

Hagen, R.R., Meijer, C.E., et al. (2011). *Nodeloze uitrukken terugdringen (onderzoek naar de consequenties van het voorstel herziening doormelding in het Bouwbesluit 2012)*. NIFV/NVBR, Arnhem

Hagen, R.R. (2013). *Dodelijke slachtoffers bij branden periode 2001 t/m 2012*. Netherlands Institute for Safety (NIFV), Arnhem

Helsloot, I., Oomes, E and Weewer, R. (2008). *Verkenkend onderzoek brand met dodelijke afloop in De Punt*

Herpen, R. van, Voogd, N., (2007) *Fysisch brandmodel. Achtergronden: Normalisatie fysische brandmodel Basismodel*. Adviesburo Nieman B.V. Zwolle

Hoogstraten, C.W. van and Sante, F.J. van (1960). *Enige beschouwingen over de grondslagen die een basis kunnen vormen voor door de overheid aan gebouwen te stellen brandveiligheidseisen*. TNO, Delft

Kobes, M. (2006). *Fire Safety Engineering, een innovatieve benadering van brandpreventie*. Utrecht University, Utrecht/Nibra, Arnhem

Kobes, M. et al. (2006). *Verkenning van simulatiemodellen, brand- en rookontwikkeling, evacuatie- en interventiemodellering*. Netherlands Institute for Safety (NIFV), Arnhem

Kobes, M, Groenewegen ter Morsche, K. (2008). *Zelfredzaamheid bij brand; tien mythen ontkracht*. Netherlands Institute for Safety (NIFV), Arnhem

Kobes, M. (2008). *Zelfredzaamheid bij brand, kritische factoren voor het veilig vluchten uit gebouwen*. Boom Juridische Uitgevers, The Hague

Kobes, M. (2010). *Understanding human behaviour in fire, validation of the use of serious gaming for research into fire safety psychonomics*. VU University, Amsterdam

Kobes, M, Oberijé, N. (2010). *Analysemodel vluchtveiligheid, systematische analyse voor vluchtveiligheid uit gebouwen*. Netherlands Institute for Safety (NIFV), Arnhem

Kobes, M., Rosmuller, N., et al. (2006-2008). *Verkenning van simulatiemodellen: Brand- en rookontwikkeling, evacuatie- en interventiemodellering*. Netherlands Institute for Safety (NIFV), Arnhem

Kobes, M., et al. (2008). *Dossierstudie Simulatie, Studie bij gemeenten naar de beoordeling van gelijkwaardige brandveiligheid met simulatie en rekenmodellen*. Netherlands Institute for Safety (NIFV), Arnhem

Leur, P.H.E. van de, Oerle, N.J. van (1995). *Rookverspreiding en warmteoverdracht bij brand*. Stichting Bouwresearch (Building research foundation), Rotterdam

Martinez de Aragon, J.J., Rey, F. and Chica, J.A. (1994-1998). *Disseminatie van fire safety engineering kennis, deel 4: software voor het brandveiligheidsontwerp*. Difisek

Mierlo, R.J.M. van (1991). *Rookafvoer uit hoge ruimten: ontwerpregels/rekenmethoden*. Stichting Bouwresearch (Building research foundation), Rotterdam

Mil, B.P.A. van, Dijkzeul, A.E., Pennen, R.M.A. van, et al. (2006). *Zicht op risico's - Handboek risicoanalysemethodieken*, Berenschot/TU-Delft, Utrecht

NBDC (2013). *Overzicht fatale branden in Nederland*. Dutch National Fire Service Documentation Centre (NBDC), website [www.nbdc.nl](http://www.nbdc.nl)

NBDC (2013). *Geschiedenis brandpreventie*. Dutch National Fire Service Documentation Centre (NBDC), website [www.nbdc.nl](http://www.nbdc.nl)

NEN (1995). *NEN 6093:1995, Brandveiligheid van gebouwen – beoordelingsmethode van rook- en warmteafvoerinstallaties*. NEN, Delft

NEN (2011). *NEN 6055:2011, Thermische belasting op basis van het natuurlijk brandconcept – bepalingsmethode*. NEN, Delft

NEN (2011). *NEN-EN 1991-1-2+C1:2011/NB:2011, National annex to NEN-EN 1991-1-2+C1. Eurocode 1 - Actions on structures - Part 1-2: General actions - Actions on structures exposed to fire*. NEN, Delft

NEN (2012). *NEN 6098:2012, Rookbeheersingssystemen voor mechanisch geventileerde parkeergarages*. NEN, Delft

NIFV (2007). *Brandveiligheidsvisie gezondheidszorg, Handreiking Brandweer, beleidsadvies (concept)*. Netherlands Institute for Safety (NIFV), Arnhem

NIFV (2007). *Brandveiligheid in cellen en cellingebouwen (concept 2.0), Leidraad*. Netherlands Institute for Safety (NIFV), Arnhem

NIFV (2009). *Brandveiligheid in cellen en cellingebouwen, Deskundigenadvies*. Netherlands Institute for Safety (NIFV), Arnhem

NIFV (2008-2012). *Presentaties nationale congressen fire safety engineering 2008-2012*. Netherlands Institute for Safety (NIFV), Arnhem

NVBR (2010). *De brandweer over morgen, strategische reis als basis voor vernieuwing*. Dutch Association for Fire Service and Disaster Relief (NVBR), Arnhem

NVBR (2010). *Brandbeveiligingsinstallaties*. Dutch Association for Fire Service and Disaster Relief (NVBR), Arnhem

NVBR (2012). *Handreiking Terugdringen van Ongewenste en Onechte Meldingen (TOOM)*, Nederlandse Vereniging voor Brandweer en Rampenbestrijding, Arnhem

Oerle, N.J. van, Janse, E.W., Leur, P.H.E. van de (1996). *Richtlijn vultijdenmodel grote brandcompartimenten, deel 1 t/m 4*. TNO Centre for Fire Safety, Rijswijk

Onderzoeksraad voor Veiligheid (2006). *Brand cellencomplex Schiphol-Oost (eindrapport van het onderzoek naar de brand in het detentie- en uitzetcentrum Schiphol-Oost in de nacht van 26 op 27 oktober 2005)*. Onderzoeksraad voor Veiligheid (Dutch Safety Board), The Hague

Onderzoeksraad voor Veiligheid (2009). *Brand De Punt (onderzoek naar het verongelukken van drie brandweerlieden bij het bestrijden van een brand in De Punt op 9 mei 2008)*. Onderzoeksraad voor Veiligheid (Dutch Safety Board), The Hague

Onderzoeksraad voor Veiligheid (2012). *Brand in Rivierduinen: veronderstelde brandveiligheid*. Onderzoeksraad voor Veiligheid (Dutch Safety Board), The Hague

Oomes, E. (2006). *De vanzelfsprekendheid van alledag, een beschouwing in drie delen over de gewoonten van het brandweervak*. Netherlands Institute for Safety (NIFV), Arnhem

Open University of the Netherlands (1998). *Risico's: besluitvorming over veiligheid en milieu*. Heerlen

Cieraad, C.D.J., Veek, J.H. van der, Haas, C.E. (2007). *Beheersbaarheid van brand. Deel 1: Methode Beheersbaarheid van brand, Integrale Leidraad. Deel 2: Toepassingsinstructie, Toelichting, praktijkinformatie. Deel 3: Afwegingsmodel, Complexe situaties*. Oranjewoud/SAVE, V2BO-advies, EFPC, Deventer

Overveld, M. van, Graaf, P.J. van der, Eggink, S. and Berghuis, M.I. (2011). *Praktijkboek Bouwbesluit 2012*. Sdu Uitgevers b.v., The Hague

SBR (1982). *Een brandveilig gebouw ontwerpen, handleiding voor ontwerpers*. Stichting Bouwresearch (Building research foundation), Rotterdam

SBR (1984). *Menselijk gedrag bij brand (B 29-2)*. Stichting Bouwresearch (Building research foundation), Rotterdam

Scherjon, J.W., Hagen, R.R., Witloks, L. (1999). *Brandpreventie in een andere dimensie*. Netherlands Institute for Fire Service and Disaster Management (Nibra), Arnhem

Schleich, J.B. et al. (2001). (Twilt, L. translation). *Valorisatie project, Natuurlijk Brandconcept*. ProfilArbed s.a., Luxembourg

Soomeren, P. van, Stienstra, H., et al. (2007). *Menselijk gedrag bij vluchten uit gebouwen*. DSP-groep/SBR, Amsterdam/Rotterdam



Straalen, IJ., Schraven, J., et al. (2008). *Regels voor resultaat*. NIFV/Efectis/TNO, Delft

SZW (1997). *Working Conditions Decree (Arbeidsomstandighedenbesluit - Decree of 15 January 1997 laying down rules in the interests of safety, health and wellbeing related to work.)*

SZW (1999). *1998 Working Conditions Act (Arbeidsomstandighedenwet 1998 - Act of 18 March 1999 laying down provisions to improve working conditions).*

Sozawe (2012). *Brochure Storeybuilder, Leren van ongevallen*. Dutch Ministry of Social Affairs and Employment (SZW, Sozawe), The Hague

Suurenbroek, Y. (2010). *Grote gebouwen, grote branden*. Saxion University of Applied Sciences, Enschede

Twilt, L. (1994-1998). *Disseminatie van fire safety engineering kennis, deel 2: thermische response*. Difisek

Veld, L. van het, Ham, K., et al. (2005). *Risico's en Risicoanalyse, nader toegelicht*. TNO, Apeldoorn

VenJ (2010). *Safety Regions Act (Wet veiligheidsregio's - Act of 11 February 2010 laying down provisions for the fire service, disaster response, crisis management and medical assistance)*

VenJ (2010). *Safety Regions Decree (Besluit veiligheidsregio's - Decree of 24 June 2010 laying down provisions on the fire service, disaster response, crisis management and medical assistance)*

Vliet, V.M.P. van, Kobes, M., Schokker, J.J. (2007). *Staalkaart adviesbureaus. Onderzoeksprogramma Simulatie*. Netherlands Institute for Safety (NIFV), Arnhem

VNG (2011). *Model-bouwverordening (14e serie wijzigingen MBV 1992)*. Association of Netherlands Municipalities, The Hague

VROM-Inspectie, et al. (2011). *Brandveiligheid van justitiële inrichtingen, herhalingsonderzoek*. VROM-Inspectie, The Hague

VROM-Inspectie, et al. (2011). *Brandveiligheid van zorginstellingen*. VROM-Inspectie, The Hague

VROM (2007). *Handreiking grote brandcompartimenten*. Ministry of Housing, Spatial Planning and the Environment (VROM), The Hague

VROM (2007). *Achtergronden van de handreiking grote brandcompartimenten*. Ministry of Housing, Spatial Planning and the Environment (VROM), The Hague

VROM (2007). *Doelstellingen brandveiligheid grote brandcompartimenten*. Ministry of Housing, Spatial Planning and the Environment (VROM), The Hague

Weges, J., et al. (2003). *Miljoenenbranden*. Netherlands Institute for Fire Service and Disaster Management (Nibra), Arnhem

Witloks, L., et al.(2009). *Visie op Bedrijfs hulpverlening: werken vanuit (brand)scenario's. Document voor educatie*. Netherlands Institute for Safety (NIFV), Arnhem

Zhao, B. (1994-1998). *Disseminatie van fire safety engineering kennis, deel 3: mechanische response*. Difisek

